

TULSA-PRO[®]



TULSA-PRO[®] Transurethral Ultrasound
Ablation System

Instructions for Use

PROFOUND



Publisher's Notice

TULSA-PRO® SYSTEM

Model Number: **PAD-105**

TULSA-PRO® Instructions For Use

Document Number: **102301 REV W**

Change Control Number: CO-06667

Revision Date: 2023-12

Published By:



Profound Medical Inc.
2400 Skymark Avenue, Unit 6
Mississauga ON L4W 5K5

Phone: 647-476-1350

Fax: 647-847-3739

<http://www.profoundmedical.com/>



EUROPEAN AUTHORIZED REPRESENTATIVE:

MDSS GmbH
Schiffgraben 41
30175 Hannover, Germany

SWISS REPRESENTATIVE:

MDSS CH GmbH
Laurenzenvorstadt 61
5000 Aarau, Switzerland

Copyright © 2023 Mississauga, Canada.

All rights reserved. No part of this document may be reproduced or transmitted in any form or by any means, electronic, mechanical, photocopying, recording, or otherwise, without prior written permission from Profound Medical Inc.



Federal law restricts this device to sale by or on the order of a Physician.

Table of Contents

PUBLISHER’S NOTICE	2
TABLE OF CONTENTS	3
1. ACRONYMS, ABBREVIATIONS, GLOSSARY, AND SYMBOLS	6
1.a Acronyms and Abbreviations	6
1.b Selected Glossary	6
1.c List of Symbols.....	7
1.d List of Indicators.....	10
1.d.i System Electronics Enclosure	11
1.d.ii Treatment Delivery Console – Status Bar Signal Indicators	12
1.d.iii TDC Status Bar Signals – Priority and Status Indicators.....	13
2. DOCUMENT SCOPE AND USE	14
2.a Scope.....	14
2.b.i Intended use	14
2.b.ii Indication for use	14
2.b.iii Intended Patient Population.....	14
2.b.iv Intended user	14
2.c Claims made on clinical performance and clinical safety for TULSA PRO:.....	15
3. CONTRAINDICATIONS	16
3.a MRI Eligibility.....	16
3.b General Anesthetic	16
3.c Prostate Gland Size and Tissue.....	16
3.c.i Prostate Tumors	17
3.d Special Conditions.....	17
4. CLINICAL SUMMARY	18
4.a Clinical Studies and Adverse Event Profile	18
4.a.i Safety: Adverse Events	18
4.b Prostate Volume Reduction.....	21
4.c PSA Reduction	22
4.d Prostate Biopsy at 12 months.....	22
5. DEVICE DESCRIPTION	23
5.a About the TULSA-PRO® System	23
5.b System Components	24
5.b.i Capital Equipment	24
Treatment Delivery Console (TDC) Software.....	25

System Cart (SC).....	26
System Electronics (SE).....	26
Fluid Circuit and Tube Sets	27
Positioning System (PS)	27
Filter Box.....	28
5.b.ii Single-use Disposable Devices.....	28
Transurethral Ultrasound Applicator (UA)	29
Example.....	30
Endorectal Cooling Device (ECD)	30
Patient-Contacting Parts.....	31
6. WARNINGS AND CAUTIONS	32
6.a Warnings	32
6.b Cautions	34
6.b.i Equipment Setup.....	34
6.b.ii Therapy Related – Patient Preparation	42
6.b.iii Therapy Related – Treatment Planning.....	46
6.b.iv Therapy Related – Treatment Delivery	47
6.b.v Therapy Related – Post Treatment.....	49
7. OPERATING INSTRUCTIONS	51
8. OPERATING AND STORAGE CONDITIONS.....	52
8.a System Operating Parameters	52
8.b System Storage and Transport Conditions for Disposables (UA, ECD, Tube-Sets, and ECD Fluid Supplement).....	52
8.c System Storage and Transport Conditions (excluding UA, ECD, and Tube-Sets) ..	52
8.d Power Requirements	52
8.d.i System Electronics.....	52
8.d.ii Treatment Delivery Console (TDC) Computer.....	52
8.e Electronic Interfaces	53
8.e.i System Electronics.....	53
8.e.ii Treatment Delivery Console (TDC) Computer.....	53
8.e.iii Ethernet Network Integrity, Performance and Functional Requirements ..	53
8.e.iv Data Exchange	54
8.e.v Time Synchronization	54
8.e.vi IT Personnel Training or Qualifications	54
9. SERVICE AND MAINTENANCE.....	55
9.a Cleaning.....	55

9.b Calibration and Maintenance	55
9.b.i Fuse Replacement	55
9.c System Life and Ongoing Maintenance.....	56
9.d Anti-virus Scanning on TDC Computer.....	56
9.e Service and Replacement Parts.....	56
APPENDIX A. MRI SEQUENCES	58
APPENDIX B. SPECIFICATION SHEET	59
APPENDIX C. REGULATORY COMPLIANCE.....	62
Reporting of Serious Incidents.....	63
APPENDIX D. ULTRASOUND BEAM PROFILE	68
Test conditions.....	68
Ultrasound profile in water	68
Typical Temperature Profile	70
APPENDIX E. TULSA-PRO® EDUCATION PROGRAM	71
Purpose of the Program.....	71
Training Outline and Formats	71
APPENDIX F. EQUIPMENT AND ACCESSORIES.....	73

1. Acronyms, Abbreviations, Glossary, and Symbols

1.a Acronyms and Abbreviations

This manual uses the following abbreviations:

ECD	Endorectal Cooling Device
E(#)	Ultrasound Applicator element
FC	Fluid circuit
FOV	Field of view
MR	Magnetic Resonance
MRI	Magnetic Resonance Image/Imaging/Imager
M(#)	Monitoring element
PS	Positioning System
PSIB	Positioning System Interface Box
TDC	Treatment Delivery Console software
RF	Radio Frequency
SC	System Cart (Fluid Circuit + System Electronics)
SE	System Electronics
TULSA	MRI- guided Transurethral Ultrasound Ablation of the prostate
TULSA-PRO®	Transurethral Ultrasound Ablation System
UA	Ultrasound Applicator

1.b Selected Glossary





TERM	DEFINITION
Warning	A potentially hazardous situation which, if not avoided, could cause death or serious injury.
Caution	A potentially hazardous situation, which, if not avoided, could cause minor or moderate injury. Also used to alert against unsafe practices.
Control boundary	The boundary used by software to achieve acute, thermal coagulation of all tissue between the urethra and prostate boundary. The TULSA-PRO® system raises the temperature of all tissue between the urethra and the control boundary to at least the control temperature.
Control temperature	The temperature to reach during the thermal ablation procedure at the control boundary of the control volume. Control temperature

1. Acronyms, Abbreviations, Glossary, and Symbols















	default is 57°C. If Thermal Boost is enabled (per ultrasound element for prostate radius > 15 mm), control temperature is variable from 57°C to 65°C in the user-selected region.
Control volume	The volume within the prostate that is planned to reach or exceed the control temperature.
MR thermometry	The process of creating thermal images from MRI data.
Profound Medical authorized service personnel or representative	A group or person who has authority from Profound Medical to perform service and maintenance activities on the TULSA-PRO® System.
Prostate boundary	The defined boundary that represents the prostate tissue targeted for thermal ablation.
Targeting accuracy	The spatial difference between the control volume and the control temperature isotherm measured on MR thermometry images, as acquired during treatment.
Thermal dose	The thermal dose is a cumulative, quantitative measure of temperature exposure. It is a function of the duration and intensity of heating and is measured in units of Cumulative Equivalent Minutes of heating at 43°C (CEM43). Different heating profiles that generate the same thermal dose cause similar therapeutic effects (such as cell kill). For example, for each 1°C increase above 43°C, the time required to induce cell kill is halved. A thermal dose of 240 CEM43 is considered to provide complete cell kill of most soft tissues.

1.c List of Symbols













In the following table, you might see any of the symbols on TULSA-PRO® System components or on package labels for TULSA-PRO® System components and accessories.

SYMBOL	DESCRIPTION
	Catalogue number, reference number
	Lot number, batch code
	Serial number
	Quantity in package
	Manufacturer name and address





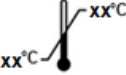





1. Acronyms, Abbreviations, Glossary, and Symbols

	Date of manufacture
	Country of manufacture <i>CC indicates Country Code and will be replaced by a two-letter country code to identify the country of manufacture.</i>
	Use by date; expiry date
	Caution, attention
	Consult <i>Instructions for Use</i>
	Sterilized using ethylene oxide
	Single, sterile barrier system
	Non-sterile
	Single use, do not reuse
	Do not re-sterilize
	Do not use if package is damaged
	MR safe An item that poses no known hazards after exposure to an MR environment
	MR unsafe An item which poses unacceptable risks to the patient, medical staff, or other persons within the MR environment
	MR unsafe An item which poses unacceptable risks to the patient, medical staff, or other persons within the MR environment

1. Acronyms, Abbreviations, Glossary, and Symbols

	
 	<p>MR conditional</p> <p>An item with demonstrated safety in the MR environment within defined conditions. Additional conditions, including specific configurations of the item, might be required.</p>
	Do not place any heavy objects on the surface
	Type BF applied part
	Equipment can emit non-ionizing radiation
 V: ___ A: ___ Hz: ___ W: ___	Alternating current input Electrical rating: Voltage, Amperage, Frequency (Hz), Power (W)
	Maximum fill volume of the Endo-rectal Cooling Device (ECD) balloon is 30 ml
	Mobile equipment mass including safe working load
	Fragile
	Keep dry
	Upper and lower temperature limits
	Upper and lower humidity limits
IPX1	<p>Ingress Protection Rating</p> <p><i>Found on Profound Medical equipment to rate the degree of protection against water intrusion. See the IP symbol on each piece of equipment for specific water rating.</i></p>

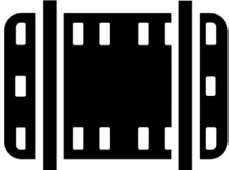
1. Acronyms, Abbreviations, Glossary, and Symbols

	<p><i>X – No rating for ingress of solid particles</i></p> <p><i>1 – Protection against ingress of vertically dripping water</i></p> <p><i>7 – Protection against ingress when the device is fully immersed in water</i></p>
	Federal (United States) law restricts this device to sale by or on the order of a Physician
	Medical device
	<p>Unique device identifier</p> <p><i>Indicates a carrier that contains unique device identifier information.</i></p>
	<p>CE mark and notified body number</p> <p>Indicates conformity of devices with the provisions of the Medical Device Directive, which enables them to move freely within the European Community and be put into service according to their intended purpose.</p>
	Authorised representative in the European community
	Authorized representative in Switzerland
	<p>Importer</p> <p><i>Address next to this symbol indicates the entity that imported the medical device into the locale.</i></p>
	Patient Strap
	MRI Body Coil strap
	PHK Base Plate, Patient Pad strap

1.d List of Indicators

The tables below describe indicator colours and symbols that appear on TULSA-PRO® System components or software displays. Components are located on the System Cart (*Figure 1*).



Figure 1: System Cart and components

1.d.i System Electronics Enclosure

Refer to *Figure 2* to see where the indicators are on the **front panel** of the System Electronics enclosure.

INDICATOR COLOUR & NAME	MEANING
Yellow - "DISABLE"	Stop button has been activated to disable the output from amplifiers
Red - "STOP"	Emergency stop switch has been activated. RF output and fluid pumps are disabled
Yellow - "OVER-TEMPERATURE"	Amplifier has exceeded temperature threshold
Green - "MAIN POWER"	Power is on and the system is ready for use
Blue - "RF POWER"	RF power is being delivered

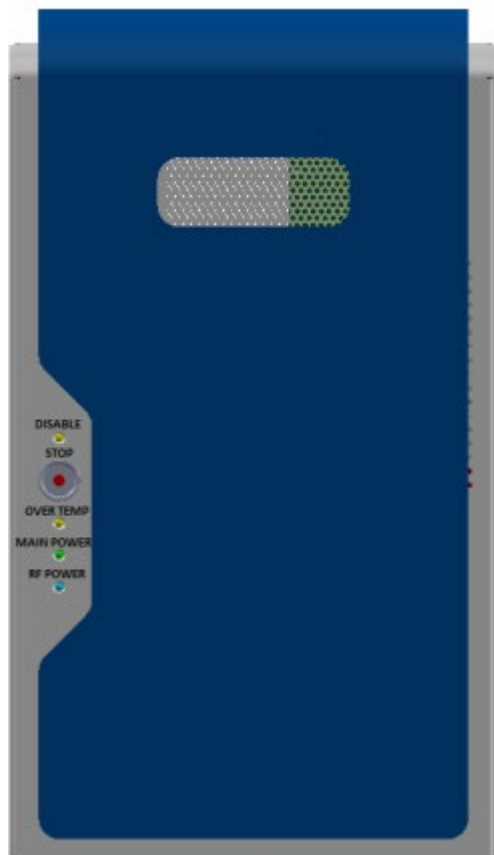

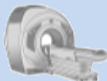

Figure 2: Front of System Electronics enclosure with indicators

1.d.ii Treatment Delivery Console – Status Bar Signal Indicators

The Status Bar Signal indicators show alarm or information signals. The Status Bar Signal indicators appear at bottom-left corner of the Treatment Delivery Console (TDC) screen.

INDICATOR	MEANING
	Fluid Circuit (communication link, pressure, volume, temperature)
	Positioning System (communication link, axis fault, rotational error, UA attachment state, UA temperature)
	Imaging System (communication link, temperature uncertainty, image delay, phase drift, image scanning event, thermometry scan origin mismatch, temperature masking, thermometry header data, MRI cartridge compatibility)

1. Acronyms, Abbreviations, Glossary, and Symbols



Radio Frequency electronics (communication link, net power deviation, reflected power, UA connection state)



Patient Interface treatment signal related to the state of MRI field of view



General System signal related to state of the TDC host system

1.d.iii TDC Status Bar Signals – Priority and Status Indicators

Background colours and icons appear to draw attention to the Status Bar Signal Indicators, as shown in the *Figure 3*.

INDICATOR BACKGROUND COLOUR	STATUS ICON	MEANING
Orange		Warning condition, operator should take prompt action
Orange		Communication warning, connection cannot be established with a remote subsystem
Light Blue		Information signal
Default system (white background)	No icon	No active messages

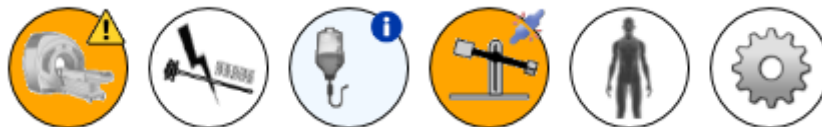

Figure 3: Example of Status Bar Signal Indicators

From left to right: Imaging System – warning condition requiring action; RF Electronics – no active message; Fluid Circuit – information signal, no action required; PS – communication warning that a subsystem is disconnected; Patient System – no active message; TDC Host System – no active message.

2. Document Scope and Use

2.a Scope

This document describes the TULSA-PRO® Transurethral Ultrasound Ablation System, its intended use, and all regulatory information about the TULSA-PRO® system, including warnings and cautions that are essential for the safe and proper use of this medical device system.

All users of the TULSA-PRO® System **must** read this entire manual and accompanying TULSA-PRO® Operator's Manual, especially all safety-related information, before handling or operating any part of the system.

2.b.i Intended use

The TULSA-PRO® System is intended for transurethral ultrasound ablation (TULSA) of prostate tissue.

2.b.ii Indication for use

TULSA-PRO® is indicated for thermal ablation of prescribed prostate tissue, benign and malignant, using transurethral ultrasound ablation (TULSA) with in-bore real-time MRI treatment planning, monitoring, visualization, thermal dosimetry, and active temperature feedback control of thermal treatment.

2.b.iii Intended Patient Population

"TULSA-PRO intended target population are men with prostate disease."

2.b.iv Intended user

The TULSA-PRO® System should be used by a medical professional within a commercial or hospital shielded MRI environment. When interpreted by a trained physician, the TULSA-PRO® System provides information that can help in determining or assessing the thermal therapy. The intended users of the TULSA-PRO device are the following personnel: urologist, radiologist, anesthesiologist, MRI technologist. All four personnel or their equivalent are required to perform the procedure.



NOTE: Patient management decisions should not be made solely on the basis of the TULSA-PRO® software analysis.

2.c Claims made on clinical performance and clinical safety for TULSA PRO:

The TULSA-PRO provides customizable, incision-free ablation of prescribed prostate tissue. Specifically, the TULSA-PRO offers:

1. Prostate ablation through thermal coagulation providing cell kill indiscriminate of prostate tissue type (benign and malignant tissues), while sparing nearby critical anatomy;
2. Prostate ablation with low morbidity and low complications ;
3. Treatment with rapid recovery time (typical: hospital discharge within 24 hours, and return to baseline urinary and bowel quality of life within 3 months);
4. Millimeter accuracy and precision of ablation. Conformal thermal ablation of target prostate volumes is achieved with an accuracy and precision ± 1 mm;
5. Fast ablation of prescribed prostate ablation volume up to 125 cc. Median 51 min ablation for median 40 cc volume (1.3 min / cc);
6. Minimally-invasive, incision-free transurethral thermal ablation to heat the prostate from the inside-out;
7. In-bore real-time MRI treatment planning, monitoring, visualization, thermal dosimetry, and active temperature feedback control of thermal treatment;
8. Quantitative thermal dosimetry with median 97.6% ablative thermal dose coverage of prescribed prostate tissue;
9. Effective volume reduction of prescribed prostate tissue. Median 92% prostate volume reduction with sparing of the urethra and urinary sphincter; and
10. Local control of clinically significant primary or radiorecurrent disease, with significant PSA reduction and low rates of residual cancer on histopathology (follow-up biopsy).
11. Relief of urinary symptoms in men who are symptomatic pre-treatment.

3. Contraindications



It is the responsibility of the treating physician to convey the following contraindications and limitations to the patient.

3.a MRI Eligibility

Patients receiving TULSA therapy with the TULSA-PRO® System **must** be:

- eligible for magnetic resonance imaging
- screened by a Magnetic Resonance Imaging (MRI) professional (technologist or radiologist) before entering the MRI suite for treatment.

Some contraindications to MRI eligibility include (but are not limited to):

- implants that are electrical or metallic (such as pacemaker, aneurism clip, or cochlear implant)
- metal fragments in the body (such as from previous metal-working experience or shrapnel)

3.b General Anesthetic

Patients receiving TULSA therapy with the TULSA-PRO® System must be eligible for general anesthetic. An anesthesiologist must assess patients before treatment for any medical condition that would make them ineligible for general anesthetic.

3.c Prostate Gland Size and Tissue

The requirements that make the prostate gland size and tissue properties suitable for TULSA-PRO® treatment can vary. It is recommended to confirm suitability of the prostate size and tissue properties on a pre-treatment, (trans-rectal ultrasound, MRI or CT-scan image) **before** using the TULSA-PRO® System.

As a guideline for a single treatment with the TULSA-PRO® System:

- If treating of a whole prostate gland, the prostate volume should be no greater than 90 cc. Men with very large prostates should not be excluded if the goal of TULSA treatment is partial gland ablation with a target ablation volume no greater than 90 cc.
- the prostate gland size should be no greater than 5 cm long (cranial/caudal or superior/inferior) and 6 cm in axial diameter (left/right and anterior/posterior). The maximum extent of thermal ablation is 3 cm in radial distance from the UA center.
- the prostate gland tissue must not contain cysts or calcifications greater than 1 cm. Ideally, there should be no calcifications in the planned ultrasound beam path.

3. Contraindications

3.c.i Prostate Tumors

Patients with prostate tumor that extends beyond the prostate capsule, seminal vesicle invasion, or metastases are **not** candidates for TULSA therapy. The prescribing physician is responsible for disease diagnosis and risk stratification of disease.

3.d Special Conditions

- Patients interested in future fertility
- Active urogenital infection
- Urinary tract or rectal fistula
- Abnormality making it difficult to insert the Endorectal Cooling Device (ECD) such as anal or rectal fibrosis or stenosis
- Abnormality making it difficult to insert the Ultrasound Applicator (UA) such as urethral stenosis
- Presence of implants in or adjacent to the prostate that would interfere with the ultrasound beam path (such as radioactive seed implants, artificial sphincter, penile prosthesis, or intraprostatic implant)



The TULSA-PRO® System must be used by a qualified medical professional upon the prescription and under the supervision of a physician who has successfully completed the Profound Medical training program, is experienced in clinical thermotherapy, and in accordance with the **TULSA-PRO® Instructions For Use** and **TULSA-PRO® Operator's Manual**.

You can find additional warnings and cautions at "Warnings and Cautions" on page 32.

4. Clinical Summary



It is the responsibility of the treating physician to convey the following contraindications and limitations to the patient.

4.a Clinical Studies and Adverse Event Profile

The TULSA-PRO has been evaluated in prospective clinical trials, including the TACT Pivotal Study which was designed to determine the safety and effectiveness of the device according to the proposed intended use. Between September 2016 and February 2018, the TACT study enrolled 115 patients across the United States, Canada and Europe with biopsy-proven, organ-confined prostate cancer (67.0% and 33.0% of subjects had NCCN intermediate and low risk disease, respectively). All patients received primary treatment of whole-gland prostate ablation with sparing of the urethra and urinary sphincter. The median age of enrolled patients was 65 years, with targeted prostate volume of 40 cc and ultrasound treatment delivery time of 51 minutes. A median of 97.6% of the prescribed prostate volume was heated to an ablative thermal dose with spatial ablation precision of ± 1.4 mm measured on MRI thermometry during treatment.

The primary efficacy endpoint of TACT was the proportion of patients achieving a post-treatment PSA reduction $\geq 75\%$ of their pre-treatment baseline value. The primary safety endpoint was the frequency and severity of all adverse events graded according to the Common Terminology Criteria for Adverse Events (CTCAE). Secondary endpoints included prostate volume reduction, proportion of patients with negative biopsy, patient reported changes in quality of life (erectile, urinary and bowel function), and evaluation of multiparametric prostate MRI. Primary and secondary endpoints were assessed at 12 months after TULSA-PRO treatment, with per-protocol follow-up continuing to 5 years.

The TULSA-PRO device used to collect clinical data was developed and manufactured in accordance with requirements of ISO 13485 compliant Quality Management System. The prospective clinical studies were conducted in accordance with 21 CFR 812 regulations.

4.a.i Safety: Adverse Events

All Adverse Events (AE) were documented during the TACT study regardless of their attribution to the TULSA-PRO procedure. All AE's were evaluated according to the Common Terminology Criteria for Adverse Events (CTCAE) developed by the NCI and were standardized to medical terminology using the Medical Dictionary for Regulatory Activities (MedDRA). *Table 1: Summary of all adverse events in TACT* summarizes all AE observed during the TACT pivotal study through to the 12-month visit, regardless of severity or relation to the TULSA-PRO device or procedure. To 12 months, there was no rectal injury or fistula, and no severe urinary incontinence or erectile dysfunction. There were no Grade 4 or higher AE related or possibly related (attributable) to TULSA-PRO. There was one unrelated Grade 4 event of coronary artery disease resolved with a triple coronary artery bypass. There were 12 attributable Grade 3 AE in 9 patients (7.8%), all resolved by the 12 month follow-up. An additional 10 unrelated Grade 3 events occurred in 7 subjects, of which two were ongoing at 12 months: an upper GI bleed caused by esophageal adenocarcinoma which was resolving as of 12 months, and unrelated pelvic pain caused by a urinary stone which resolved after the 12 month visit.

4. Clinical Summary

The majority of attributable events were acute Grade 1 and 2 (occurring and resolving within 3 months of treatment), related to the genitourinary system. Urethral stenosis occurred in 3 subjects (one Grade 2 and two Grade 3, all resolved). Urinary tract infections were common and resolved with oral antibiotics in nearly all affected patients. Urinary retention occurred in 9 attributable Grade 2 events (7% of patients) and 2 attributable Grade 3 events (1.7%), all resolved with medication and prolonged catheterization up to a maximum of less than 3 months. Attributable gastrointestinal AE were limited to acute Grade 1 events and 7 acute Grade 2 events: pain/discomfort (3.5% of subjects), nausea (1.7%), and constipation (0.9%), all of which resolved within one month and could potentially be attributed to anesthesia or GI anti-spasmodic medication. No urethra-rectal fistula were reported during the TACT study or after any other TULSA-PRO treatment; however, it is a potential complication.

Erectile dysfunction and urinary incontinence are common events after prostate therapies. Erectile dysfunction after TULSA-PRO in the TACT study was expected due to the whole-gland nature of the ablation. Of the 52 patients (45.2%) with some erectile dysfunction immediately after TULSA-PRO treatment, 49 (42.6%) were assessed by the study investigators as attributable to TULSA-PRO, of which 41 (35.7%) were ongoing at the 12-month follow-visit: 14 patients (12.2%) had mild erectile dysfunction (Grade 1, intervention not indicated), 27 patients (23.5%) had moderate erectile dysfunction (Grade 2, intervention such as medication indicated), and no patient (0%) had severe erectile dysfunction (Grade 3, intervention such as medication not helpful) or permanent disability.

101 patients completed follow-up visits after two years, and the rate of moderate erectile dysfunction was 23%.

Of the 28 patients (24.3%) with some urinary incontinence immediately after TULSA-PRO treatment, 26 (22.6%) were assessed by the study investigators as attributable to TULSA-PRO, of which 12 (10.4%) were ongoing at the 12-month follow-visit: 9 patients (7.8%) had mild urinary incontinence (Grade 1, occasional, pads not indicated), 3 patients (2.6%) had moderate urinary incontinence (Grade 2, spontaneous, pads indicated), and no patient (0%) had severe urinary incontinence (Grade 3, operative intervention indicated) or permanent disability.

Ongoing attributable moderate (Grade 2) AE at 12 months included ejaculatory disorder (retrograde ejaculation, 2.6% of subjects), weak urinary stream (2.6%), urinary tract infection (1.7%), and disrupted urethra (0.9%, identified on cystoscopy).

The following table shows a summary of all adverse events in TACT including the number of patients with AE with any occurrence and ongoing at the 12-month follow-up visit. Multiple AE of the same name are listed once per patient using highest attributable grade, sorted by frequency.

Table 1: Summary of all adverse events in TACT

The number of patients with any occurrence of AE and ongoing at the 12-month follow-up visit. Multiple AE of the same name are listed once per patient using the highest attributable grade, sorted by frequency.

ADVERSE EVENT (AE)	ANY OCCURRENCE, REGARDLESS OF ATTRIBUTION # SUBJECTS (%) (N=115)	SUBSET OF AE ATTRIBUTABLE TO TULSA-PRO # SUBJECTS (%) (N=115)
Total	109 (94.8 %)	101 (87.8 %)
Erectile dysfunction	52 (45.2 %)	49 (42.6 %)
Haematuria	48 (41.7 %)	42 (36.5 %)

4. Clinical Summary

Urinary tract infection	42 (36.5 %)	32 (27.8 %)
Dysuria	29 (25.2 %)	21 (18.3 %)
Urinary incontinence	28 (24.3 %)	26 (22.6 %)
Pain/discomfort (pelvic/genital/treatment area)	27 (23.5 %)	25 (21.7 %)
Oedema (testicular, scrotal, penile)	27 (23.5 %)	24 (20.9 %)
Urinary urgency	26 (22.6 %)	25 (21.7 %)
Catheter site pain/inflammation	20 (17.4 %)	7 (6.1 %)
Pain/discomfort (abdominal/anorectal)	17 (14.8 %)	14 (12.2 %)
Urinary frequency	16 (13.9 %)	16 (13.9 %)
Bladder spasm	14 (12.2 %)	12 (10.4 %)
Ejaculation disorder	14 (12.2 %)	14 (12.2 %)
Non-descriptive LUTS	14 (12.2 %)	10 (8.7 %)
Urinary retention	13 (11.3 %)	10 (8.7 %)
Urethral bleeding	13 (11.3 %)	13 (11.3 %)
Pain/discomfort (hip/back)	12 (10.4 %)	9 (7.8 %)
Urethral discharge	11 (9.6 %)	11 (9.6 %)
Weak urinary stream	11 (9.6 %)	11 (9.6 %)
Pain/discomfort (bladder/urinary tract)	10 (8.7 %)	9 (7.8 %)
Fatigue	9 (7.8 %)	3 (2.6 %)
Hypotension	8 (7 %)	
Nausea	8 (7 %)	2 (1.7 %)
Epididymitis	7 (6.1 %)	7 (6.1 %)
Headache	7 (6.1 %)	2 (1.7 %)
Debris in urine	5 (4.3 %)	5 (4.3 %)
Orchitis	5 (4.3 %)	2 (1.7 %)
Constipation	4 (3.5 %)	2 (1.7 %)

4. Clinical Summary

Dyspepsia	4 (3.5 %)	
Fever	4 (3.5 %)	3 (2.6 %)
Hypertension	4 (3.5 %)	
Nocturia	4 (3.5 %)	3 (2.6 %)
Procedural hypotension	4 (3.5 %)	
Libido decreased	4 (3.5 %)	
Inguinal hernia	3 (2.6 %)	
Urethral stenosis	3 (2.6 %)	3 (2.6 %)
Calculus urinary	2 (1.7 %)	1 (0.9 %)
Hydronephrosis	2 (1.7 %)	1 (0.9 %)
Anaemia	1 (0.9 %)	
Syncope	1 (0.9 %)	
Upper gastrointestinal haemorrhage	1 (0.9 %)	
Urinoma	1 (0.9 %)	1 (0.9 %)
Urosepsis	1 (0.9 %)	
Deep vein thrombosis	1 (0.9 %)	1 (0.9 %)
Diverticulitis	1 (0.9 %)	
Ileus	1 (0.9 %)	
Other*	95 (82.6 %)	41 (35.7 %)

* Includes all non-serious Grade ≤ 2 events with occurrence in < 3% of all patients

4.b Prostate Volume Reduction

Prostate volume reduction was measured in the TACT study demonstrating effective ablation of the prescribed prostate volume. As per protocol, the TACT study employed a central radiology core lab to measure prostate volume prior to and after treatment with TULSA-PRO, providing consistent methodology and reducing inter-observer variability. In the TACT study, 106 of the 115 patients had MR image data prior to and after TULSA (at 12 months) that were available and readable by the central radiology core lab. Based on the per-protocol assessment from a central radiology core lab, the median (IQR) perfused prostate volume of patients in TACT decreased 91.4% from 37.3 (27.2 – 47.6) cc pre-treatment to 2.8 (1.7 – 4.7) cc at 12 months on MRI. The mean and 95% confidence interval of the prostate volume reduction was 89% (87 – 91%). Given the treatment intent of whole-gland ablation with sparing of the urethra and urinary sphincter, the prostate volume reduction measurements demonstrate that the TULSA-PRO achieved effective prostate tissue ablation.

4. Clinical Summary

4.c PSA Reduction

PSA reduction and stability provide additional evidence of effective prostate tissue ablation. Reduction of PSA was observed in all patients at nadir and at 12 months. Primary endpoint of PSA reduction $\geq 75\%$ was achieved in 110 of 115 (96%) patients. Mean (95% confidence interval) PSA reduction to nadir was 92% (90 – 94%). Median (IQR) PSA reduction was 95% (91 – 98%) to nadir of 0.34 (0.12 – 0.56) ng/ml. Median (IQR) PSA decreased from 6.26 (4.65 – 7.95) ng/ml to 0.53 (0.30 – 1.19) ng/ml at 1 month, remaining stable to 0.53 (0.28 – 1.25) ng/ml at 12 months.

4.d Prostate Biopsy at 12 months

Negative prostate biopsy outcomes provide additional evidence of effective prostate tissue ablation. Prostate histological response was evaluated through 10-core prostate biopsy at 12 months, providing high sampling density of the prostate due to the significant volume reduction after TULSA-PRO treatment. Of 115 patients enrolled in the study, 4 (3.5%) did not undergo follow-up biopsy, all due to patient refusal.

Using an intent-to-treat analysis (ITT), of 115 patients enrolled in the study, 72 (63%) had a complete histological response with no evidence of any cancer (95% confidence interval: 54 – 71%). For this ITT analysis, the 4 patients who refused follow-up biopsy were considered “positive”. Eight men whose one-year biopsy indicated incomplete ablation underwent additional treatment for prostate cancer without complications: 4 salvage radical prostatectomy, 3 external beam radiation therapy, and 1 brachytherapy. Predictors of clinically significant disease included presence of intraprostatic calcification at screening, thermal coverage during treatment, and suspicious MRI lesion at one-year multiparametric MR.

This data is consistent with the prescribed treatment plan, supports the substantial equivalence of the TULSA-PRO to its predicate, and demonstrates safety and effectiveness of the device for ablation of prostate tissue.

5. Device Description

5.a About the TULSA-PRO® System

The TULSA-PRO system combines real-time Magnetic Resonance (MR) imaging and MR thermometry with transurethral directional ultrasound and closed-loop process control software to deliver precise thermal ablation of physician prescribed prostate tissue (*Figure 4*). The system consists of both hardware and software components.

The transurethral ultrasound ablation (TULSA) treatment is delivered completely within the MR bore. A real-time MRI interface is used by closed-loop features of the TULSA-PRO system: real-time MRI prostate temperature measurements are processed by TULSA-PRO software which communicates with TULSA-PRO hardware, thereby controlling frequency, power and rotation rate of ultrasound to ablate physician prescribed prostate tissue with a high degree of precision.

The physician inserts two catheters, one transurethral and another transrectal, into the patient before he is moved into the MR bore. The transurethral catheter consists of an Ultrasound Applicator (UA) which delivers energy from within the prostate tissue, heating it to thermal coagulation. The transrectal catheter is an Endorectal Cooling Device (ECD), which does not emit any energy, and cools the rectal wall adjacent to the prostate. Both catheters have fluid flowing inside throughout the treatment to thermally protect the urethra and rectum, in order to minimize the potential of any thermal damage to either the urinary or rectal pathways.

The physician uses the TULSA-PRO console to robotically position the UA in the prostate and plan the treatment by contouring the prescribed tissue on real-time high-resolution cross-sectional MR images of the prostate. These features provide the physician with the ability and the control to customize the treatment plan to minimize thermal impact to critical structures surrounding the prostate including the external urethral sphincter, rectum and neurovascular bundles.

The treatment begins based upon the physician's instructions by enabling the software to initiate thermal ablation. The TULSA-PRO closed-loop process control software reads real-time MR thermometry measurements and adjusts automatically and dynamically the frequency, power and rotation rate of ultrasound provided by each UA transducer, to deliver precise ablation of the prescribed prostate tissue. The software controls automated, continuous and robotic rotation of the transurethral UA by 360 degrees in sync with the process-controlled delivery of thermal heating to all the required regions of the prostate. Following completion of the ablation process, the two catheters are removed from the natural orifices of the patients.

5. Device Description

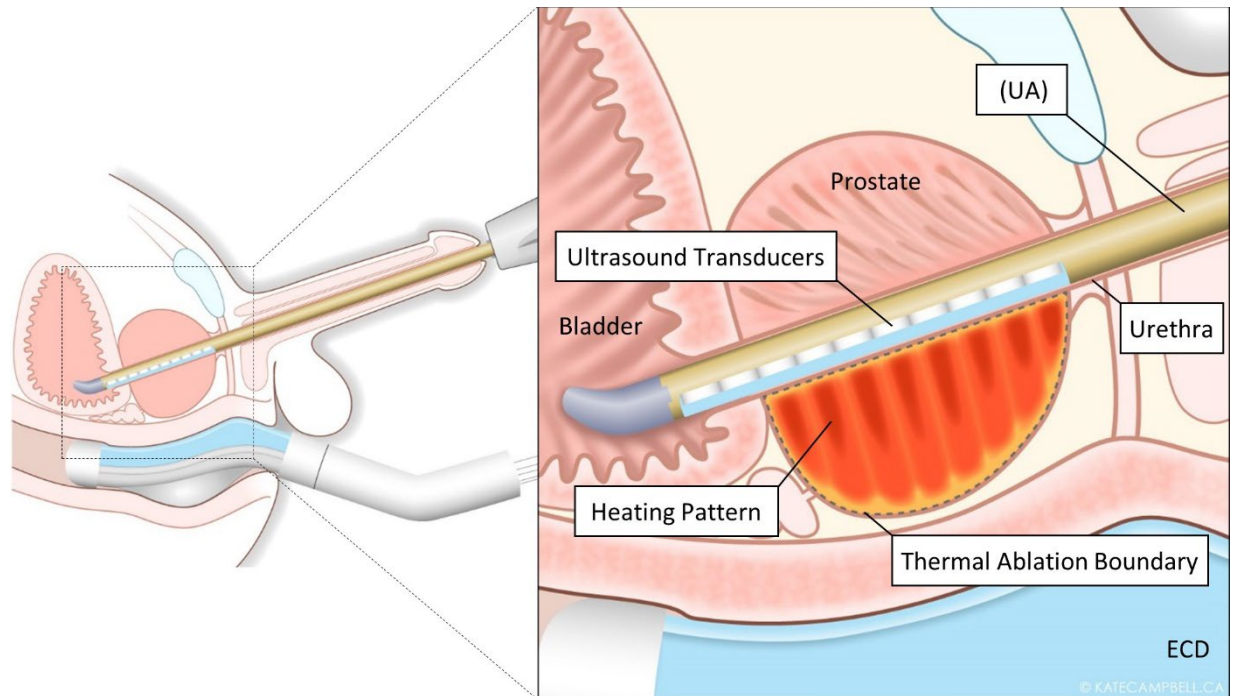

Figure 4: Concept diagram of UA in prostate

5.b System Components

The TULSA-PRO® System consists of:

- capital equipment
- single-use disposable devices.

5.b.i Capital Equipment

Capital equipment is set up in the MRI suite (*Figure 5*).

5. Device Description

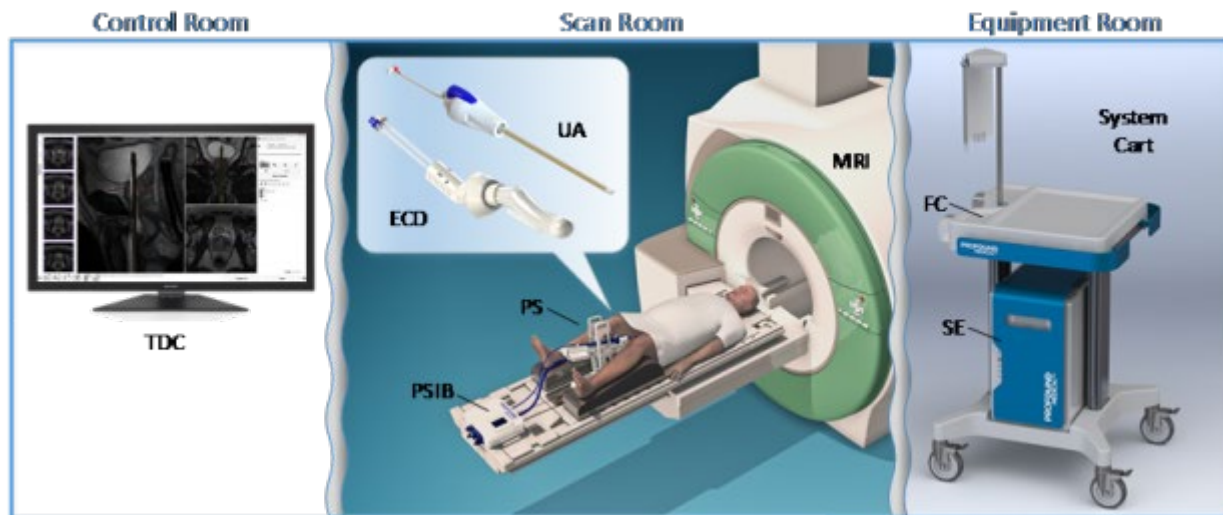

Figure 5: TULSA-PRO® System components

Capital equipment consists of:

- Treatment Delivery Console (TDC) – custom software and user interface
- System Cart (SC) – a transportable equipment cart consisting of:
 - System Electronics (SE) – power and control signals for the TULSA-PRO® System
 - Fluid circuit (FC) – a cooling fluid circulation system
- Positioning System (PS) – for device support and linear and rotational positioning
- PS Interface Box (PSIB) – motion control electronics with user interface

Other accessories and cables (not shown):

- Filter Box (FB) – a shielded connection enclosure for all signals passed into MRI suite
- Magnet Kit –patient base plate and leg supports with straps and clips (if required, some kits will include a coil holder)

Treatment Delivery Console (TDC) Software

The TDC software provides the main user interface for the TULSA-PRO® System. The software controls:

- setting up the patient treatment file
- transferring MR images from the MR scanner console
- precise positioning of the UA in the prostate
- treatment planning and definition of control boundary
- accurate delivery of ultrasound to the prostate with the aid of real-time temperature feedback from the MR scanner.

The software displays continuous information, such as intraprostatic temperatures and device parameters, during the treatment.

The TDC uses a feedback control algorithm to produce volumes of thermal coagulation that conform to predefined 3D prostate geometries by using temperature and spatial anatomical measurements to

5. Device Description

modulate device rotation rate, ultrasound power, and operational frequency. New temperature and spatial anatomical measurements are received from the MRI in real-time every 5 to 7 seconds.

The software is installed on a personal computer and a monitor, keyboard, and mouse are provided for display and interaction. The TDC is intended to be used at the MRI console with the operator seated. Since the user interface displays information essential for safe operation of the TULSA-PRO® System, the operator **must** stay by the display at all times during treatment delivery.



To ensure proper performance of the software, it is important that no other software runs on the TDC computer during treatment delivery. In particular, any anti-virus software scans should only run when the TDC computer is not being used for a treatment.



NOTE: On any TDC screen—except during Treatment Delivery—press F1 on your keyboard to open and review the TULSA-PRO® *Operator's Manual*.

System Cart (SC)

The System Cart is a transportable cart (*TULSA-PRO® System Cart*) that houses two main system components:

1. the Fluid Circuit hardware
2. the System Electronics.

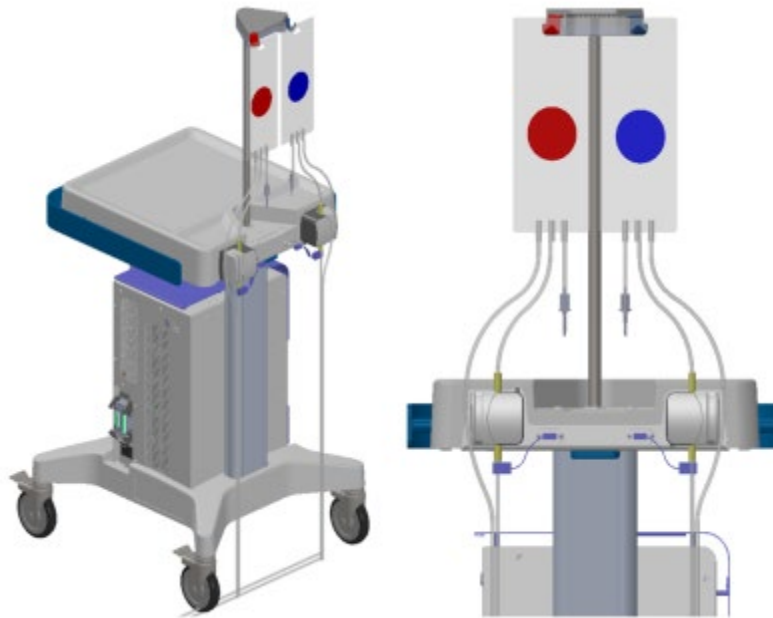

Figure 6: TULSA-PRO® System Cart

System Electronics (SE)

The System Electronics provide power and electrical signals to all components of the TULSA-PRO® System.

5. Device Description

- The SE interfaces with the Fluid Circuit hardware and powers and controls the pump motors, and reads the temperature, pressure, and weight sensors.
- The SE interfaces with the PSIB providing power and communications for the magnet-room electronics (Positioning System and UA) through a single cable to the RF filter box located on the penetration panel.
- The SE connects to the TDC through an Ethernet cable.

Fluid Circuit and Tube Sets

The Fluid Circuit pumps room-temperature cooling-fluid through the UA and Endo-rectal Cooling Device (ECD) during treatment. The Fluid Circuit tubing (not shown) connects to the UA and ECD using Luer fittings. The two circuits are colour-coded: red and white for UA, and blue and yellow for ECD.

The Fluid Circuit hardware (pumps and sensors) is re-usable capital equipment and is located on the System Cart within the MRI equipment or control room.

The fluid tubing passes into the MRI suite through a standard waveguide located in the wall of the MRI suite.

All Fluid Circuit tube sets are intended for single use. Tube sets part number (104010) for the UA circuit are delivered sterile (by ethylene oxide) and are indicated by a red label and red fittings. Tube sets Part number (112563) for the UA circuit are delivered non-sterile and are indicated by a red label and red fittings. Tube sets for the ECD circuit are non-sterile and are indicated by a blue label and blue fittings. The shelf life for all tube sets is five (5) years from the date of manufacture.

Positioning System (PS)

The Positioning System (*Figure 7*) is designed to mount on the patient base plate, which in turn is secured on the MRI patient table during treatment and fits between the legs of the patient. The PS supports the UA once it is inserted into the patient. The PS provides motor-controlled translation of the UA for positioning the ultrasound elements precisely in the prostate and creating a three-dimensional heating pattern.

You can make manual adjustments in the head-to-foot direction by squeezing the Forward and Backward adjustment release and guiding the PS into a new linear position. The Up and Down adjustment-lock controls both the height of the PS and the angle of the tilt. Lateral adjustment of the PS is achieved using the knobs located behind the Up/Down and angular adjustment lever.

The PS and its electrical signals are safe for use in the magnetic field environment. Control signals for the PS originate from the System Electronics outside the MR suite. Cables connecting the PS electronics to the PS itself are routed through an electrically grounded panel in the wall of the MRI suite (Filter Box). The PS electronics are housed in a sealed Positioning System Interface Box (PSIB).

5. Device Description

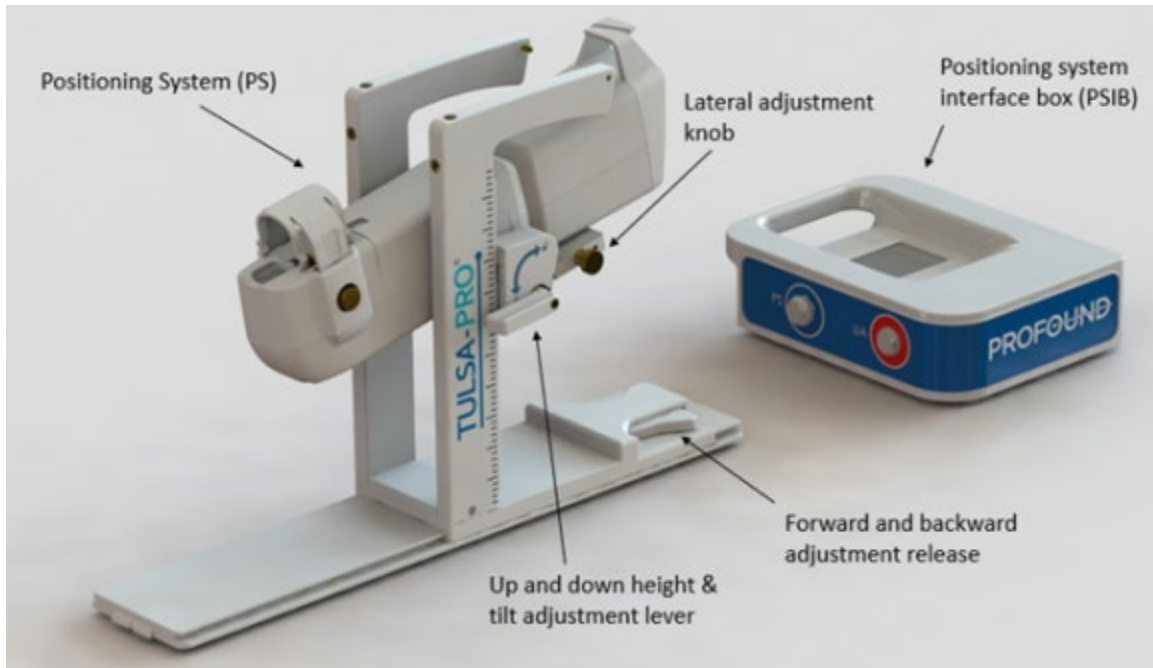

Figure 7: TULSA-PRO® PS and PSIB

Filter Box

The TULSA-PRO® System requires a Filter Box (*Figure 8*) for all RF, system power, control, and communication lines going into the magnet room. The Filter Box is mechanically attached to the RF enclosure wall (penetration panel) between the equipment room and the magnet room. A single mass-termination cable attaches to the Filter Box from both sides in order to pass signals into the magnet room.

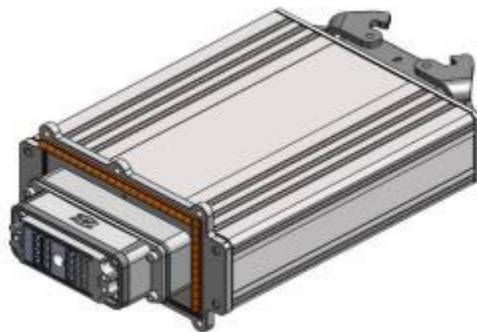

Figure 8: TULSA-PRO® Filter Box

5.b.ii Single-use Disposable Devices

The following single-use disposable devices are required for each treatment with the TULSA-PRO® System:

- Transurethral Ultrasound Applicator (UA) – provides transurethral delivery of ultrasound energy to the prostate

5. Device Description

- Endo-rectal Cooling Device (ECD) – a passive cooling device to protect rectal tissue
- Fluid Circuit Tube Sets (not shown) – channels cooling fluid to and from UA and ECD
- ECD Fluid Supplement – facilitates air bubble purging and renders the ECD MRI-opaque

The UA, ECD, and tube sets are single-use components and must be disposed of after treatment and not re-used (see TULSA-PRO® Operator's Manual). The equipment might be contaminated with body fluids and can cause infection in subsequent patients. Always use new components for each patient.

The UA and UA Fluid Circuit tubing (UA Tube sets part number 104010) are sterile and intended for single use only.



UA Tube sets part number 112563 are non-sterile and intended for single use only.

Never use devices that do not come from a sterile package.

Inspect all sterile packages before opening and discard any packages that appear damaged in any way that might compromise product sterility.

These single-use components must not be re-sterilized; Profound Medical has not tested the function or sterility of these components after multiple sterilization cycles.

Transurethral Ultrasound Applicator (UA)

The UA (*Figure 9*) houses a high-power, piezo-ceramic, ultrasound transducer that emits high intensity ultrasound energy into the prostate during treatment. The ultrasound beam is directional; a three-dimensional pattern of ultrasound energy and tissue heating is achieved through motor-controlled rotation of the UA during treatment. The ultrasound transducer itself is subdivided into a linear array of ten, planar, rectangular elements that are controlled independently to conform heating to targeted prostate boundaries.

The depth of coagulation is modulated through:

- The rotation speed of the UA
- individual control of power and frequency to each element.

Rotation rate, power, and frequency are automatically updated every five to seven seconds during treatment as temperature feedback information is acquired by the TDC software through the MR scanner. The ultrasound application treatment usually takes less than 90 minutes, but the treatment duration depends on the size of the prostate and volume of tissue being ablated.

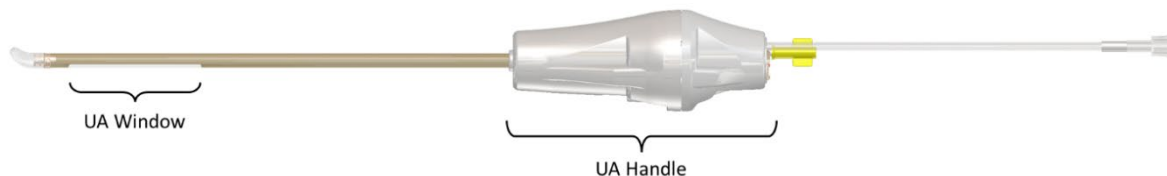

Figure 9: TULSA-PRO® Ultrasound Applicator

5. Device Description

Example

Figure 10 shows the ultrasound-beam temperature profile in tissue produced by a UA in the direction of heating. The highest temperatures are located near the UA. Maximum temperatures are maintained below 100°C to avoid tissue carbonization and boiling, which should be avoided during ultrasound therapy.

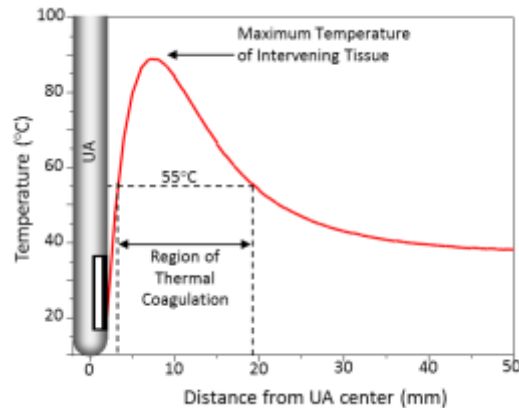

Figure 10: Sample UA temperature distribution along the heating direction

The shaft of the UA is rigid and similar in size and shape to other urological devices. There is a soft coude-style tip on the end of the shaft to aid with insertion. Also, to aid with insertion, the UA accepts a maximum 0.96 mm (0.038 in) guidewire. The rigid shaft and tip portion of the UA is rated IPx7 for ingress protection against the effects of temporary submersion in water. However, the plastic handle enclosure contains electronics and should **not** be submersed in water.

The UA connects to the Fluid Circuit with red and white Luer fittings. Water is circulated through the UA to remove heat from the ultrasound transducer and couple the generated ultrasound into the tissue.

The UA is provided sterile (by ethylene oxide) and intended for single use. Refer to the treatment kit label for the expiry date

Endorectal Cooling Device (ECD)

The ECD (*Figure 11*) is inserted into the patient's rectum and treated, or doped, water is circulated through the device to protect rectal tissue from thermal damage during ultrasound treatment delivery (see 'Treating, or doping, the ECD circuit' in the *TULSA-PRO® Operator's Manual*). The ECD is a rigid structure that will not deform in shape during the treatment. It connects to the Fluid Circuit with blue and yellow Luer fittings. With some versions of the ECD, lubricant can be applied to—or extracted from—the porous, anterior surface of the ECD using a syringe connected to the green and black Luer fittings. A balloon on the underside of the ECD is then inflated with saline to help with device positioning.

The ECD is provided non-sterile and intended for single use. See the ECD label for its shelf life.

5. Device Description

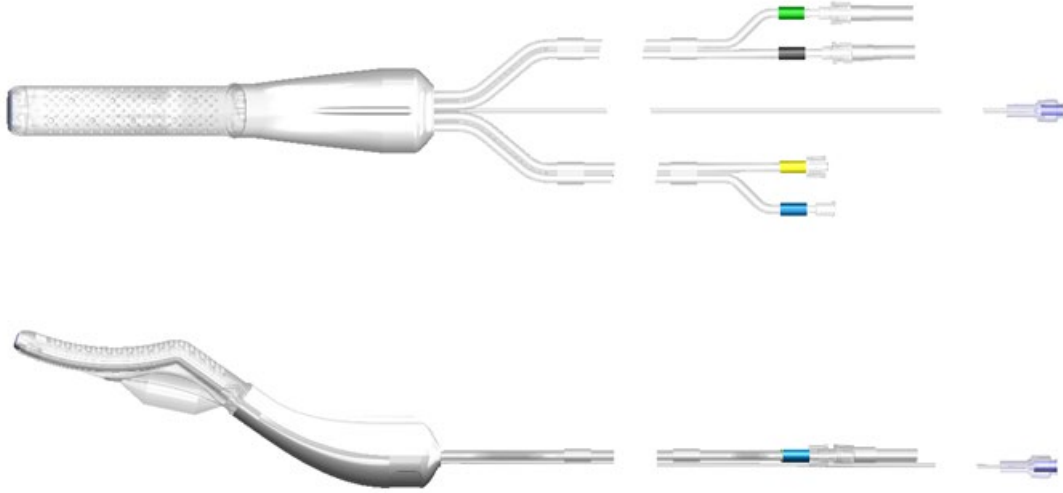

Figure 11: TULSA-PRO® Endo-rectal Cooling Device with lubricant tubes

Patient-Contacting Parts

The intended patient-contacting portion of each device is shown in *Figure 12* and *Figure 13*.

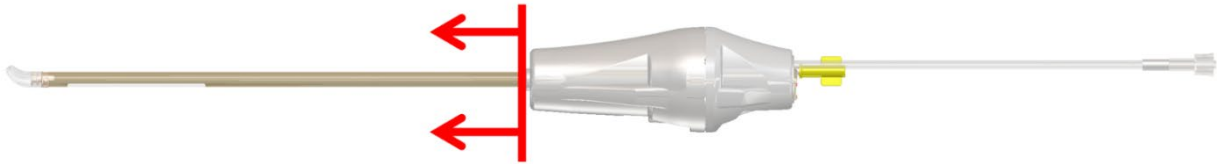

Figure 12: Patient-contacting region of the UA

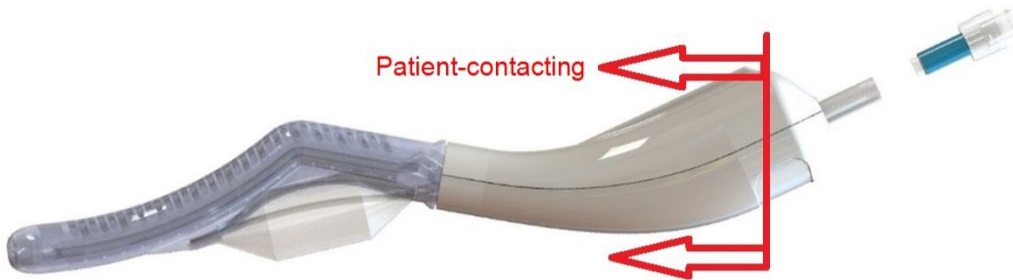

Figure 13: Patient-contacting region of the ECD

6. Warnings and Cautions

6.a Warnings

Warnings are potentially hazardous situation which, if not avoided, could cause death or serious injury. Here is a list of warnings for safe and effective operation of the TULSA-PRO® System.

WARNING LABEL	DESCRIPTION
Patient Safety	MR-guided transurethral ultrasound therapy using the TULSA-PRO® System has inherent risks of complications. The TULSA-PRO® System and components should only be used in accordance with the intended use, indications for use, and instructions for use. Failure to do so could affect patient safety, cause insufficient therapy, or both.
Patient Motion	Successful targeting and treatment of the prostate gland, and avoidance of thermal damage to surrounding anatomy, depends on accurate Magnetic Resonance (MR) images of the patient. Once treatment planning has begun, patient motion (voluntary or involuntary) is not tolerated by the treatment planning or delivery software. You must be vigilant to watch for patient motion and must stop treatment if you see any patient movement.
Damage to the External Sphincter	If the TULSA-PRO® Ultrasound Applicator (UA) is incorrectly placed or moves during treatment, the patient's external sphincter can overheat, causing temporary or chronic incontinence. Use MR images to check that the UA is correctly positioned and check MR images regularly during treatment delivery to ensure the UA has not moved. It is recommended that operators read the <i>TULSA-PRO® Operator's Manual</i> to avoid external sphincter damage.
Damage to the Rectum	<p>The Endo-rectal Cooling Device (ECD) must be correctly positioned in the patient's rectum (depth and orientation) to provide cooling to the rectal wall during treatment. Always use lubricant on the device and insert the ECD into the rectum only until resistance is felt. Rectal perforation requiring surgical intervention can occur if the ECD is inserted with too much force.</p> <p>The ECD must be completely free of air bubbles to avoid absorbing ultrasound energy. Use MR images to check that the ECD is correctly positioned and check MR images regularly during treatment delivery to ensure the ECD has not moved.</p>

The TULSA-PRO® System is designed to operate together with a Magnetic Resonance scanner. The patient, system operators, and health care personnel must be screened before entering the MR environment. All equipment entering the MR environment will be subject to strong magnetic fields and must be approved by Profound Medical before use.

All TULSA-PRO® System equipment is specifically identified as MR Safe, MR Conditional, or MR Unsafe for use in the MR environment. To learn a device or component's MR safety rating, check the labels on the component and its package (see *List of Symbols*). All health care personnel and system operators must be vigilant to ensure that only approved tools, medical supplies, and equipment are brought into the MR environment. Personal injury or equipment damage can occur if care is not taken.

CLASSIFICATION OF TULSA-PRO SYSTEM COMPONENTS



MR Unsafe



MR Unsafe



Strong Magnetic Fields

- Magnet Kit (pads and straps)
- Endorectal Cooling Device
- ECD Fluid Supplement
- System Electronics (SE)
- System Cart (SC)
- Treatment Delivery Console (TDC)
- Filter Box (FB)
- RF Cable (SE to FB)
- Computer Monitors
- TDC Cart (if using)



MR Conditional



Ultrasound Applicator, Fluid Tube-sets, Magnet Kit (base plate, leg supports), Positioning System (PS), Positioning System Interface Box (PSIB)

These components have been tested in 1.5T and 3T MRI systems. Follow the *TULSA-PRO Operator's Manual* for equipment setup and usage instructions.

UA Cable, PS Cable

Use only the cables that ship with your TULSA-PRO system. These cables have been tested and are compatible with your MRI system. Do not transfer these cables to a different MRI system, or unexpected surface heating could result. Follow the *TULSA-PRO Operator's Manual* for equipment setup and usage instructions.

RF Cable (FB to PSIB)

- Cable must be installed according to the Equipment Setup section in the Operator's Manual
- Cable must be attached and secured at both ends and must not be routed through the MRI bore.

If the cable is **not** attached at both ends, the connector could be pulled into the magnet and cause damage to the MRI. If the cable is routed through the MRI bore, unexpected heating and patient injury could occur.

The following conditions for safe use apply to the TULSA-PRO MR conditional components listed above:

- Static Magnetic Field Strength (B0): 1.5T and 3T (Refer to cable specific labeling for cable field strength)
- Type of Nuclei: 1H
- MR Scanner Type: Cylindrical Bore
- B0 Field Orientation: Horizontal
- Maximum Spatial Field Gradient: 4 T/m
- Max Gradient Slew Rate: 200 T/m/s
- RF Excitation: Circularly Polarized
- RF Transmit Coil Type: Integrated Body Transmit Coil
- RF Receive Coil Type: array coils placed anterior and posterior to the patient's lower abdomen
- Maximum Whole-Body SAR: 2 W/kg
- Patient Position: Patient supine, positioned as described in Operator's Manual
- Image Artifacts: Device may produce image artifact

6.b Cautions

Cautions are potentially hazardous situation, which, if not avoided, could cause minor or moderate injury. They are also used to alert against unsafe practices.

The following is a list of precautions for safe and effective operation of the TULSA-PRO® System.

6.b.i Equipment Setup

CAUTION

DESCRIPTION

6. Warnings and Cautions

Installation and Testing	The TULSA-PRO® System must be installed and tested before use by a representative of Profound Medical.
Equipment Storage Conditions	<p>Refer to <i>Operating and Storage Conditions</i> for acceptable temperature and humidity storage conditions for the TULSA-PRO equipment.</p> <p>Capital Equipment - You must report exclusions from these conditions to an authorized Profound Medical service representative. Equipment requires testing to confirm functionality.</p> <p>Disposable Devices - Devices exposed to extreme temperature excursions must not be used, due to unknown effect on device performance. Contact your local sales or clinical representative to replace these devices.</p>
Equipment Storage	The TULSA-PRO® System must be stored in a location with restricted access to avoid unauthorized modification of the system components or tampering with software.
IT Networks	<p>The TULSA-PRO® System is installed and validated on the IT network in the hospital or clinic organization. Personal health information is transferred through this network. Connection to a different IT network or changes to the IT network could cause previously unidentified risks to patients, operators, or third parties, including exposing personal health information to unauthorized users.</p> <p>Changes to the IT network include:</p> <ul style="list-style-type: none">• changes in network configuration• connection of additional items• disconnection of items• update of equipment• upgrade of equipment. <p>The hospital or clinic organization is responsible for identifying, analysing, evaluating, and controlling these risks.</p>
External Removable Devices	<p>USB ports found on the TDC computer are a source of potential cybersecurity threats. If tampering is evident or suspected, contact Profound Medical for technical support immediately.</p> <p>When connecting external storage media to the TDC computer, ensure that it does not contain viruses or malware, which could infect the TDC computer and/or networks it is connected to.</p> <p>USB storage devices must be formatted to FAT, FAT32 or NTFS. BitLocker-enabled devices are supported and recommended for transferring files that may contain patient-health information (treatment reports and treatment videos).</p>

6. Warnings and Cautions

The TULSA-PRO® System can malfunction if transmitting devices, such as mobile telephones or two-way radios including antennas, are used near the equipment. Devices must be no closer than 30 cm from any part of the system, including cables.

Do not install any other software on the TDC computer; this can cause the TULSA-PRO® System to malfunction or be exposed to malware.

You must quit all other applications and programs before starting the TULSA-PRO® software. Do not attempt to run other applications simultaneously or system function may be compromised.

Do not adjust or replace the operating system of the TDC computer or install any software updates. This could cause the TDC software to malfunction. Only service personnel authorized by Profound Medical should set up and configure the TULSA-PRO® software.

Do not run anti-virus scans on the TDC computer while running the TDC software because it can decrease performance.

The TULSA-PRO® TDC computer does not support joining an Active Directory. Group policy changes may result in unexpected system behavior.

Incompatible Equipment and Software Programs

Loss of Data

If the TULSA-PRO® System is switched off while the program is accessing the hard drive, data can be lost or corrupted. To prevent data loss or corruption, always exit the program before turning off the unit. IT professionals should back up data regularly and delete old data from the TDC computer.

External Electronic Interfaces

Do not plug in USB devices to the TDC computer that are not external storage devices.

Do not disconnect network cables during the operation of the TULSA-PRO® system, as it will likely result in a software alarm and unnecessary treatment delays.

6. Warnings and Cautions

<p>Power Requirements, Voltage and Cabling</p>	<p>The TULSA-PRO® System must be plugged into the appropriate voltage outlets:</p> <ul style="list-style-type: none">• System Electronics mains power: 100-240 Vac, 50/60 Hz, 1000W; use an appropriate outlet to support this power demand• Treatment Delivery Console (TDC) computer mains power: 100-240 Vac, 50/60 Hz, 300W <p>Use only the electrical power cables supplied with the TULSA-PRO® System. These cables are fitted with a hospital-approved, three-pole plug with a protective ground conductor.</p> <p>Never use an extension cable with the main electrical power cable. The length of the extended cable increases the resistance of the protective ground conductor beyond an acceptable level.</p> <p>Never use the System Electronics on the same outlet as another high-current drawing device (such as an air compressor); this can cause over-loading of the circuit.</p> <p>Always keep power cables, sockets, and plugs clean and dry.</p>
<p>Grounding System</p>	<p>Only connect the equipment to an AC power supply that has a protective ground conductor in accordance with IEC requirements or applicable local regulations. The grounding system in the treatment area should be checked regularly by a qualified engineer or hospital safety personnel.</p> <p>Never interrupt the protective ground conductor inside or outside the equipment, or disconnect the protective ground terminal, or you are likely to make the apparatus dangerous to operate. The ground conductor must be checked regularly.</p>
<p>Do Not Stack Equipment</p>	<p>TULSA-PRO® system components should not be used adjacent to or stacked with other equipment and if adjacent or stacked use is necessary, the system should be observed to verify normal operation in that configuration in which it will be used.</p>

6. Warnings and Cautions

The TULSA-PRO® System needs special precautions regarding EMC and must be installed and put into service according to the EMC information described in *Service and Maintenance*.

Only use the TULSA-PRO® System within a commercial or hospital MRI environment. The MRI environment should provide RF shielding effectiveness of minimum 80dB isolation from 2MHz to 128MHz.

Portable and mobile RF communications equipment can affect the TULSA-PRO® System.

Electromagnetic Compatibility (EMC)

The emissions characteristics of this equipment make it suitable for use in industrial areas and hospitals (CISPR 11 class A). If it is used in a residential environment (for which CISPR 11 class B is normally required) this equipment might not offer adequate protection to radio-frequency communication services. The user might need to take mitigation measures, such as relocating or re-orienting the equipment.

Certain common low frequency, RF emitters, such as RFID systems operate at 134.2kHz and 13.56 MHz that are commonly used in professional healthcare facilities for inventory control and other device recognition purposes. This is a potential source of EMI (electromagnetic interference). DO NOT USE such RFID equipment in the vicinity of the TULSA-PRO during clinical operation.

Lethal Voltages

The TULSA-PRO® equipment carries lethal voltages when connected to the electrical supply. Do not attempt to remove enclosure covers or attempt any repair or service activity, at risk of death or personal injury. Always contact Profound Medical for authorized maintenance or repair.

Replacing Fuses

The System Electronics power entry module contains two fuses that can be replaced by an operator. Use the correct model number of replacement fuse depending on the jurisdiction of use:

- North America: Two (2) 10A Fuses, 250VAC 5x20mm, Manufacturer Littelfuse, Part No. 0218010.HXP
- European Union – Two (2) 5A Fuses, 250VAC 5x20mm, Manufacturer Littelfuse, Part No. 0218005.HXP

Failure to use the correct fuse could cause an equipment fire or burn the operator.



Never replace fuses while using the equipment with a patient.



Potentially Explosive Environments

The TULSA-PRO® System is not designed for use in potentially explosive environments. Never operate it in the presence of flammable liquids or gases.

6. Warnings and Cautions

Emission Levels and Degree of Immunity	The use of accessories and cables, other than those stated in the instructions given in this manual and provided by Profound Medical, can cause increased emissions or decreased immunity of the TULSA-PRO® System.
Inspect Equipment Before Each Use	All components, cables, and accessories should be inspected for damage before each use. Contact a Profound Medical authorized service representative if you see damaged equipment.
Accessories, Transducers and Cables	Using accessories, transducers, and cables other than those specified, with the exception of transducers and cables sold by the manufacturer of the TULSA-PRO® System as replacement parts for internal components, can cause increased emissions and decreased immunity of the TULSA-PRO® System.
Coiling Electrical Cables	Do not coil electrical cables that are in the MR scanner room. RF heating of the cables can occur during MR imaging, resulting in a patient burn. Properly drape and pad the patient to ensure there is no direct patient contact with external equipment or cables.
Electrical Connections to MRI Suite	Use only the grounded Filter Box provided to route electrical cables into the MRI suite. Failure to use the TULSA-PRO® penetration-panel filter box can interfere with normal operation of the MRI system, which could cause corrupt MR images and inaccurate temperature measurements.
Keep Fans Clear	The System Electronics enclosure has openings on the front and rear sides for air intake and air exhaust. Do not block these openings or the electronics could receive insufficient air flow for cooling, which can cause components to overheat and fail.
Acceptable Ambient Temperature	<p>The fluid flowing through the UA keeps the urethra cool, which helps protect urethral tissue. The ECD cools the rectal wall, which protects the rectum from heat damage. The UA and ECD fluids flow from IV bags that hang on the System Cart.</p> <p>Check the 'Operating Environment' in the <i>Service and Maintenance</i> to learn the acceptable ambient temperatures that will reduce the risk of tissue damage. If fluid temperatures are higher or lower than the specified range, you will see an Information message on the TDC Console.</p>
Use Only Sterile Devices	The UA and UA Fluid Circuit tubing are sterile and intended for single use only. Never use devices that do not come from a sterile package. Inspect all sterile packages before opening and discard any packages that appear damaged in any way that could affect product sterility.
UA is Fragile	The UA is fragile and should be handled with extreme care. If dropped or handled roughly, internal components could be damaged in ways that are not obvious to an operator. Do not use a UA if you suspect any damage.

6. Warnings and Cautions

Use Only Sterile Cooling Fluid	<p>Use only the specified sterile water IV bags to fill the UA and ECD fluid circuit. Do not use saline IV bags; saline will interfere with the MR images used for temperature monitoring during treatment.</p>
ECD Fluid	<p>Good fluid flow in the ECD provides effective cooling of the rectal wall. Without continuous fluid flow, there is risk of unintended heating and thermal damage to the rectal wall, which may lead to unwanted medical intervention.</p> <p>To ensure proper fluid flow to the ECD, inject the ECD Fluid Supplement solution into the ECD sterile-water IV bag before filling the circuit (see 'Treating, or doping, the ECD circuit' in the <i>TULSA-PRO® Operator's Manual</i>). If you do not add the correct volume of solution, the MR signal from the ECD will cause imaging artifacts.</p> <p>Once MR imaging starts, check that the water in the ECD appears black on the MR image. Without the additive, the water appears very bright.</p> <p>There must be no air bubbles in the cooling device. Bubbles reduce the cooling capability, which might cause imaging artifacts and unintended heating where the ultrasound interacts with the air bubbles.</p>
	<p> Never put UA fluid into the ECD Circuit. ECD fluid is sterile water with manganese chloride added to minimize flow artifacts on MR thermometry imaging (and surfactants added to minimize bubble formation). Since the UA fluid (sterile water with no additives) does not contain manganese chloride, its use in the ECD may alter the rectal imaging characteristics (producing artifacts), which could impact rectal safety.</p>
Do Not Drink Fluid	<p>The ECD Fluid Supplement solution provided for the ECD fluid circuit is not safe for drinking. Gastro-intestinal irritation can result if this fluid is ingested.</p>
UA Fluid	<p>It is important to maintain good fluid flow in the Ultrasound Applicator (UA) in order to:</p> <ol style="list-style-type: none">1. Cool the surrounding tissue of the urethra, which reduces post-treatment genitourinary complications.2. Cool the active ultrasound transducer elements within the applicator. Improper cooling can damage transducers and they would stop sending out power3. Ensure that there is an uninterrupted, air-free path for ultrasound to travel from the transducer into the prostate.
	<p> Never put ECD fluid into the Ultrasound Applicator. See 'Fluid preparation' in the <i>TULSA-PRO® Operator's Manual</i> for more about the risk.</p>

6. Warnings and Cautions

Fluid Tube Setup	<p>It is important to correctly set up and connect all fluid tube sets to ensure there is good fluid flow through the UA and ECD during treatment. If fluid flow is restricted, there can be overheating of the UA or ECD, which can cause thermal damage to tissue and anatomical structures beyond the prostate boundary or to the rectal wall, respectively.</p> <p>The System Cart will monitor the fluid pressure and volume, and a high pressure or low volume alarm might indicate interrupted fluid flow in the UA or ECD. For instructions on proper fluid tube setup, see 'System cart' in the <i>TULSA-PRO® Operator's Manual</i>.</p>
No bubbles in UA and ECD	<p>Ensure that no bubbles are inside the Ultrasound Applicator (UA) and the Endo-rectal Cooling Device (ECD). Always check for bubbles after purging the devices.</p> <p>Bubbles in the ECD can prevent adequate cooling of the rectal tissue and affect the accuracy of the thermometry in the surrounding tissue. Bubbles in the UA can deflect the ultrasound to heat tissue outside of the intended treatment volume or prevent adequate heating of the intended treatment volume.</p>
Air in Fluid Circuit Lines	<p>Take care not to introduce air bubbles in the fluid lines after they are purged during system setup. Any air bubbles that remain in the lines could interfere with ultrasound transmission into tissue or MR imaging of the ECD, which in turn can lead to inaccurate treatment or tissue damage.</p> <p>Before use, check that all air bubbles have been removed from the UA and ECD. For instructions on filling devices with water and removing air from the fluid tubing, see 'Fluid Preparation' and 'UA and ECD Preparation' in the <i>TULSA-PRO® Operator's Manual</i>.</p>
Positioning System Setup	<p>The Positioning System (PS) must be set up in accordance with instructions in the <i>TULSA-PRO® Operator's Manual</i>. The PS must be inserted and locked to a customized patient-support base plate, which is firmly attached to the MRI table. The operator must check that the manual axes are in good working order. Failure to properly set up the PS axes can cause failure of UA translation within the prostate during device positioning and possible patient injury.</p>
Positioning System Automated Axes	<p>UA motion is controlled by automated linear and rotary axes on the Positioning System (PS). Never move these axes manually—use only the motion commands in the software. Manually moving these axes can damage the motors inside the PS.</p>
Handling Portable Components	<p>Take care when handling portable equipment, such as the Positioning System (PS). Damage to equipment can occur if portable equipment is dropped from the height of the MRI patient table.</p>

6. Warnings and Cautions

Motion of MRI Table	<p>Ensure that the Positioning System (PS) will not collide with the MRI bore when the patient table is advanced for scanning.</p> <p>Ensure that all cables, tubes, and drapes will not interfere with the motion of the MRI table.</p> <p>Ensure that the patient or operators will not be pinched or trapped between TULSA-PRO equipment and the moving MRI table.</p> <p>Ensure that the Positioning System (PS) will not collide with the MRI bore.</p>
Verifying Equipment Setup	<p>Double-check the integrity of all mechanical fasteners and electrical connectors before operating the TULSA-PRO® System. Faulty connections can cause unpredictable ultrasound delivery during treatment.</p>
Liquid Ingress	<p>The TULSA-PRO® System Electronics (SE) and the Treatment Delivery Console (TDC) are not rated for water exposure. Do not expose the SE or TDC to water or it can cause permanent damage.</p> <p>The System Cart, Positioning System, and Positioning System Interface Box (PSIB) have been tested against and can withstand vertical drops of fluid.</p> <p>Some MRI coils can be permanently damaged when exposed to water:</p> <ul style="list-style-type: none"> • The TULSA-PRO® coil holder for Philips Achieva and Ingenuity do not protect the MRI coil from liquid ingress; protect the coil holders using absorbing pads or drapes. • TULSA-PRO® coil holders for Siemens Skyra, Siemens Prisma, and Philips Ingenia MRIs do protect the coils from any drops of fluid. • TULSA-PRO® configurations that do not use coil holders and use the MRI spine array will not protect the MRI coil from liquid ingress; protect the spine array using absorbing pads or drapes. <p> Always follow the specific IP rating on each piece of equipment for specific water ingress precautions.</p>
Overturning the System Cart	<p>Do not tilt the TULSA-PRO® System Cart from its upright position. Tilting could cause the cart to overturn and cause injury to the operator and damage to the equipment.</p>
Contact with TULSA-PRO Equipment	<p>The user must use medical gloves when working with, handling, or positioning the TULSA-PRO equipment</p>

6.b.ii Therapy Related – Patient Preparation

CAUTION

DESCRIPTION

6. Warnings and Cautions

Direct Supervision	The use of the TULSA-PRO® System must be prescribed and administered under the direct supervision of a qualified, trained physician and after appropriate medical evaluation of the patient.
Patient MR Screening	Before treatment, the MR technologist must screen the patient for MRI safety, including the MR screening patient questionnaire. This will ensure that the patient is cleared for undergoing an MRI scan and has no medical conditions or implanted medical devices that are contra-indicated for MRI.
Patient Positioning	Take care when positioning the patient on the MRI bed to avoid injury to the patient or equipment damage. To avoid skin burns from electrical currents, do not create any skin-to-skin or skin-to-bore contact when positioning the patient
Coil Positioning	Ensure the MRI coils are positioned so there is adequate signal coverage of the prostate and desired imaging field of view. Ensure the patient is positioned on the recommended area of the coil pad and the anterior MRI coil is placed on top of the patient's pelvis and prostate. Upon initial MR imaging (for example, Localizer), check that there is adequate signal coverage of the prostate and desired imaging field of view; if needed, reposition the anterior MRI coil or patient. Attempting to perform a TULSA treatment with inadequate image quality can result in inaccurate temperature measurements and heating of undesired tissue.
Patient Contact with the TULSA-PRO System	The only portions of the system which are intended for patient contact are the UA and the ECD (see <i>Single-use Disposable Devices</i>) All other components are not intended for direct patient contact. Gowns, stockings, sheets, absorbent pads or other patient safe materials should be placed between the patient and the device.
Improper UA Insertion	The UA must be inserted by a trained urologist. Always use a urethral guidewire for inserting the UA, sterile lubricant on the device, and be careful when inserting the UA into the patient's urethra. Perforation and subsequent infection of the urethra can occur if the UA is not placed correctly. To avoid damaging the UA, it must be inserted with the window facing the patient's posterior.
UA Insertion: Poor Coupling	To avoid accidental undertreatment of the prostate tissue due to poor coupling between the UA and prostate, fill the patient's urethra with coupling gel before inserting the UA.

6. Warnings and Cautions

The Ultrasound Applicator (UA) is rigid. The urethra is lined with several thin tissue layers. It is possible to miss the urethral opening and push the UA into the wrong passage between layers, causing patient injury.

Possible incorrect insertion issues include:

UA Insertion: Urethral Damage

- pushing the UA too far and into the bladder, causing damage
- not inserting the UA far enough and rotating the tip within the prostate
- pushing the UA tip downwards too much during initial insertion, damaging the urethra, penile bulb, penis, or external urinary sphincter before entering the prostate
- locking the UA in a position that applies too much force on the pubic symphysis.

Be careful when inserting the UA. Consider using an MR-compatible guidewire to help avoid urethral injury.

Patient Restraint	After the patient is positioned on the MRI bed, restrain the patient's lower torso using a strap to restrict motion during the treatment. Patient motion can cause inaccurate temperature measurements and an inability to monitor heating in the prostate.
Patient Draping or Padding	To avoid electrical shock being passed from components to the patient, place absorbent pads or sheets under the patient to absorb any minor leaks, such as urine. Make sure there is no direct contact between the patient and any external equipment, such as the Positioning System (PS), cables, the bore of the magnet, and MR imaging coils. Sheets, absorbent pads, or other suitable materials should be placed between the patient skin and the devices.
Gradient Field Hazards	During scanning, gradients produce rapidly changing magnetic fields that can produce peripheral nerve stimulation (PNS) or a tingling sensation in some patients. Ensure that the patient's hands are not clasped or touching, and that feet are not crossed during scanning, which could form a conductive loop.
Ear Protection	You must give the patient ear protection before starting scans to help avoid hearing impairment.

6. Warnings and Cautions

Thermal Stress to Patient

The patient might experience warming when exposed to radio-frequency electromagnetic fields generated during the MR scan. The MR scanner has an RF power monitor and specific absorption rate (SAR) limitations to help prevent excessive RF exposure to the patient. SAR values are calculated based on the patient's weight.

To minimize the possibility of harm, when registering patients for an imaging exam enter their correct weight in the MRI computer software to set operating limits and prevent excessive RF exposure during treatment.

Damaged ECD

The ECD cooling surface can be easily damaged. Be careful when handling the ECD and do not drop it. Never use an ECD that you suspect is damaged. Any cracks or leaks in the ECD could expose the patient's rectal tissue to the ECD Fluid Supplement, which can cause tissue irritation.

Safe Limits for ECD Balloon

When first inflating the ECD balloon, you can safely fill it with between 5-20ml of fluid, followed by small increases with imaging confirmation. The maximum safe limit of ECD balloon inflation is 30ml. For instructions about filling the ECD balloon, see 'Inserting the ECD' in the *TULSA-PRO® Operator's Manual*.

6. Warnings and Cautions

6.b.iii Therapy Related – Treatment Planning



It is the responsibility of the treating physician to convey to the patient the relevant potential risks about treatment planning and treatment delivery.

When planning for TULSA treatment, the operating physician must balance the aggressiveness of treatment with the desire to spare surrounding anatomy from thermal damage. Structures of concern are:

- o the rectal wall
- o neurovascular bundles
- o external sphincter
- o internal sphincter
- o pelvic floor muscles.

Physicians should be able to identify these structures on MR planning images and follow the *TULSA-PRO® Operator's Manual*.

CAUTION	DESCRIPTION
Administer Anti-Spasmodic Drug	To eliminate involuntary peristalsis in the patient's rectum, administer a specified dosage of anti-spasmodic drug to the patient before starting treatment planning and again before treatment. Failure to do so can cause motion in the patient anatomy and therefore inaccurate planning or treatment images.
Danger of Ultrasound Power	Only emit ultrasound power when the UA is correctly positioned within the patient's body; otherwise, there could be injury to the patient or operator.
Verify Correct Treatment Planning Images	Always verify the correct image series is selected for treatment planning. During Detailed Planning in TDC software, always select the most recently acquired AX T2 MR image series for treatment planning. If the patient or any equipment has moved, and the most recent image is not loaded, the treatment plan might not reflect the most current anatomy, and ultrasound could be delivered to unintended tissue.
Verify UA Placement	Always verify the position of the UA transducer elements within the prostate using MR images through the UA before starting treatment planning. If necessary, adjust the position of the UA to ensure that the ultrasound will not be directed at the external sphincter.
Verify ECD Placement	Before treatment planning, always verify the position of the ECD in relation to the prostate using MR images.

6. Warnings and Cautions

Maximum Prostate Radius/Length	The TULSA-PRO® System is not designed to thermally treat regions of the prostate that extend farther than 30mm in any radial direction from the UA center or beyond 50mm in length. Partial gland treatments are possible within these limitations.
Drawing of Thermal Treatment Boundary	It is important that physicians understand and follow the <i>TULSA-PRO® Operator's Manual</i> , and only target tissue within the prostate. Reliable temperature measurements cannot be achieved outside of the prostate. Unpredictable thermal damage could result if the operator tries to target tissue outside of the prostate where temperature measurements are not accurate.
Eliminate air bubbles around UA and ECD	During treatment planning, check the MR images to ensure there are no bubbles in the urethra around the Ultrasound Applicator (UA) and in the rectum around the Endo-rectal Cooling Device (ECD). Bubbles in the rectum can prevent adequate cooling of the rectal tissue by the ECD and affect the accuracy of the thermometry in the surrounding tissue. Bubbles in the path of the ultrasound can cause tissue heating around the bubble and deflect ultrasound to heat tissue outside of the intended treatment volume.

6.b.iv Therapy Related – Treatment Delivery

CAUTION	DESCRIPTION
Treatment Supervision	A physician must always remain at the operator console and supervise the treatment.

6. Warnings and Cautions

CAUTION	DESCRIPTION
Continuous Monitoring of Treatment Delivery	<p>The system operator must monitor the user interface continuously during treatment delivery to identify:</p> <ul style="list-style-type: none"> • movement of the patient during treatment delivery; at any sign of movement, stop treatment • air bubbles in fluid lines that can become lodged in the UA or ECD; at any sign of air bubbles, stop treatment • software warnings related to degradation of image quality, which can affect temperature accuracy • software warnings related to unexpected fluid circuit temperature or pressure • difficulties in achieving enough ultrasound power • misalignment of the ultrasound beam relative to treatment angular position • software warnings related to other equipment malfunctions. <p>Failure to monitor and detect these conditions could result in heat delivery and thermal damage to unintended tissue.</p>
Boiling of Prostate Tissue	<p>To avoid the risk of boiling prostate tissue and subsequent unpredictable ultrasound absorption in boiled tissue, monitor the temperatures within the control boundary using real-time MR images during treatment delivery. Ultrasound power to the individual elements is shut down if tissue temperature within the target volume in the direction of ultrasound propagation reaches or exceeds 86°C. You will see a warning on the TDC if tissue temperature exceeds 100°C.</p>
Overheating of the UA	<p>If the cooling-fluid circulation is restricted, the transducer elements in the UA can overheat, which can damage the transducer and potentially under-treat the target volume. The pressure of cooling water in the UA line is monitored during treatment. You will see a warning in the indicator section of the TDC if pressure in the UA fluid line becomes unexpectedly too high or too low. If appropriate, the TDC will also interrupt or pause treatment delivery, or prevent treatment from starting, until the UA temperature drops to safe temperatures.</p>
Heating of pelvic floor muscles	<p>Due to variations in patient-specific tissue properties, the rate of heating at the control boundary can in some cases be lower than in the surrounding pelvic floor muscles (levator and obturator). Incidental heating of small portions of the pelvic floor muscles has not resulted in any serious complications and is part of the accepted benefit/risk profile. The physician monitors heating in real-time and can manually pause heating or adjust the treatment plan if required.</p>

6.b.v Therapy Related – Post Treatment



It is the responsibility of the treating physician to convey to the patient the relevant potential risks about post-treatment care.

CAUTION	DESCRIPTION
Never Reuse the UA, ECD, and Fluid Tubing	The TULSA-PRO® System UA, ECD, and tube sets should only be used once and disposed of after treatment, according to the disposal instructions in the <i>TULSA-PRO Operator’s Manual</i> . The UA and UA tube set are provided sterile and should not be re-sterilized. Re-sterilization and reuse can cause an unsafe treatment or cross-contamination between patients.
Disconnecting TULSA-PRO® Components and Cables	Take care when disconnecting cables and components of the TULSA-PRO® System. Extreme force on cables or components can damage equipment. Do not pull AC power cords with extreme force or from a distance greater than 30 cm. If you need to disconnect the System Electronics mains power cord, it is a latching connector and you must squeeze the two tabs together to remove the cord properly.
Care of Accessories	To prevent permanent damage to TULSA-PRO® System accessories, store, handle, and clean them according to the instructions in this manual and never expose them to temperatures over 50°C during operation.
Improper Cleaning	<p>Insufficient cleaning or use of cleaning methods or agents other than those described in the cleaning instructions can damage equipment or irritate skin for parts in contact with the patient or operator. Follow the instructions in the corresponding <i>TULSA-PRO Operator’s Manual</i> when cleaning reusable components of the TULSA-PRO® System.</p> <p>When cleaning, always use gloves and other personal protective equipment that meet the safety precautions recommended by the manufacturer of the cleaning agents.</p>
Using Supra-pubic Drainage	Always use supra-pubic drainage during and after treatment. Accumulation of urine in the bladder during treatment can cause prostate motion.

6. Warnings and Cautions

Routine Post-Operative Care	<p>It is recommended that a prophylactic antibiotic be administered in accordance with the clinical routines of the department.</p> <p>Also, for the first week after treatment with the TULSA-PRO® System, the patient should avoid excessive physical exertion.</p>
Catheterization Period	<p>It is recommended that patients remain catheterized for 1 to 4 weeks. Patients often experience urgency during the first period after treatment. This will reduce gradually, although it is normal for the feeling to persist for up to a month.</p>
Removing the Catheter	<p>You can remove the catheter after a successful voiding trial and at the discretion of the prescribing physician. After removing the catheter, there is still a risk of urine obstruction, retention, or stricture. It is therefore important to tell the patient to seek emergency medical attention if urine retention occurs.</p>
Tissue Sloughing	<p>During the first few months after treatment, it is normal for small pieces of dead tissue or small amounts of blood to be discharged with the urine. This is likely due to the destruction of the prostatic urethra during treatment.</p>
Safety and Effectiveness of Repeat Treatment	<p>The clinical safety and effectiveness of repeat Tulsa-Pro treatments or other salvage procedures and therapies in cases of inadequate treatment or recurrent disease has not been assessed.</p>

7. Operating Instructions



Depending on your MRI scanner model, please refer to the corresponding TULSA-PRO® Operator's Manual to proceed.

Electronic copies of manuals are available at www.profoundmedical.com/manuals. Additional paper copies of manuals can be ordered through your Profound Medical sales or service representative.

8. Operating and Storage Conditions

8.a System Operating Parameters

Temperature: 15°C to 30°C

Humidity: 5% to 95% non-condensing

8.b System Storage and Transport Conditions for Disposables (UA, ECD, Tube-Sets, and ECD Fluid Supplement)

Temperature: -25 °C to +50 °C

Humidity: 5% to 95% non-condensing

8.c System Storage and Transport Conditions (excluding UA, ECD, and Tube-Sets)

Temperature: -40 °C to +70 °C

Humidity: 5% to 95% non-condensing

8.d Power Requirements

8.d.i System Electronics

Mains Power: 100-240 Vac, 50/60 Hz, 1000W

Connection: Detachable power supply cord

Fuses: 250 VAC 5x20 mm, current rating depends on country of use

North America – Two **10A Fuse**, Manufacturer Littelfuse, Part No. 0218010.HXP

European Union – Two **5A Fuse**, Manufacturer Littelfuse, Part No. 0218005.HXP

**Fuses are replaceable by the operator. See instructions below.*



WARNING: Never replace fuses while using the equipment with a patient.

8.d.ii Treatment Delivery Console (TDC) Computer

Mains Power: 100-240Vac, 50/60Hz, 300W

Connection: Detachable power supply cord

8.e Electronic Interfaces

The TULSA-PRO® system contains Ethernet and USB ports. There are no wireless device requirements for the operation of the system (WLAN, Bluetooth, etc.).

8.e.i System Electronics

Ethernet Port: Set up and configured by Profound Medical authorized service personnel. Used exclusively to communicate with the Treatment Delivery Console (TDC) computer.

8.e.ii Treatment Delivery Console (TDC) Computer

USB Ports: Used to transfer data from the TDC computer to an external storage device. Intended to be used by Profound Medical authorized service personnel and by users who wish to transfer data such as treatment reports and videos.

SE Ethernet Port: Set up and configured by Profound Medical authorized service personnel. Used exclusively for communication with the System Electronics and Positioning System Interface Box via standard TCP/IP protocol. The TDC Software controls and monitors both devices through this port.

MRI Ethernet Port: Set up and configured by Profound Medical authorized service personnel. Used for communication with the MRI computer software via standard TCP/IP protocol. The Treatment Delivery Console (TDC) Software receives real-time thermometry images from the MRI software, synchronizes its internal system clock and prescribes position and orientation of thermometry scans through this Ethernet port. Note that the TDC software does not start or stop MRI scans. Scans must be started and stopped via the MRI computer software.

Each MRI vendor provides an Application Programming Interface (API) with proprietary protocols that allow the TDC software to perform the operations mentioned above. The following are APIs supported by TULSA-PRO®.

- Siemens Therapy Pack
- Siemens Access-i
- Philips XTC
- GE ExSI/ILT

In addition, the TDC software uses this Ethernet port to receive planning DICOM images from the MR host using the network communication protocol established by the DICOM standard.

8.e.iii Ethernet Network Integrity, Performance and Functional Requirements

TULSA-PRO® requires at least a Fast Ethernet (100BASE-T) network to communicate with the MRI. TULSA-PRO® employs software mechanisms to ensure that the communication with the MRI and with the TULSA-PRO® internal components is reliable and that the loss of communication does not cause harm to patients and users. Furthermore, the TCP/IP protocol inherently provides TULSA-PRO® with data integrity when data is transmitted within its components and to and from the MRI computer.

Profound Medical authorized service personnel are responsible for ensuring that the TULSA-PRO® system is fully operating during installation, including its electronic interfaces.

8. Operating and Storage Conditions

Depending on the MRI vendor API, the commercial or hospital environment's IT department will be required to assign a static IP address to the TDC computer. This IP address will be required to be on the same subnet of the MRI computer so that a client/server TCP/IP connection can be established between the computers.

At the beginning of each patient treatment, the TDC software ensures that the networks are operating properly. Refer to the corresponding TULSA-PRO® Operator's Manual for more information.

During treatment planning and treatment delivery, TULSA-PRO monitors the state of the networks. Unreliability or malfunction of the networks (physical network, API, etc.) result in software alarms which indicate to the user what occurred. Refer to the corresponding TULSA-PRO® Operator's Manual for more information about specific alarms and troubleshooting.

8.e.iv Data Exchange

TULSA-PRO® receives DICOM images from the MRI computer. All information present in the DICOM images is transmitted to the TDC computer when the user pushes the images to the configured TULSA-PRO® DICOM node. This may include, for example:

- Patient name, sex, and age
- Patient ID
- Institution name and address, physician name
- Patient images as they were acquired by the MRI

MRI systems retrieve this information from the patient registration on the MRI computer.

The MRI vendor APIs also transmit images to TULSA-PRO® when real-time thermometry images are acquired. The same information present in the DICOM images that are transmitted via the DICOM node is present in the thermometry images.

8.e.v Time Synchronization

TULSA-PRO® requires that its internal time is synchronized with the MRI computer's when treatments are performed. Whenever possible, this is done automatically by the TDC software when the network connection is established with the MRI vendor API. However, the following APIs do not support time synchronization:

- Siemens Therapy Pack
- GE ExSI/ILT

When TULSA-PRO® is used with these APIs, time synchronization must be done manually. Refer to the corresponding *TULSA-PRO® Operator's Manual* for more information.

8.e.vi IT Personnel Training or Qualifications

TULSA-PRO® Education Program includes information about the TULSA-PRO® device training, which includes equipment setup. There is no special training or qualifications required for IT Personnel for the TULSA-PRO® set up.

9. Service and Maintenance

9.a Cleaning

Refer to the corresponding *TULSA-PRO® Operator's Manual* for detailed cleaning and disinfection instructions. Cleaning should be performed after each patient use.

9.b Calibration and Maintenance

All maintenance, except System Electronics fuse replacement, must be conducted by Profound Medical authorized service personnel. Do not attempt to open the covers of any electrical enclosures or you might damage equipment, which can cause unintended behaviour and performance of the system.

9.b.i Fuse Replacement

The System Electronics power entry module, located on the lower rear side of the enclosure, contains two fuses that an operator might need to replace.



Never replace fuses while using the equipment with a patient.

It is important to use the correct fuse part number, depending on the country of use:

- North America: 5x20 mm, 250V, **10A**, Littelfuse P/N 0218010.HXP (PMI P/N 104796)
- Europe: 5x20 mm, 250V, **5A**, Littelfuse P/N 0218005.HXP (PMI P/N 104797)

To replace a fuse:

1. Turn off the power to the System Electronics (SE).
2. Remove the SE power cord.
3. The fuse drawer is located at the middle of the power entry module. Using a small flat screwdriver, remove the fuse drawer from the power entry module.
4. Remove the two broken fuses from the fuse drawer and replace with two new fuses, noting the correct part number above.
5. Insert the fuse drawer back into the power entry module with the notch on the right side (*Figure 14*).



Figure 14: Fuse drawer placement

9.c System Life and Ongoing Maintenance

The TULSA-PRO® System capital equipment (see *System Components*) has a declared lifetime of 10 years from the point of customer acceptance. It is expected in normal use that the system will perform approximately 250 treatments per year. This device lifetime assumes routine servicing including software upgrades and the replacement of parts at the end of their normal life expectancy. Basic safety and essential performance with regard to electromagnetic disturbances is not expected to degrade over the expected service life of the equipment.

Once a year (or after about 250 treatments), an authorized Profound Medical service representative will inspect your entire TULSA-PRO® PAD-105 system as part of an annual preventive maintenance check. If at any time you think you need software upgrades, equipment calibration, or a performance check for the Fluid Circuit hardware, the Positioning System, or the System Electronics, please contact an authorized Profound Medical service representative.

When all equipment has reached the end of its expected service life, return it to Profound Medical for disposal. This includes capital equipment and unused single-use accessories that are past their expiry date.

9.d Anti-virus Scanning on TDC Computer

Only perform anti-virus scans using software validated by Profound Medical and only when the computer is **not** being used for treatment.

9.e Service and Replacement Parts



Never service the TULSA-PRO® System in any way while in use with a patient.

9. Service and Maintenance

Service or replacement parts are only available through Profound Medical and service should only be performed by service representatives authorized by Profound Medical. For inquiries, contact:

Profound Medical Inc.

2400 Skymark Avenue, Unit 6

Mississauga, ON, L4W 5K5

Telephone: + 1 647 476 1350

Fax: +1 647 847 3739

Email: techsupport@profoundmedical.com

www.profoundmedical.com

Appendix A. MRI Sequences

SCAN NAME	PROCEDURES	TDC STEP
Localizer	After inserting the UA and ECD, take an image of the patient to check the initial gross positioning of devices.	Device Insertion
SAG T2	Perform precise positioning of the UA using TULSA-PRO® software tools and image guidance. You must acquire a new set of images after each adjustment of the UA to verify its position.	Alignment and Coarse Planning
SAG SWI	Susceptibility weighted imaging (SWI) scan to detect calcifications. With the UA in the correct position, acquire oblique-axial, high-resolution images of the prostate.	Coarse Planning
AX T2 AX THERM	Coronal and sagittal views of the prostate are provided, using the most recent SAG T2 image set acquired during Device Positioning . Acquire a test AX THERM scan to construct the TUV and guide you in Treatment Planning .	Detailed Planning
AX DWI	Diffusion weighted imaging (DWI) scan for contouring the prostate. Import either the ADC or high b-value reconstructions.	Detailed Planning
AX THERM	With the treatment plan complete, the TULSA-PRO® treatment is delivered under real-time MRI thermometry feedback control. The AX THERM sequence is acquired in a continuous loop until you stop the treatment.	Delivery
AX T1	A contrast-enhanced MRI scan is acquired without (AX T1 pre) and with (AX T1 post) intravenous administration of a low molecular weight gadolinium-based contrast agent (such as Omniscan or Magnevist).	Post-Treatment

Appendix B. Specification Sheet

SYSTEM CART

- System Electronics with 10 RF amplifiers, fluid pumps, and sensors
- Mains Power: 100-240 Vac, 50/60 Hz, 1000 W

Ingress protection Rated IPX1 for ingress protection against only dripping water.

ULTRASOUND APPLICATOR

Profound Medical proprietary design trans-urethral single use sterile device

Construction Rigid tube with soft coudé tip, diameter 7.5 mm (22.5 Fr), 255 mm maximum insertion length, passage for guide wire

Ultrasound Transducer Linear array of 10 planar rectangular ultrasound transducer elements with individually controlled frequency and power

Ultrasound Frequency* Low Frequency Range: 4.1 to 4.5 MHz High Frequency Range: 13.0 to 14.4 MHz

Acoustic Power per Element Low Frequency Range: 4 W max High Frequency Range: 2 W max

Heating Method Rotation of high intensity directional planar (not focused) ultrasound produces controlled heating of swept volume

Treatable Volume Max Length: 5 cm along urethra Max Radius: 3 cm from urethra

Precision of ultrasonic power measurements +/- 30% or better

Ingress protection The rigid shaft and tip portion of the UA is rated IPX7 for ingress protection against the effects of temporary submersion in water.

* Some configurations activate only low frequency.

ENDORECTAL COOLING DEVICE

Non-sterile device for protection of rectal tissue during ultrasound ablation.

Ingress protection Rated IPX7 for ingress protection against the effects of temporary submersion in water.

POSITIONING SYSTEM

2-axis controlled and 3-axis manual adjustment

Rotation (Controlled) Max Speed: 120°/min Range: 2.5 rotations

Linear (Controlled) Max Speed: 40 mm/min Range: 78 mm

Y-axis (Manual)	Vertical linear with range: 20 mm to 211 mm
Z-axis (Manual)	Horizontal linear along axis of bore with range: 240 mm
Tilt (Manual)	Rotation about X axis -3° to +30°
Accuracy of Positioning System	<ul style="list-style-type: none"> ▪ Linear axis: +/- 0.7 mm or better ▪ Rotation axis: +/- 0.5 deg or better
Ingress protection	Rated IPX1 for ingress protection against dripping water.

POSITIONING SYSTEM INTERFACE BOX (PSIB)

Ingress protection	Rated IPX1 for ingress protection against dripping water.
---------------------------	---

TEMPERATURE CONTROL

Real-time MRI measured temperature for automatic control of ultrasound power and rotation rate

MRI Thermometry Sequence	<ul style="list-style-type: none"> ▪ EPI temperature sensitive proton resonance frequency shift induced phase difference ▪ >12 slice axial, 4 to 5 mm thickness, in-plane resolution of 2 mm (approx.), refresh rate 5 to 7 sec.
Thermometry precision	+/- 1° C or better
Thermal dose precision	+/- 35% or better

TREATMENT DELIVERY CONSOLE

Computer and software for treatment planning, temperature mapping, ablation feedback, therapy guidance and communication with Magnetic Resonance (MR) scanner

Computer	Intel Core i9-9900K, 2x8Gb RAM, 1TB HD, Mains Power: 100-240Vac, 50/60Hz, 500W
Monitor	24" LCD display, 1920x1080 resolution, mains Power: 100-240Vac, 50/60Hz, 20W
MRI Compatibility (Ask your authorized Profound Medical representative about TULSA-PRO® compatibility with your MRI system)	<ul style="list-style-type: none"> • Siemens: Skyra 3T, Prisma 3T, Vida 3T, Vida Fit 3T, Aera 1.5T, Sola 1.5T, Altea 1.5T, Lumina 3T • Philips: Achieva 3T, Ingenia 3T, Ingenia Elition 3T, Ingenuity PET-MR 3T, Ingenia 1.5T, Ingenia Evolution 1.5T • GE: 750W 3T, Architect 3T, Pioneer 3T, Premier 3T <p>Note: MRI systems must comply with IEC 60601-2-33 for basic safety and essential performance of magnetic resonance equipment for medical diagnosis.</p>

GENERAL

Operating Environment	Temperature: +15°C to +30°C	Humidity: 5% to 95% non-condensing
Storage & Transport (equipment)	Temperature: -40°C to +70°C	Humidity: 5% to 95% non-condensing
Storage & Transport (disposables)	Temperature: -25°C to +50°C	Humidity: 5% to 95% non-condensing

Appendix C. Regulatory Compliance

The TULSA-PRO® System was designed and developed in accordance with design control principles as outlined in ISO 13485:2016 (Sec 7.3), FDA 21CFR820.30, and applicable sections of essential requirements in accordance with Annex I of the Medical Device Directive 93/42/EEC.

Safety Compliance:

- IEC 60601-1:2005+A1:2012 (Ed.3.1) Medical electrical equipment – Part 1: General requirements for basic safety and essential performance
- IEC 60601-1-2:2014+A2:2020 (Ed.4.1) Medical electrical equipment - Part 1-2: General requirements for basic safety and essential performance – Collateral standard: Electromagnetic compatibility - Requirements and tests
- IEC 60601-1-6:2010+A1:2013 (Ed.3.2) Medical electrical equipment - Part 1-6: General requirements for basic safety and essential performance - Collateral standard: Usability
- IEC 62366-1:2015 (Ed.1.0) Medical devices – Application of usability engineering to medical devices
- IEC60601-1-8:2006+A1:2012 (Ed.2.2) Medical electrical equipment - Part 1-8: General requirements for basic safety and essential performance - Collateral Standard: General requirements, tests and guidance for alarm systems in medical electrical equipment and medical electrical systems
- IEC 60601-1-10:2007+A1:2013 (Ed.1.2) Medical electrical equipment - Part 1-10: General requirements for basic safety and essential performance – Collateral Standard: Requirements for the development of physiologic closed-loop controllers
- IEC 60601-2-62:2013 (Ed.1.0) Medical electrical equipment – Part 2-62: Particular requirements for the basic safety and essential performance of high intensity therapeutic ultrasound (HITU) equipment
- EN ISO14971:2019+A11:2021 Medical devices – Application of risk management to medical devices
- IEC 62304:2006+A1:2015 (Ed.1.1) – Medical device software - Software life cycle processes
- IEC60529:1989+A1:1991+A2:2013 Degrees of protection provided by enclosures (IP Code)
- ISO 7010:2019 Graphical symbols – Safety colours and safety signs
- ISO 15223-1:2021 – Medical devices – Symbols to be used with information to be supplied by the manufacturer – Part 1: General requirements

Magnetic Resonance (MR) Safe as tested according to:

- ASTM F2052-15 – Standard Test Method for Measurement of Magnetically Induced Displacement Force on Medical Devices in the Magnetic Resonance Environment
- ASTM F2213-17 – Standard Test Method for Measurement of Magnetically Induced Torque on Medical Devices in the Magnetic Resonance Environment
- ASTM F2182-11 Standard Test Method for Measurement of Radio Frequency Induced Heating On or Near Passive Implants During Magnetic Resonance Imaging

- ISO \TS 10974:2018 (Ed.2.0) – Assessment of the safety of magnetic resonance imaging for patients with an active implantable medical device
- ASTM F2503-20 Standard Practice for Marking Medical Devices and Other Items for Safety in the Magnetic Resonance Environment

Any modification, servicing, or replacement of components contained in the TULSA-PRO® System will require evaluation to the requirements of the above safety standards.

The TULSA-PRO® System is classified as Class I Medical Electrical Equipment suitable for continuous operation, as per IEC 60601-1. The UA and ECD are classified as Type BF Applied Parts.

The essential performances of the TULSA-PRO® can be found below, in accordance with IEC 60601-1 and related standards. These are in addition to basic electrical safety, which protects patients from high voltage and leakage currents.

- Do not display incorrect data (ultrasonic power, treatment area,) associated with the treatment being performed.
- Do not produce unwanted ultrasound output.
- Do not produce excessive ultrasound output.
- Do not generate excessive reflected ultrasonic power at the transducer-patient interface due to inadequate coupling.
- Do not target unwanted tissue regions away from the intended target region.
- Do not produce harmful thermal or mechanical tissue damage in or distal to the region of interest.

Reporting of Serious Incidents

A serious incident means any incident that directly or indirectly led, might have led or might lead to any of the following:

- a. the death of a patient, user, or other person
- b. the temporary or permanent serious deterioration of a patient's, user's, or other person's state of health
- c. a serious public health threat.

Any serious incident that has occurred in relation to the TULSA-PRO system must be reported to Profound Medical and to the regulatory authority in your jurisdiction. You may report to Profound Medical by contacting a Profound clinical or service representative, or through email to complaint@profoundmedical.com.

Table 2: Guidance and Manufacturer's declaration – electromagnetic emissions

The TULSA-PRO® System is intended for use in the electromagnetic environment specified below. Ensure the TULSA-PRO® System is used in such an environment.

EMISSIONS
TEST

COMPLIANCE

ELECTROMAGNETIC ENVIRONMENT - GUIDANCE

Radio Frequency (RF) emissions CISPR 11	Group 2	The TULSA-PRO® System emits electromagnetic energy to perform its intended function. Nearby electronic equipment can be affected.
RF emissions CISPR 11	Class A	When delivering treatment, use <u>only</u> the following electrical components of the TULSA-PRO® System in the Magnet Room: UA, UA cable, PS, PSIB, Filter Box to PSIB cable. The Filter Box, which is mounted on the MR penetration panel, provides electrical connectivity between the Magnet Room and the Control Room.
Harmonic emissions IEC 61000-3-2	Class A	All other components of the TULSA-PRO® System must be located outside the Magnet Room during treatment.
Voltage fluctuations/ flicker emissions IEC 61000-3-3	Complies	The TULSA-PRO® System is suitable for use in all establishments other than domestic and those directly connected to the public low-voltage power supply network that supplies buildings used for domestic purposes.

Table 3: Guidance and Manufacturer's declaration – electromagnetic immunity

The TULSA-PRO® System is intended for use in the electromagnetic environment specified below. Ensure the TULSA-PRO® System is used in such an environment.

IMMUNITY TEST	IEC 60601 TEST LEVEL	COMPLIANCE LEVEL	ELECTROMAGNETIC ENVIRONMENT – GUIDANCE
Electrostatic discharge (ESD) IEC 61000-4-2	± 8 kV contact ± 15 kV air	± 8 kV contact ± 15 kV air	Floors should be wood, concrete, or ceramic tile. If floors are covered with synthetic material, the relative humidity should be at least 30 %.
Electrical fast transient/burst IEC 61000-4-4	± 2 kV for power supply lines ± 1 kV for input/output lines	± 2 kV for power supply lines ± 1 kV for input/output lines	Mains power quality should be that of a typical commercial or hospital environment.
Surge IEC 61000-4-5	± 1 kV line(s) to line(s) ± 2 kV line(s) to earth	± 1 kV line(s) to line(s) ± 2 kV line(s) to earth	Mains power quality should be that of a typical commercial or hospital environment.
Voltage dips, short interruptions and voltage variations on power supply input lines IEC 61000-4-11	0 % \underline{U}_T , 0.5 cycle @ 0°, 45°, 90°, 135°, 180°, 225°, 270° and 315° 0 % \underline{U}_T , 1 cycle and 70 % \underline{U}_T , 25 cycles @ 50 Hz/30 cycles @ 60 Hz	0 % \underline{U}_T , 0.5 cycle @ 0°, 45°, 90°, 135°, 180°, 225°, 270° and 315° 0 % \underline{U}_T , 1 cycle and 70 % \underline{U}_T , 25 cycles @ 50 Hz/30 cycles @ 60 Hz	Mains power quality should be that of a typical commercial or hospital environment. If the TULSA-PRO® System needs continued operation during power mains interruptions, you should power the TULSA-PRO® System from an uninterruptible power supply or a battery.
Power frequency (50/60 Hz) magnetic field IEC 61000-4-8	30 A/m	30 A/m	Power frequency magnetic fields should be at levels characteristic of a typical location in a typical commercial or hospital environment.



NOTE: \underline{U}_T is the A.C. mains voltage before applying the test level.

Table 4: Guidance and Manufacturer’s declaration – electromagnetic immunity for medical electrical systems that are not life-supporting and are specified for use only in a shielded location

The TULSA-PRO® System is intended for use in the electromagnetic environment specified below. Ensure the TULSA-PRO® System is used in such an environment.

IMMUNITY TEST	IEC 60601 TEST LEVEL	COMPLIANCE LEVEL	ELECTROMAGNETIC ENVIRONMENT – GUIDANCE
Conducted RF IEC 61000-4-6	3V 0.15MHz - 80 MHz and 6V for ISM band	3V 0.15MHz - 80 MHz and 6V for ISM band	When delivering treatment, use <i>only</i> the following electrical components of the TULSA-PRO® System in the Magnet Room: UA, UA cable, PS, PSIB, Filter Box to PSIB cable. The Filter Box, which is mounted on the MR penetration panel, provides electrical connectivity between the Magnet Room and the Control Room. All other components of the TULSA-PRO® System must be located outside the Magnet Room during treatment.
Proximity Magnetic Fields IEC 61000-4-39	Per Table 11 of the standard.	65A/m 134.2kHz 7.5A/m 13.56Mhz	
Radiated RF IEC 61000-4-3	3 V/m 80 MHz to 2,7 GHz	3 V/m 80 MHz to 2,7 GHz	Field strengths outside the shielded location from fixed RF transmitters, as determined by an electromagnetic site survey, should be less than 3 V/m.*  Interference can occur near equipment marked with this symbol:



NOTE 1: These guidelines might not apply in all situations. Electromagnetic propagation is affected by absorption from structures, objects, and people.

NOTE 2: It is essential that the actual shielding effectiveness and filter attenuation of the shielded location they meet the minimum specification.

* Field strengths from fixed transmitters, such as base stations for radio (cellular or cordless) telephones and land mobile radios, amateur radio, AM and FM radio broadcast, and TV broadcast cannot be predicted theoretically with accuracy. To assess the electromagnetic environment due to fixed RF transmitters, consider an electromagnetic site survey. If the measured field strength outside the shielded location in which the TULSA-PRO® System is used exceeds 3 V/m, ensure that the TULSA-PRO® System operates normally. If you see abnormal performance, additional measures might be required, such as relocating the TULSA-PRO® System or using a shielded location with a higher RF shielding effectiveness and filter attenuation. Abnormal performance will be observed as alarms on the Treatment Delivery Console and an inability to deliver ultrasonic output.

Table 5: Test specifications for enclosure port immunity to rf wireless communications equipment

TEST FREQUENCY (MHZ)	MAXIMUM POWER (W)	DISTANCE (M)	IMMUNITY TEST LEVEL (V/M)
385	1,8	0,3	27
450	2	0,3	28
710			
745	0,2	0,3	9
780			
810			
870	2	0,3	28
930			
1 720			
1 845	2	0,3	28
1 970			
2 450	2	0,3	28
5 240			
5 500	0,2	0,3	9
5 785			

Appendix D. Ultrasound Beam Profile

This section provides background information about how Profound Medical designed the Ultrasound Applicator (UA) for use with its TULSA-PRO® System. Operators do not need this information for the proper operation of TULSA-PRO® and it should not affect how physicians plan treatments.

Test conditions

- The UA was filled with water and immersed in water for the test. The ultrasound signal was measured with a hydrophone with an active area of 0.20 mm in diameter.
- The pulse intensity integral (the integral over time of ultrasound intensity for the duration of one pulse) was recorded as a function of the hydrophone position.

The axes of the coordinates are as shown in *Figure 15*, with the z-axis normal to the surface of the transducer. The center of the xy plane ($x=0$, $y=0$) was taken as the point where the ultrasound signal was at its peak.

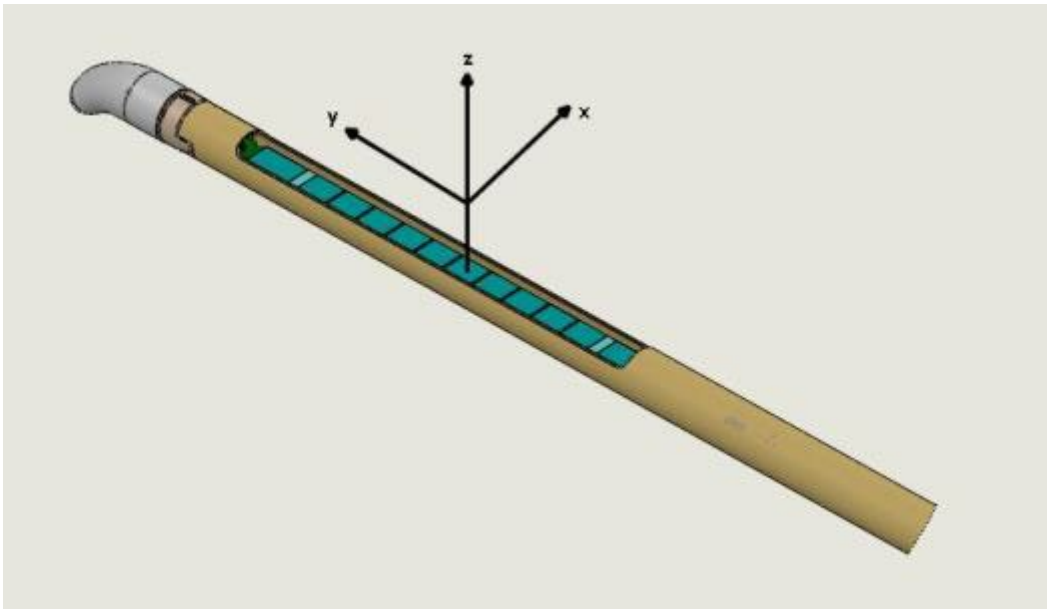

Figure 15: Axes of ultrasound transducer profile

Ultrasound profile in water

The ultrasound profile was recorded along the x-axis (*Figure 16*) and along the y-axis (*Figure 17*) at three distances from the transducer: $z=16$ mm, $z=24$ mm and $z=36$ mm. The ultrasound profile was also recorded along the z-axis (*Figure 18*).

The following graphs show how a typical ultrasound beam profile is generated by one UA element along each axis.

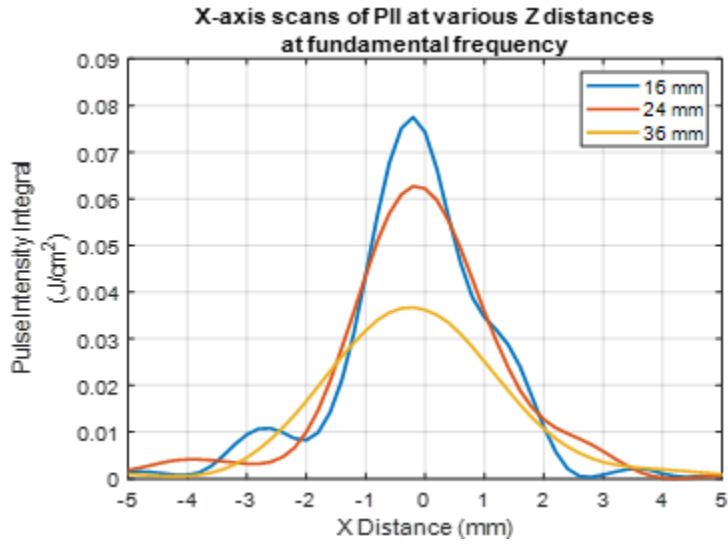

Figure 16: Ultrasound beam profile on X-axis

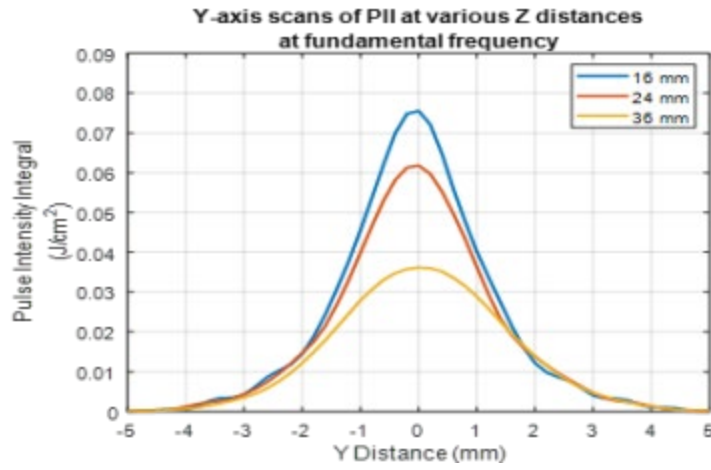

Figure 17: Ultrasound beam profile on Y-axis

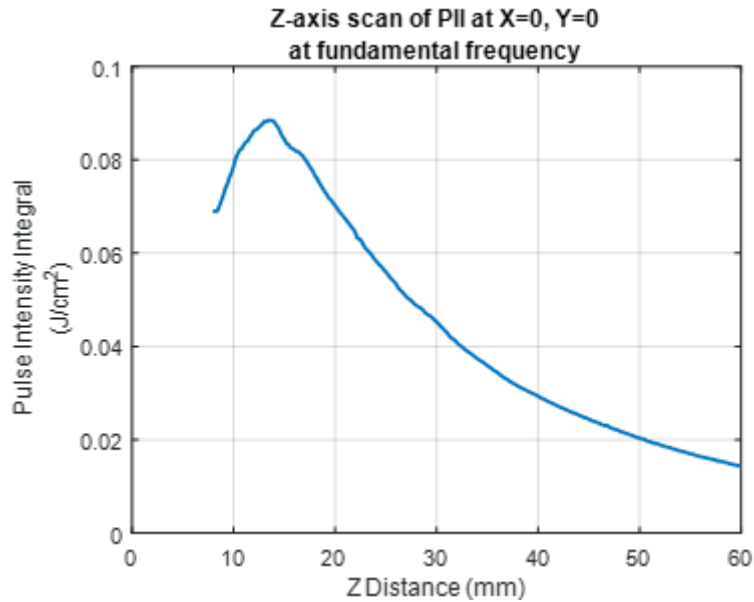

Figure 18: Ultrasound beam profile on Z-axis

Typical Temperature Profile

Figure 19 is a simulation of a typical temperature pattern in tissue. The pattern is characterized by a peak in temperature close to the transurethral device and aligned with the current direction of the ultrasound beam profile. The temperature at the target boundary will be lower than the peak temperature. Fig 19a shows the appearance of this temperature profile in two dimensions, relative to the position of the transurethral device. A horizontal profile of the temperature taken at Y=0 mm is shown in Figure 19 (b).

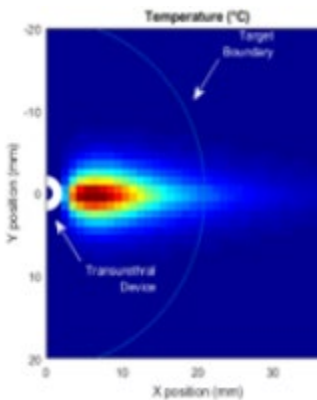

Figure a)

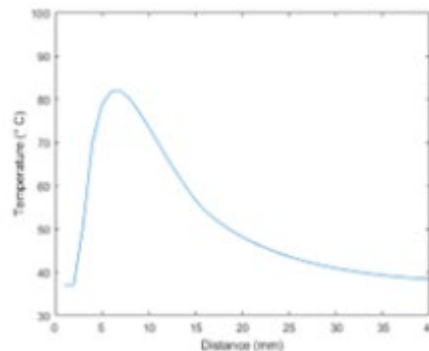

Figure b)

Figure 19: Typical ultrasound temperature profile in tissue

The simulated beam power was 4W acoustic at a frequency of 4.3 MHz, while ultrasound parameters in tissue were speed of sound = 1540 m/sec, and attenuation = 0.5 dB/cm/MHz.

Appendix E. TULSA-PRO® Education Program

Purpose of the Program

Patient safety and positive clinical outcomes for patients treated with the TULSA-PRO® depend on qualified operators who can deliver ultrasound ablation treatment in a safe and consistent manner and based on the system's intended use and this manual's instructions.

Every hospital or clinic performing patient treatments with the TULSA-PRO® System requires at least two operators trained on the safe and proper use of the system. It is beneficial if additional medical personnel (such as the anesthesia team and nurses) also familiarize themselves with the system components and workflow to ensure a smooth and low-risk procedure.

Training Outline and Formats

Profound Medical personnel deliver the TULSA-PRO® education program. The following training material is delivered in the specified formats:

CATEGORY	TRAINING TOPICS	FORMAT
Overview and theory of operation	<ul style="list-style-type: none"> • Introduction to TULSA-PRO® System's intended use and intended patient population • TULSA theory of operation • System equipment and setup (site requirements including supported MRI systems) • Treatment workflow overview • Software interface overview (sample images for device positioning, treatment planning including boundary selection and safety margins, treatment delivery) • Patient preparation • Risks and side effects of TULSA-PRO® System and procedure 	Webinar or Classroom-style presentation
Hands-on demonstration of TULSA-PRO® System	<ul style="list-style-type: none"> • Review MRI safety • Simulated patient workflow with full equipment (patient preparation, anesthesia considerations, patient transfer to MRI table, MRI coil placement, device insertion, MR imaging, treatment planning, treatment delivery, patient transfer to recovery area) 	In-person, hands-on demonstration in MRI suite in a simulated patient environment (such as a tissue-

- Equipment setup (TULSA-PRO® components, cable routing, cooling fluid and tubing, pre-use device checks) mimicking gel phantom)
- Software demonstration and treatment delivery in tissue-mimicking gel phantom (hands-on review of software alarms and troubleshooting tips)
- Equipment dismantling, storage, maintenance, and single-use product disposal

Coaching and monitoring	<ul style="list-style-type: none"> • Observation, guidance, and question-answering • Assess effectiveness of program and need for additional material 	In-person, on-site with Profound Medical personnel
--------------------------------	---	--

Appendix F. Equipment and Accessories

The following is a complete listing of TULSA-PRO® equipment and accessories, with model numbers. All equipment is supplied by Profound Medical and substitutions or modifications are not permitted.

• TULSA-PRO System Electronics	104470
• TULSA-PRO Positioning System	104491, 106585, 112192
• TULSA-PRO System Cart	104492
• TULSA-PRO Cable – System Electronics to System Cart, 120ft	105152
• TULSA-PRO Positioning System Interface Box (PSIB)	104494, 106515
• TULSA-PRO Treatment Delivery Console	104495
• TULSA-PRO TDC Monitor 23-24", 1920x1980 resolution	105122
• TULSA-PRO Filter Box	104493, 106604
TULSA-PRO Cables and Accessories	
• TULSA-PRO Cable – System Electronics to Filter Box, 25ft	103705
• TULSA-PRO Cable – Filter Box to PSIB, 40ft	103708, 106475
• TULSA-PRO Cable – UA to PSIB, 3.0T PHILIPS	105486
• TULSA-PRO Cable – UA to PSIB, 3.0T PHILIPS & GE	106708
• TULSA-PRO Cable – UA to PSIB, 3.0T SIEMENS	105485, 106955
• TULSA-PRO Cable – UA to PSIB, 1.5T PHILIPS	106647
• TULSA-PRO Cable – UA to PSIB, 1.5T SIEMENS	107189
• TULSA-PRO Cable – PS to PSIB, 3.0T	106582
• TULSA-PRO Cable – PS to PSIB, 1.5T	106583
• TULSA-PRO Penetration Panel Kits	104496
• Cover Plate Assembly	104951
• PHILIPS MRI Network Kit NA	104301
• SIEMENS MRI Network Kit (Optional)	105624
• TULSA-PRO Language Kits	
• English	105803
• French	105804
• Italian	105805
• German	105806

Appendix F. Equipment and Accessories

• Spanish	105807
• Finnish	107146
• Japanese	108288
• Korean	112987
• Keyboard and Mouse (Available in English, French, Italian, German, Spanish)	
<hr/>	
• TULSA-PRO Power Cords Kit	
• Power Cord – North America	104904
• Power Cord – Europe	104905
• Power Cord – United Kingdom	104907
• Power Cord – Australia and New Zealand	105823
• Power Cord – Italy	105824
• Power Cord - Switzerland	105825
• Power Cord - Denmark	105826
• Power Cord – Japan	110985
• Power Cord – Korea	112612
<hr/>	
TULSA-PRO Philips Magnet Kits	
• TULSA-PRO Magnet Kit INGENIA	105392
• TULSA-PRO Base Plate – INGENIA	105464
• TULSA-PRO Coil Holder – INGENIA	105469
• TULSA-PRO Coil Holder Pad – INGENIA	105470
• TULSA-PRO Leg Support – INGENIA	105465
• TULSA-PRO Head Pad – INGENIA	105471
<hr/>	
• TULSA-PRO Base Plate – INGENIA 1.5T	109589
• TULSA-PRO Base Plate – INGENIA 1.5T	106725
• TULSA-PRO Leg Support – INGENIA 1.5T	109590
• TULSA-PRO Patient Pad – INGENIA 1.5T	109074
<hr/>	
• Magnet Kit Straps and Clips	Various
<hr/>	
TULSA-PRO Siemens Magnet Kits	
• TULSA-PRO Magnet Kit – SIEMENS Bed 518.5mm PITCH	107861
• TULSA-PRO Base Plate – SIEMENS Bed 518.5mm PITCH	107249

Appendix F. Equipment and Accessories

• TULSA-PRO Leg Support – SIEMENS	107286
• TULSA-PRO Patient Pad – SIEMENS	107320
<hr/>	
• TULSA-PRO Magnet Kit – SIEMENS Bed 511.5mm PITCH	108053
• TULSA-PRO Base Plate – SIEMENS Bed 511.5mm PITCH	107248
• TULSA-PRO Leg Support – SIEMENS	107286
• TULSA-PRO Patient Pad – SIEMENS	107320
<hr/>	
• TULSA-PRO Magnet Kit – SIEMENS Bed 515.7mm PITCH	109312
• TULSA-PRO Base Plate – SIEMENS Bed 515.7mm PITCH	109313
• TULSA-PRO Leg Support – SIEMENS	107286
• TULSA-PRO Patient Pad – SIEMENS	109071
• Magnet Kit Straps and Clips	Various
<hr/>	
• TULSA-PRO GE Magnet Kits	
• TULSA-PRO Magnet Kit – GE	111219
• TULSA-PRO Base Plate – GE	110499
• TULSA-PRO Leg Support – Long	110133
• TULSA-PRO Patient Pad – GE	110497
• Magnet Kit Straps and Clips	Various
<hr/>	
• TULSA-PRO GE Magnet Kits – Universal	
• TULSA-PRO Magnet Kit – Universal	112176
• Base Plate Assembly – Universal	111784
• Leg Support Assembly – Universal	112161
• Foam Assembly for PHK+	112199
• Leg Support Padding	111768
• Magnet Kit Straps and Clips (MRI-specific)	Various
<hr/>	
• TULSA-PRO Disposable Kit	111020, 112562
• TULSA-PRO Ultrasound Applicator	104008
• TULSA-PRO Endo-rectal Cooling Device	109171
• TULSA-PRO Tube Set – UA	104010, 112563

Appendix F. Equipment and Accessories

- TULSA-PRO Tube Set – ECD 104011
- TULSA-PRO Span & Tween - ECD Fluid Supplement 104719
- TULSA-PRO® Manganese Chloride - ECD Fluid Supplement 105526