

TULSA-PRO[®]

A thick blue horizontal line with a circular dot at the right end, positioned below the 'TULSA-PRO' text.

TULSA-PRO[®] Transurethral Ultrasound
Ablation System

Operator's Manual

Philips

PROFOUND

A thick blue horizontal line with a circular dot at the right end, positioned below the 'PROFOUND' text.

Publisher's Notice

TULSA-PRO® SYSTEM Model Number: PAD-105

Operator's Manual for Philips

Document Number: 105774 REV P

Change Control Number: CO-08274

Published By:



Profound Medical Inc.

2400 Skymark Avenue, Unit 6
Mississauga ON L4W 5K5

Phone: 647-476-1350

Fax: 647-847-3739

<http://www.profoundmedical.com/>



EUROPEAN AUTHORIZED REPRESENTATIVE:

MDSS GmbH
Schiffgraben 41
30175 Hannover, Germany

Copyright © 2026 Mississauga, Canada.

All rights reserved. No part of this document may be reproduced or transmitted in any form or by any means, electronic, mechanical, photocopying, recording, or otherwise, without prior written permission from Profound Medical Inc.

TULSA-PRO® System is protected by U.S. and foreign patents.



Federal law restricts this device to sale by or on the order of a Physician.

Table of Contents

PUBLISHER'S NOTICE	2
TABLE OF CONTENTS	3
1. INTRODUCTION	8
2. ABBREVIATIONS	9
3. GENERAL INSTRUCTIONS	10
3.a Suggested Personnel	10
3.b Workflow Overview	10
3.c Operator, Personnel, and Patient Requirements	11
3.d TULSA-PRO® System Commissioning	11
4. PATIENT ADMISSION AND PREPARATION	12
5. EQUIPMENT SETUP	13
5.a Quick Start Guide for TULSA-PRO® Equipment Setup	13
5.b Setup Inside the MRI Magnet Room	15
5.b.i Setting up the Base Plate, Coil Holder, Patient Pad, and Straps	15
5.b.ii Preparing a Work Surface and Connecting the Positioning System (PS)	16
5.c Preparing the System Cart Outside the MRI Magnet Room	16
5.c.i Cart Setup	16
5.c.ii Preparing Fluid Circuits	17
5.d Powering on the System Electronics	19
5.e Registering a Patient on the MRI Console	19
5.f Preparing the Treatment Delivery Console (TDC)	20
5.f.i TDC Computer Setup	20
5.f.ii Treatment Delivery Console (TDC) Start Screen	20
5.g Performing Pre-treatment QA Steps	22
5.g.i PS test	22
5.g.ii UA and ECD Preparation	24
5.g.iii RF connectivity test	28
5.g.iv Preparing ECD Lubricant Channels	29
6. INITIAL PATIENT POSITIONING	32
7. DEVICE INSERTION	34
7.a Inserting the ECD	34
7.a.i To insert the ECD the first time:	34
7.b Preparing the UA	35
7.c Inserting the UA	36

7.d Docking the Ultrasound Applicator to the Positioning System	36
8. MRI PATIENT POSITIONING	39
8.a Securing the Patient	39
8.b Device Check	41
9. TREATMENT PLANNING	42
9.a Initial Imaging	42
9.a.i MRI sequence protocol and instructions	42
9.a.ii Entering Treatment Milestones	43
9.b Checking Gross Device Positioning	43
9.b.i Reviewing initial device positioning	43
9.b.ii Adjusting device positioning	45
9.b.iii Pushing and loading planning images from the MRI to TDC	46
9.c Alignment	47
9.d Coarse Planning	48
9.e Detailed Planning	51
9.e.i Acquiring the treatment planning images	51
9.e.ii Treatment planning guidelines	53
9.e.iii mpMRI Vision	56
9.e.iv Treatment Arc	57
9.e.v Contouring Assistant	58
9.e.vi TULSA-AI Volume Reduction (VR)	59
10. TREATMENT DELIVERY	62
10.a Starting position and direction of rotation	62
10.b Treatment Initialization	63
10.b.i Monitoring Treatment Delivery	65
10.c Toggling Power to One or More Treatment Elements	66
10.d Adjusting Treatable Volume Selection During Delivery	67
10.e Adjusting Beam Alignment during Treatment	68
10.f Delivery Paused	71
10.g Editing the Prostate Boundary during Treatment	73
10.h Creating a new Treatment Segment	74
10.i History Slider	75
10.j Thermal Boost	77
11. POST-TREATMENT IMAGING AND REPORTS	79
11.a Post-treatment Imaging	79

11.b Entering Treatment Milestones	79
11.c Treatment Reports	80
11.c.i Viewing treatment videos	81
11.c.ii Exporting reports and videos	82
11.d Post-treatment Session Export	83
12. DEVICE REMOVAL AND PATIENT RECOVERY	85
12.a Device Disconnection	85
12.b Device Removal	85
12.c Patient Recovery	86
12.d Equipment dismantling	86
13. CLEANING AND DISPOSAL	87
13.a Disposables	87
13.a.i Ultrasound Applicator (UA)	87
13.a.ii Endorectal Cooling Device (ECD)	87
13.a.iii Fluid Tubing	87
13.b Reusable Equipment Cleaning & Disinfection	87
13.b.i General Cleaning and Disinfection	87
13.b.ii General Cleaning Reagents, Methods, and Tools	88
13.b.iii Performing Manual Cleaning and Disinfection	89
13.b.iv Positioning System – Cleaning and Disinfection Instructions	90
13.b.v Base Plate – Cleaning and Disinfection Instructions	91
14. SOFTWARE ALARMS	93
14.a Alarm Indicators	93
14.b Description of Alarm Conditions	94
14.c Multiple Alarm Conditions	96
14.d Alarm Condition Log	97
15. USER ACCOUNTS	98
15.a Login During Treatment	98
15.b Account Management	98
APPENDIX A. TULSA-PRO® MRI TROUBLESHOOTING TIPS	99
Patient motion concerns	99
Thermometry and temperature uncertainty	99
Access to User Documentation from TDC	100
APPENDIX B. MRI TECHNOLOGIST CHECKLIST FOR PHILIPS	101
EQUIPMENT SETUP	101

B.0.i Inside the MRI magnet room	101
B.0.ii Outside the MRI magnet room	101
B.0.iii Inside the MRI magnet room	102
Initial Patient Positioning	103
Device Insertion	103
MRI Patient Positioning	104
Treatment Planning	104
Delivery	105
Post-Treatment Imaging	105
Device Removal and Patient Recovery	105
Cleaning and Disposal	106
APPENDIX C. TROUBLESHOOTING GUIDE	107
Symptoms, Causes, and Solutions	107
Alarm Signals	109
C.1. FLUID CART	111
40-201: TDC lost a network connection to the System Cart	111
40-202: The cable between the System Cart and the System Electronics has been disconnected	112
40-206: The room temperature for the System Cart is too high	114
41-107: The Ultrasound Applicator fluid-circuit bag volume is too low	115
41-109: The Ultrasound Applicator fluid-circuit pump pressure is too low	117
41-110: The Ultrasound Applicator fluid-circuit pump pressure is too high	119
42-107: The ECD fluid-circuit bag volume is too low	120
42-109: The ECD fluid-circuit pump pressure is too low	122
42-110: The ECD fluid-circuit pump pressure is too high	124
C.2. MAGNETIC RESONANCE IMAGING	126
50-201: The IP address or port for the MRI cartridge is wrong or in use	126
50-202: TDC lost network connection to the MRI	127
50-203: There is a delay in receiving the thermometry image	128
50-204: TDC has not received new thermometry images in the last 30 seconds	129
50-209: The thermometry images cannot be used	130
50-211: The thermometry scan does not match the prescribed image position or orientation	132
50-212: Someone changed the thermometry sequence parameters and they are out of range	134
50-213: The thermometry images cannot be used	135

50-214: The anatomy scan required for alignment is older than 2 hours.	137
50-215: Check that the patient is in a head-first, supine position	138
C.3. POSITIONING SYSTEM	139
10-102: TDC lost the network connection to the Positioning System Interface Box	139
20-102: The cable between the Positioning System (PS) and PS Interface Box is dis- connected	140
20-201: There is a problem with the rotary motion	142
20-202: The TDC computer is busy and cannot process thermometry images fast enough	143
20-203: Something went wrong with the Positioning System communications	144
21-201: The Positioning System's linear axis moved unexpectedly	145
22-201: The Positioning System is not rotating the Ultrasound Applicator at the expected rate	146
22-202: The rotary home position has been lost	147
22-206: The Ultrasound Applicator (UA) has rotated too far in one direction	148
22-208: The Positioning System's rotary axis moved unexpectedly	149
C.4. RADIO FREQUENCY	150
30-201: Emergency switch button has been activated	150
30-202: The TDC computer is busy and cannot process thermometry images fast enough	151
31-201: The System Electronics amplifiers are overheating	152
31-202: The System Electronics amplifiers have turned off	153
32-102: TDC lost the network connection to the System Electronics	154
C.5. SYSTEM	155
71-202: There is not enough hard-drive storage space to complete this session ...	155

1. Introduction

This guide contains operating instructions for setting up and operating the TULSA-PRO® Transurethral Ultrasound Ablation System, and for preparing and positioning patients with specific information for your specific Magnetic Resonance Imaging (MRI) platform.

You must use these instructions along with the *TULSA-PRO® Instructions For Use* for the TULSA-PRO® Transurethral Ultrasound Ablation System, which contains all regulatory information about the TULSA-PRO® system, including warnings and cautions that are essential for the safe and proper use of this medical device system.

If you need additional copies of the *TULSA-PRO® Instructions For Use* or *TULSA-PRO® Operator's Manual* for any MRI system, or have questions about this document's contents, please contact:



Profound Medical Inc.

2400 Skymark Avenue, Unit 6 Mississauga ON L4W
5K5

Phone: 647-476-1350

Fax: 647-847-3739

<http://www.profoundmedical.com/>



NOTE: On any TDC screen—except during Treatment Delivery—you can press F1 on your keyboard to open and review a PDF copy of the *TULSA-PRO® Operator's Manual*. Click **X** in the top corner of the PDF viewer to close the document window.

2. Abbreviations

This manual uses the following abbreviations:

ECD	Endorectal Cooling Device
MR	Magnetic Resonance
MRI	Magnetic Resonance Image/Imaging/Imager
PS	Positioning System
PSIB	Positioning System Interface Box
TDC	Treatment Delivery Console software
TULSA-PRO	Transurethral Ultrasound Ablation System
UA	Ultrasound Applicator

3. General Instructions

3.a Suggested Personnel

The following table describes the suggested roles and responsibilities required for a TULSA-PRO® procedure. At your site, some personnel might perform multiple roles. Instructions throughout this manual are color-coded by role based on the shading colors in the following table.

ROLE	TYPICAL ACTIVITIES WITHIN A TULSA-PRO® PROCEDURE
Urologist	<ul style="list-style-type: none"> • Patient inclusion and education (assess patient suitability, discuss risks and benefits of TULSA, visits, and follow-up care) • Device management (catheter, guidewire, Ultrasound Applicator, and Endorectal Cooling Device) • TULSA-PRO® Software operation (same as for <i>Radiologist</i>)
Radiologist	<p>TULSA-PRO® Software operation:</p> <ul style="list-style-type: none"> • Device positioning and alignment with anatomy • Treatment planning (contour prostate gland and prescribe control boundary) • Treatment delivery monitoring (watching for expected ablation and software alarms)
MRI Technologist	<ul style="list-style-type: none"> • Assessment of Magnetic Resonance Imaging (MRI) eligibility of patient and personnel required in MR environment • TULSA-PRO® equipment setup, dismantling, and storage • Patient and equipment positioning in MRI magnet room • Operation of MRI console for image acquisition
Anesthesiologist (or nurse anesthetist)	<ul style="list-style-type: none"> • Assessment of patient suitability for anesthetic • Sedation in the preparation area or MRI scanner room • Monitoring and adjusting sedation level during treatment planning and delivery • Patient recovery following ablation procedure and transfer to post-anesthesia care

3.b Workflow Overview

The following table summarizes the workflow of a TULSA-PRO® procedure. Steps involving multiple personnel or performed in parallel are listed on the same row. The primary role for each step is indicated in **bold**. Steps requiring Anesthesiologist support are labeled with an asterisk (*). Subsequent sections of this document begin with a quick start summary guide, followed by detailed instructions for each step.

3. General Instructions

UROLOGIST	RADIOLOGIST	MRI TECHNOLOGIST
Patient Admission *		Patient MRI Screening
Patient Preparation *		Equipment Setup
		Initial Patient Positioning *
Device Insertion –ECD and UA		Device Insertion – ECD and UA
		MRI Patient Positioning *
	Initial Imaging	Initial Imaging
	Planning – Alignment	Planning – Alignment
	Planning – Coarse	Planning – Coarse
	Planning – Detailed *	Planning – Detailed *
Treatment Delivery *	Treatment Delivery *	Treatment Delivery *
	Post Treatment Imaging	Post Treatment Imaging
Patient Recovery *		Equipment Dismantling

3.c Operator, Personnel, and Patient Requirements

All personnel and operators who install and handle the TULSA-PRO® **must** receive training on equipment setup.

The patient and all operators entering the MRI magnet room must be screened by Radiology or MRI Personnel and must complete an MRI Screening Form.

Operators who set up equipment must be careful within the MR environment and must not enter the MR environment with any MR-Unsafe items in their pockets or on a tray or cart. The TULSA-PRO® equipment has been designed so that tools (such as screwdrivers and wrenches) are not required for setup.

3.d TULSA-PRO® System Commissioning

Before first using the TULSA-PRO® System at any MRI site, the system **must** undergo initial setup and acceptance testing by service personnel authorized by Profound Medical.

- Setup involves calibrating Fluid Circuit sensors and verifying the correct electrical connections.
- Acceptance testing verifies operation of equipment within the MRI environment.
- Service personnel will also configure the name and address of your site as it should appear in treatment reports (see *Exporting reports and videos*).

4. Patient Admission and Preparation

Patient admission and preparation is led by the **Urologist**, with assistance from the **Anesthesiologist** and the **MRI Technologist**.

After being admitted, the patient is taken to the MRI patient preparation area.

1. **MRI Technologist**: Screen the patient for MRI eligibility and obtain information needed to register the patient on the MRI computer.
2. **Anesthesiologist**: It is recommended you administer general anesthesia for patients undergoing this procedure.
3. **Urologist**: A supra-pubic catheter can be placed in the patient's bladder under cystoscope guidance to drain urine from the bladder and manage the urine flux during the procedure. If a supra-pubic catheter is not used, drain the bladder using a Foley catheter and fill with a small volume of sterile water before inserting the guidewire. If a guidewire is not used, have the patient void shortly before the procedure.
4. **Urologist**: Under cystoscope guidance or using a Foley catheter, insert a maximum 0.96 mm (0.038 in) non-magnetic guidewire (such as Nitinol core) into the prostatic urethra and into the bladder.



Only use a guidewire that has been verified to be non-magnetic.

Do not acquire MR images while a guidewire is in the patient. Electric currents induced by the MRI in the guidewire could cause thermal injury to the patient or physician.

5. **Urologist**: Remove the cystoscope or Foley catheter and leave the guidewire in place. If this step is done outside the MRI magnet room, secure the guidewire to prevent it from falling out of the patient during transfer to the MRI bed.



Remove the cystoscope from the patient before entering MRI magnet room, or you can injure the patient.

5. Equipment Setup

5.a Quick Start Guide for TULSA-PRO® Equipment Setup

MRI Technologist: Complete the equipment setup for the TULSA-PRO® by following these steps:

- inside the MRI magnet room:
 - set up the TULSA-PRO® base plate, coil holder/patient pads, clips, and straps on the MRI bed
 - prepare a work surface and connect the Positioning System Interface Box to the Filter Box and Positioning System
- outside the MRI magnet room:
 - obtain two 1L sterile water bags and the TULSA treatment kit from the storage location
 - prepare the System Cart:
 - place the System Cart near the waveguide and raise the System Cart pole
 - transfer sterile water for the Ultrasound Applicator (UA) and doped sterile water for the Endorectal Cooling Device (ECD) for the respective UA and ECD reservoir bags
 - hang the UA and ECD reservoir bags (with clamped ends) on the System Cart and connect the tubing to the pump and pressure outlets
 - pass the capped ends of tube sets through the waveguide to an assistant inside the MRI magnet room
 - confirm that the System Electronics are connected to the Treatment Delivery Console, Filter Box, and power outlet, and power on the System Electronics
 - register a new patient on the MRI console
 - power on the Treatment Delivery Console (TDC), launch a new session, and turn on PSIB Display
- inside the MRI magnet room, perform pre-treatment equipment checks:
 - connect the tube sets through the waveguide to the UA and ECD on the MRI work surface and unclamp the tubes
 - start the Positioning System (PS) Test
 - while the PS test is running, purge the UA and ECD and, when complete, check for bubbles
 - after the purge is complete, connect the UA and PSIB, and perform RF Connectivity Test
 - if using an ECD with lubricant channels, prime the green and black channels of the ECD with lubricant.

5. Equipment Setup

All electrical cables running into the MRI magnet room are connected through a filter box located on a penetration panel. All fluid lines running into the MRI magnet room are passed through a waveguide.

Figure 1 shows a schematic of the TULSA-PRO® equipment setup.

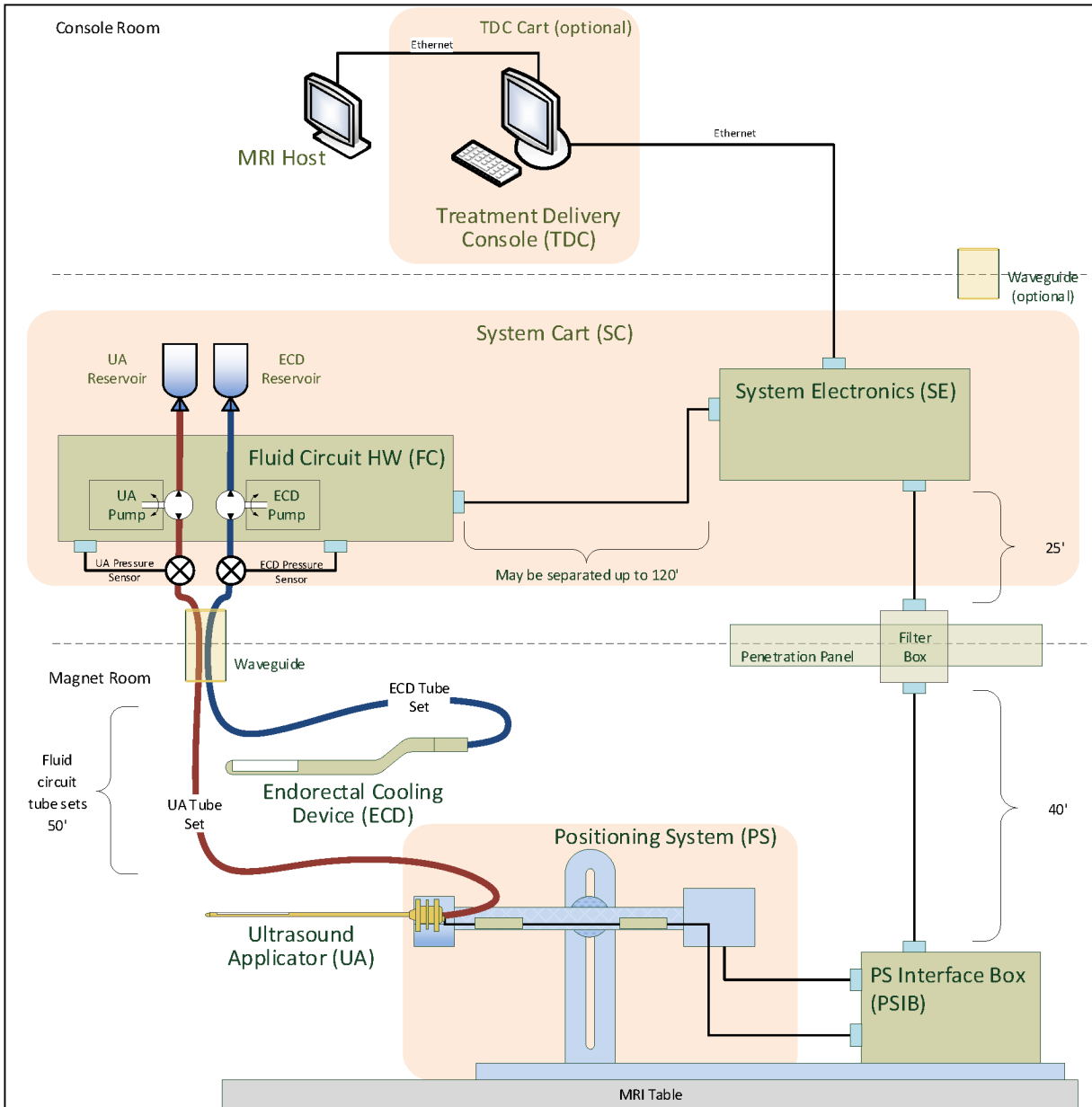

Figure 1: Schematic of TULSA-PRO® equipment setup

5.b Setup Inside the MRI Magnet Room

5.b.i Setting up the Base Plate, Coil Holder, Patient Pad, and Straps

1. **MRI Technologist** Attach the base plate onto the foot end of the MRI table and secure using the four base plate straps (*Figure 2*, your configuration might not match exactly as shown). The feet of the base plate should fit in the rails of the MRI table and not move around when in position.

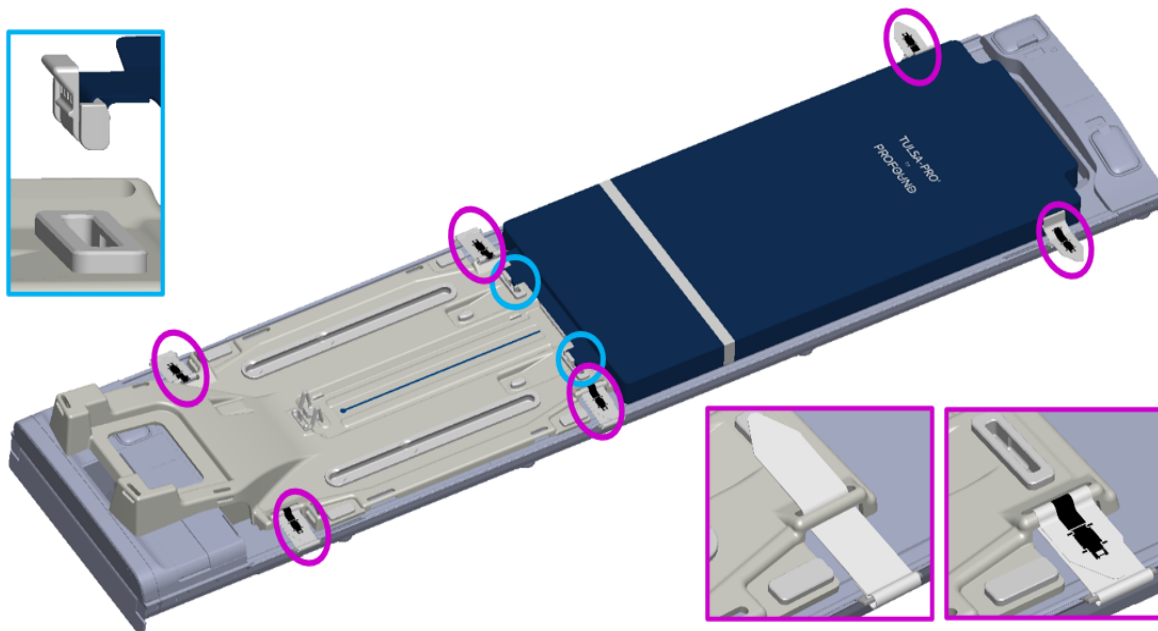

Figure 2: Securing the base plate and patient pad to the MRI bed

2. Place the coil in the TULSA-PRO Coil Holder, buckle the straps, and cinch them tightly. Place the Coil Holder with the posterior coil onto the MRI table, with the cable exiting the coil holder towards the head of the MRI table. Place the TULSA-PRO® head pad above the coil holder (*Figure 3*).

5. Equipment Setup

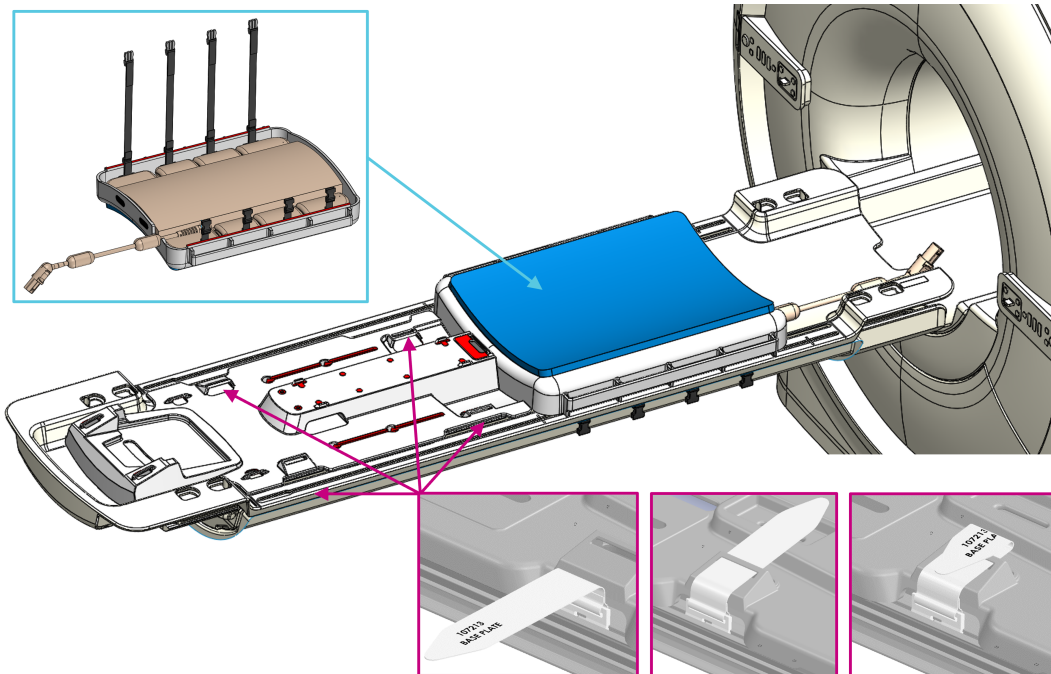

Figure 3: Securing base plate, coil holder (top), and patient pad (bottom)

3. Drape a sheet across the upper part of the patient pad and place an absorbent pad at the end closest to the base plate.

5.b.ii Preparing a Work Surface and Connecting the Positioning System (PS)

1. **MRI Technologist:** In the MRI magnet room, place the Positioning System and Positioning System Interface Box (PSIB) on a work surface. Manually move the PS backward as far as possible using the adjustment release.
2. Connect the PS cable between the PS and the PSIB. Connect the large white cable from the Filter Box (on the wall on the inside of the MRI magnet room) to the PSIB.



Be careful when installing the cable between the Filter Box and the PSIB. The cable pins must be carefully mated to the receptacle connector and not forced into place. Too much force will damage the cable pins.

5.c Preparing the System Cart Outside the MRI Magnet Room

MRI Technologist: The System Cart contains the fluid circuit hardware used to cool the Ultrasound Applicator (UA) and the Endorectal Cooling Device (ECD). Here is how to prepare the System Cart:

5.c.i Cart Setup

1. To provide access for the fluid tubes, position the System Cart near a waveguide in the equipment room. Ensure that airflow from the rear vent is not obstructed.

5. Equipment Setup

2. Lock the casters on the wheels to fix the System Cart in place.
3. While pressing the pole clamp release, raise the System Cart pole to its fully extended position.

5.c.ii Preparing Fluid Circuits



The ECD fluid supplements are not safe for drinking and should not come into skin contact. Use gloves when handling and do not ingest.

The fluid circuit tube sets have color-coded stickers and Luer fittings to distinguish them: red and white for the UA circuit, blue and yellow for the ECD circuit.

1. Prepare two 1000mL IV bags of sterile water.
 - One will be the UA IV bag.
 - Set aside the other 1000 mL IV bag containing untreated, sterile water. This will be treated with fluid supplements and used for the ECD fluid circuit.
2. Remove the UA tube set (identified with a red dot) from its packaging, close the line clamps near the ends of the tubes, and lay the empty UA reservoir bag on top of the Fluid Circuit tabletop.



NOTE: To avoid spills, ensure that the line clamps near the capped ends of the tube set are closed.

3. Insert the spike from the empty UA reservoir bag into an untreated UA IV bag, and then open the line clamp by the spike port to allow the contents of the UA IV bag to be transferred to the UA reservoir bag.
4. While the UA bag is filling, prepare the ECD IV bag:
 - Use a 30-60mL syringe with a 16G needle to extract 5mL of ECD Fluid Supplement – Manganese Chloride. Inject this solution into the syringe port of the ECD IV bag.
 - Withdraw 20mL of ECD Fluid Supplement – Span & Tween. Inject this solution into the syringe port of the ECD IV bag.
 - Shake the ECD IV bag for 30 seconds or until the solution is fully dissolved. The solution should look milky white, which will help you distinguish the ECD IV bag from the UA IV bag.



NOTE: The additives Manganese Chloride and Span & Tween eliminate MRI signal and help prevent bubbles in the fluid within the ECD and ECD fluid line. Do not refrigerate the sterile water or the ECD additives. When cold, the additives do not mix well and take longer to dissolve.

5. Insert the spike from the empty ECD reservoir bag (identified with a blue dot) into the treated ECD IV bag, and then open the line clamp by the spike port to allow the contents of the treated ECD IV bag to transfer into the ECD reservoir bag.
6. When all the contents from the UA and ECD IV bags have been transferred to reservoir bags, close the line clamps in between.

5. Equipment Setup

- a. For each tube set, hang the reservoir bag on the corresponding color-coded weight sensor hook on the System Cart (*Figure 4*).
- b. Place the pump section of each tube set into the corresponding pump head and close it.
Avoid pinching the pump section of the tubing when installing it into the peristaltic pump head. Pay attention to both the top and bottom (inlet and outlet) of the pump head.



NOTE: If the tubing is pinched in the pump head, the tubing could fail in the middle of a treatment and cause a large water leak.

- c. Connect the ECD pressure sensor to the corresponding connection on the System Cart.
7. With assistance from someone inside the MRI magnet room, pass the UA and ECD tube sets (capped ends) through the appropriate waveguide, into the MRI magnet room. Have them coil the tube sets separately, leaving slack on the ends for connection, and secure the tube sets near the MRI work surface.



Do not inject ECD fluid supplement into the UA fluid bag, because:

- The ECD-fluid additives will eliminate the MRI signal shown from the water in the UA acoustic window, which is important during the *Alignment* phase of treatment planning. In other words, you might not properly identify the UA acoustic window and could misalign the UA.
- You increase the risk of infection if the treated fluid should leak out of the UA and into the urethra

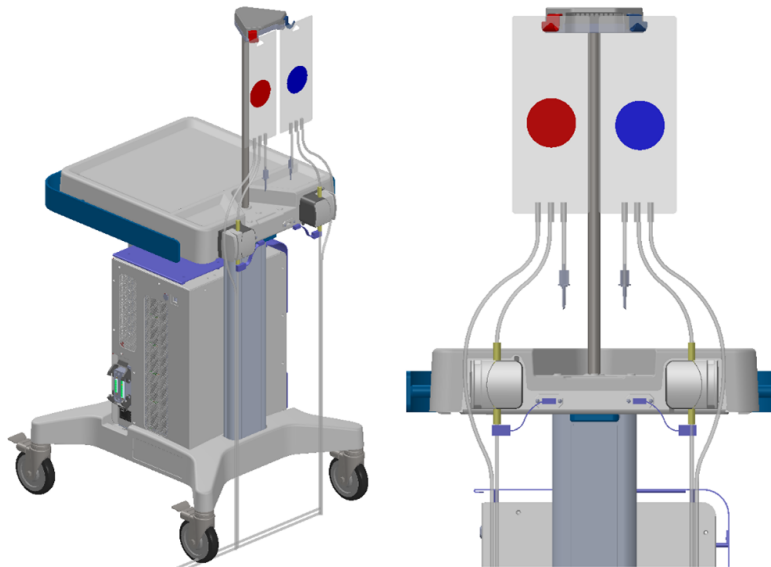

Figure 4: Preparing the system cart and fluid tube sets

5.d Powering on the System Electronics

The System Electronics enclosure is typically located in the MRI equipment room on the System Cart and close to the penetration panel holding the Filter Box. One large, black cable connects the Filter Box to the System Electronics. The System Electronics, Filter Box, and cable are installed by Profound Medical, and can remain connected when not in use.

To prepare the System Electronics for use, ensure the following connections are secure:



NOTE: If any cables are not connected, ensure they are free from damage before connecting.

1. The cable from the fluid circuit electronics, located under the cart tabletop, to the System Electronics enclosure.
2. The large black cable from the System Electronics enclosure to the Filter Box.
3. The Ethernet cable from the System Electronics enclosure to the Treatment Delivery Console (TDC) computer.
4. The System Electronics enclosure to a mains power outlet using a grounded, medical-grade power cord. Do **not** use extension cords.



NOTE: If you need to disconnect the System Electronics power cord, it is a latching connector and you must squeeze the two tabs together to remove the cord properly.

5. When all connections are established, turn the power switch on at the back of the System Electronics enclosure.

5.e Registering a Patient on the MRI Console

1. Register a new patient on the MRI console using the information obtained at the time of admission. The patient orientation must be **Head First – Supine**.
2. Load the TULSA-PRO® MRI sequence protocol.
3. If your TULSA-PRO® installation uses a TULSA-PRO® Coil Holder, it is very important to disengage the posterior coil, edit the ExamCard properties, and change the “Disengage posterior coil” from **No to Yes** (*Figure 5*).

5. Equipment Setup

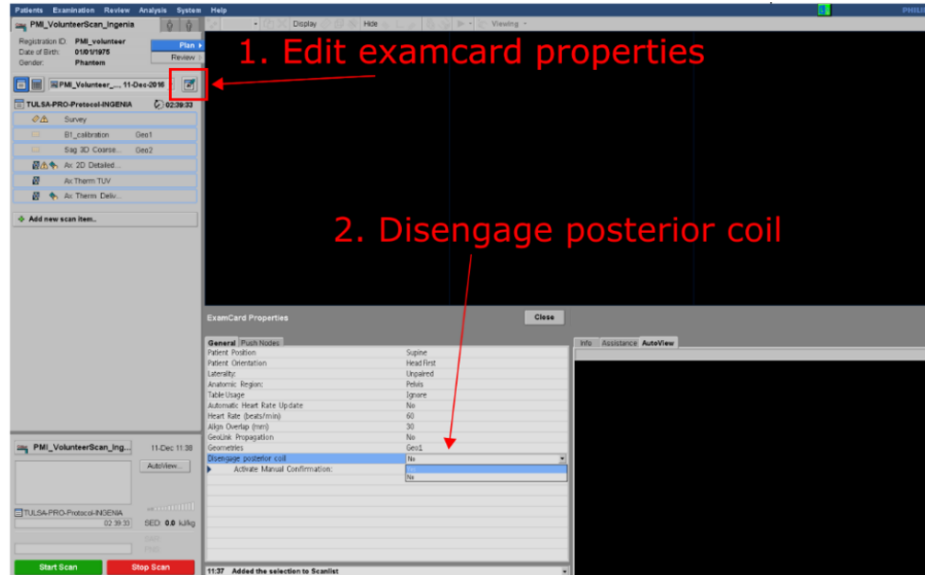

Figure 5: Setting 'Disengage posterior coil' to 'Yes'



NOTE: The patient's last name, first name, ID, date of birth, and physician name registered on the MRI console will be used to populate the TULSA-PRO Treatment Report.

5.f Preparing the Treatment Delivery Console (TDC)

5.f.i TDC Computer Setup

1. Ensure the TDC computer is placed in the control room close to the MRI console and is connected to the System Electronics and the MRI Host via Ethernet cables.
2. Power on the TDC computer and monitor.
3. Log in to Windows on the TDC computer when it powers up. Profound Medical will provide the username and password after system training has been completed.



NOTE: On any TDC screen—except during Treatment Delivery—you can press F1 on your keyboard to open and review the *TULSA-PRO® Operator's Manual*. Click **X** in the top corner to close the document window.

5.f.ii Treatment Delivery Console (TDC) Start Screen

1. Launch the TDC software from the desktop. The **Clock Sync** workspace will appear (5). To correctly recognize and accept the most recent planning images, the TULSA computer will try to connect to the MRI and automatically synchronize its clock with the MRI host computer.

5. Equipment Setup

If automatic clock sync fails, a retry option will display at the top of the screen. Check the date and time displayed on the MRI computer monitor, and if the times are more than 1 minute apart, manually adjust the date and time displayed in the TDC Clock Sync workspace.

When completed, click **Accept** to move to the **Start Screen**.



Figure 6: Clock Sync workspace

2. After synchronizing the system clocks, the **Start Screen** will appear (*Figure 7*). Click **Create New Session**.

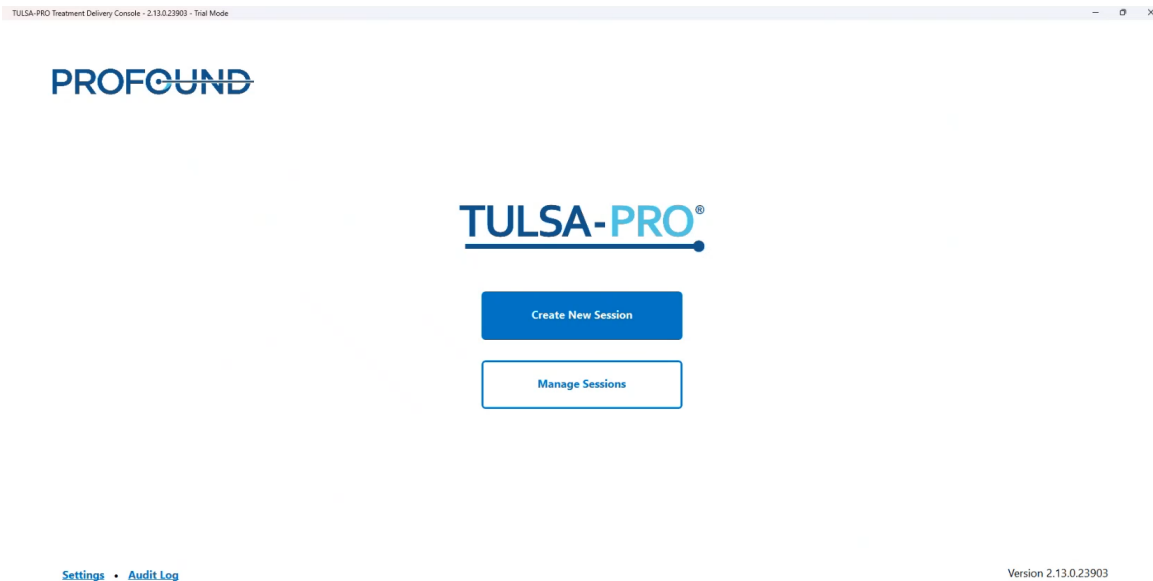

Figure 7: TULSA-PRO Start Screen

3. After selecting **New Session**, you will enter the **Setup** Workspace (*Figure 8*) where you can ensure all equipment is functioning properly before proceeding.
A green checkmark will appear in the MRI quadrant of the Setup Workspace if the TDC computer

5. Equipment Setup

and MRI host can communicate with each other, and a patient is currently open with the TULSA-PRO® MRI sequence protocol on the MRI console.



NOTE: TDC automatically locks the session 12 hours after it was started and will not allow further changes to the session.

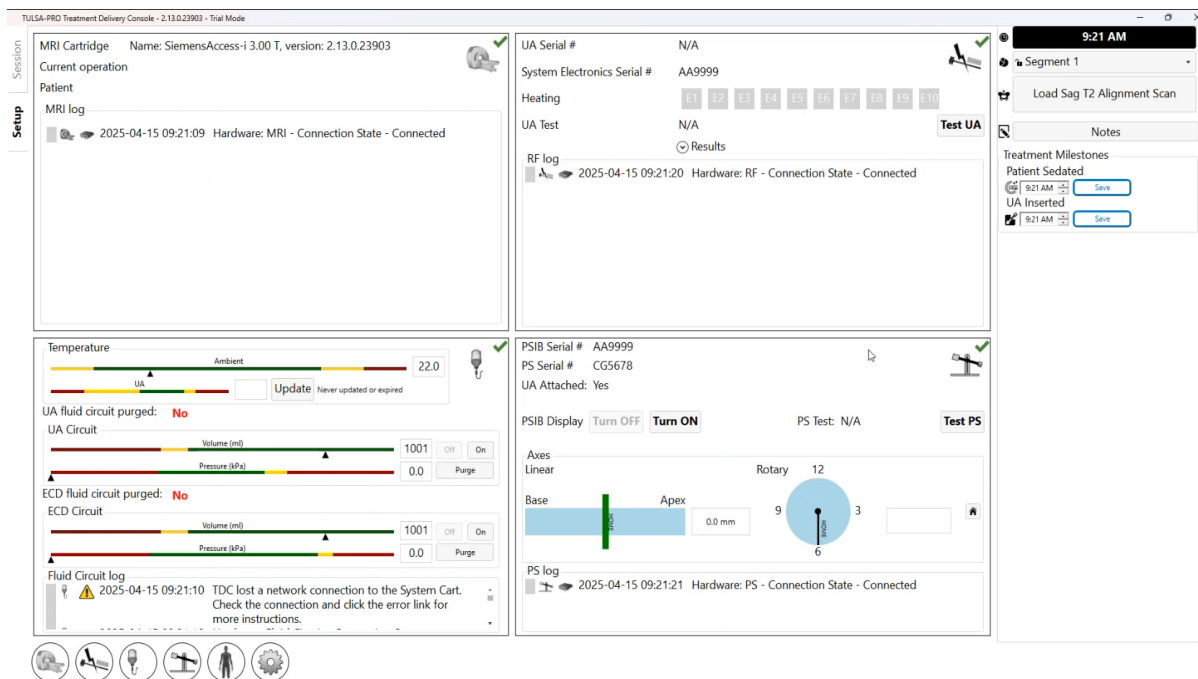



Figure 8: Setup workspace of the TDC software

3. In the Positioning System (PS) quadrant of Setup, click **Turn ON** beside **PSIB Display**.

5.g Performing Pre-treatment QA Steps

There are three QA steps to be performed in the MRI room, designated by the three tabs on the PSIB touchscreen display. These three tabs are designed to guide you through pre-treatment equipment checks to ensure that all equipment is set up correctly and functioning properly before starting patient treatment.

5.g.i PS test

- a. Check that no UA is attached to the PS. Ensure that the cable between the PS and the PS Interface Box (PSIB) does not prevent the PS from moving along its translation axis.
- b. On the PSIB display, select the PS tab  and click **Test PS** (Figure 9). The system will translate the PS forward and backward to test the continuity and functionality of the translation axis as well as home the PS in the translation axis. The system will also rotate the rotational axis clockwise and counter-clockwise to test the continuity and functionality of the rotational axis. (This

5. Equipment Setup

can also be done from the TDC *Setup* workspace in the PS information box in the bottom-right quadrant *Figure 10.*) You can move to the next step while the PS test is in progress.



NOTE: If you replace the PS after completing the PS Test, the TDC software will detect the change in equipment. Before proceeding, you must **Unlock** the Setup stage and perform the test on the new PS.

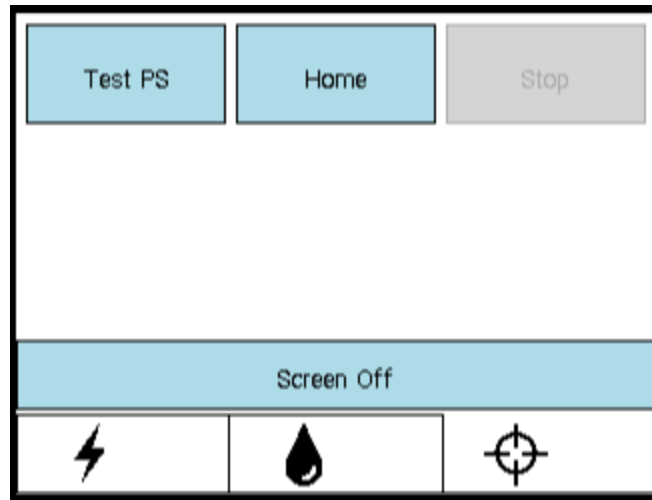

Figure 9: PSIB display - PS tab

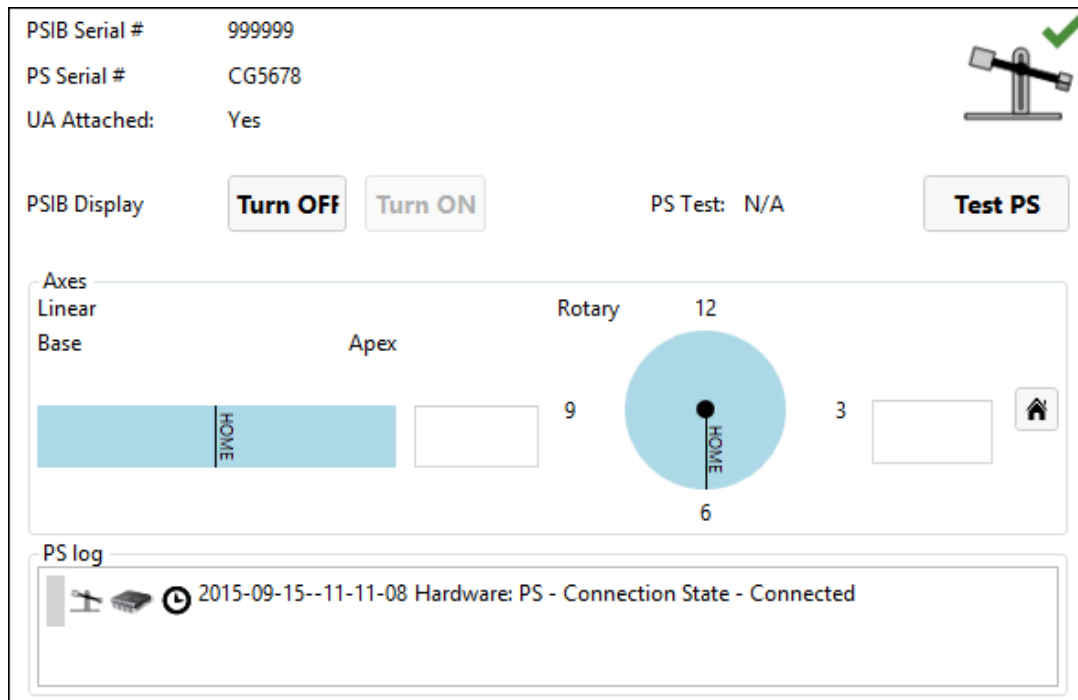

Figure 10: PS information box in Setup workspace

5.g.ii UA and ECD Preparation



The Ultrasound Applicator (UA) is fragile and should be handled with extreme care. If dropped or handled roughly, internal components could be damaged and not be obvious to the operator. Do not use a UA if you suspect any damage.



NOTE: The UA and contents inside the UA packaging **are** sterile. *Figure 11* shows the UA inside its sealed and sterile package. There is another plastic cover that encloses the UA from its tip to the top of the handle that exposes the UA cable port and guidewire inputs and fluid tubes. When you connect the fluid tubes and UA cable, the UA's sterile barrier will have to be broken. Keep the internal plastic cover over the UA during preparation to limit contamination to only the top of the UA handle.



NOTE: MRI Technologist: The ECD is *not* sterile and can be handled accordingly.

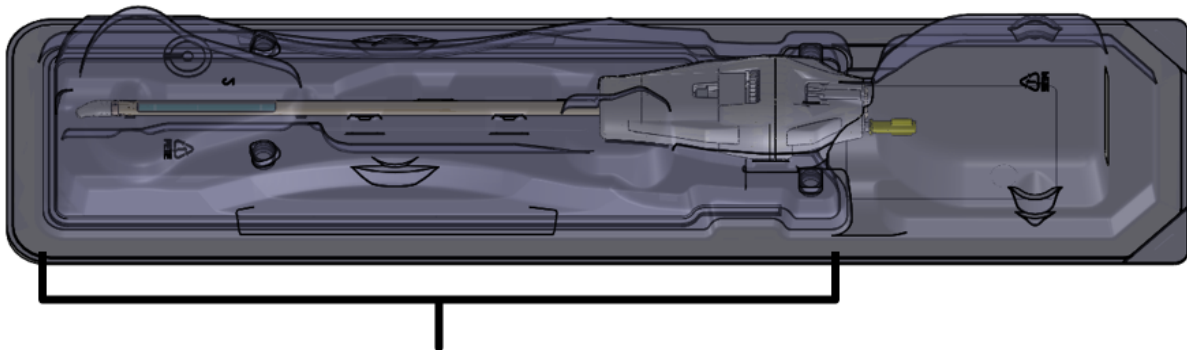

Section enclosed by an internal plastic cover.

Figure 11: UA sealed inside a sterile package

Place the UA and ECD on a clean work surface to prime with fluid from the Fluid Circuit before inserting into a patient. Follow these instructions for priming the UA and ECD:

1. ECD: Open the ECD packaging and connect the ECD tube set to the ECD matching the color-coding of the fittings (blue to blue, yellow to yellow). Undo the line clamps near the fittings. The clear line (without color coding) will be used to inflate the ECD balloon after insertion into the patient's rectum. Do not connect any fluid tubing to the light blue line at this stage of ECD preparation.



NOTE: It is not necessary to handle the ECD with sterile gloves.

2. UA: Starting from the arrows on the bottom corners of the tray label, peel off the entire Tyvek cover. Do not remove the plastic package insert; keep the UA completely in its package.
3. UA: If the physician is planning to use a guidewire, loosen the yellow cap from the back of the UA and keep for later use.



NOTE: MRI Technologist: Do not lose the yellow cap. After device insertion, the cap needs to be put back over a guidewire to stop urine from leaking from the guidewire

5. Equipment Setup

port.

4. UA: Connect the UA tube set to the UA, matching the color-coding of the fittings (red to red, white to white). Undo the line clamps near the fittings.



NOTE: In this step, it is not necessary to handle the UA packaging with sterile gloves. However, while connecting the tubeset and removing the yellow cap (if using the guidewire), avoid directly touching the UA handle **within** the packaging.

5. On the PSIB display, choose the **Fluid Circuit** tab  (Figure 12) and **Purge** the UA and ECD fluid circuits. You can also do this from the TDC by pressing **PURGE** beside the fluid circuit (FC) quadrant (Figure 13).

UA and ECD fluid circuit pressures (as shown on the TDC software interface) can fluctuate as air is purged from the UA and ECD lines. UA and ECD purging can occur concurrently. Purging lasts about two minutes.

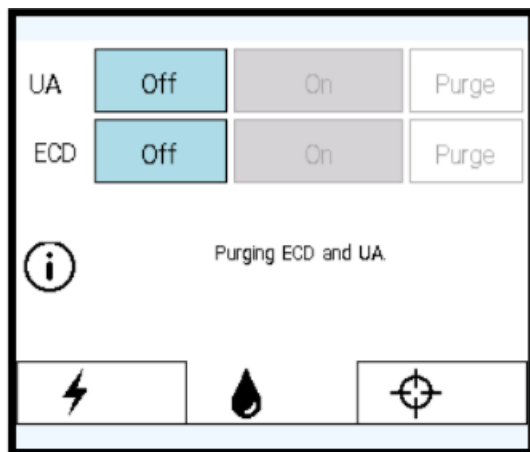

Figure 12: PSIB Display - Fluid Circuit tab

5. Equipment Setup

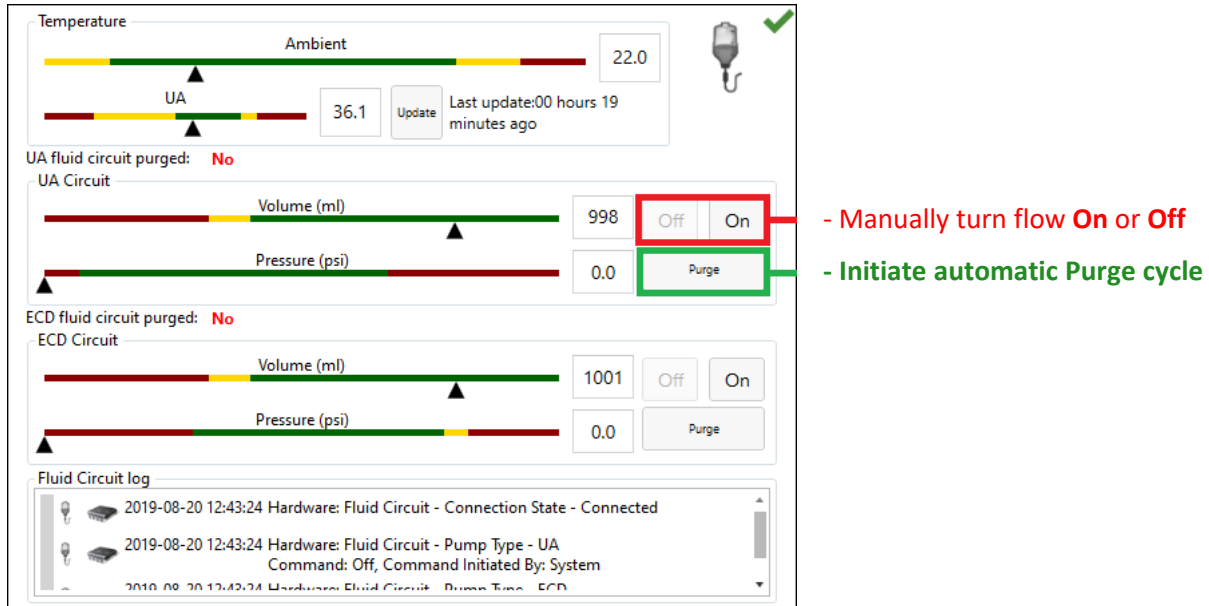

Figure 13: Fluid Circuit information box in TDC Setup workspace

5. During the two-minute device purging, check for leaks in the UA, ECD, and the entire UA and ECD tube sets.
6. Purge the ECD of all air bubbles
 - a. Holding the ECD inside its package, move it so that the cooling window faces up. Bubbles should dissipate in 90 seconds from the moment you clicked **Purge**. You can also lightly tap the package to dislodge any remaining bubbles. There should be no visible bubbles in the cooling window when purged correctly.
 - b. Inspect the entire ECD and ECD tube set for leaks. If you find a leak in the tubes, replace the tube set. If you find a leak in the ECD, replace the ECD. If you replace the tube set or ECD, return to [step 1](#) in this section and repeat the procedure.
 - c. Place and secure the ECD on the work surface until ready to be inserted into the patient.



If for any reason the ECD tube set is detached after initial fill and purge, you must purge the ECD of bubbles again.

7. Purge the UA of all air bubbles.
 - a. If the purging cycle ends before completing the steps in this process, return to the PSIB display (or TDC window) and manually turn the flow on by clicking **On**. The fluid pumps will remain on until you click **Off** (Figure 13).
 - b. While the purging operation is on, hold the UA in its package—to keep the UA sterile, be careful not to touch the UA handle. Tip the package upwards in the 0° position, then tilt to approximately 45°, then 90°, and 135°. At each angle, slowly rotate the package approximately 360° and tap continuously along the packaging to dislodge any bubbles in the handle and shaft (Figure 14).

5. Equipment Setup

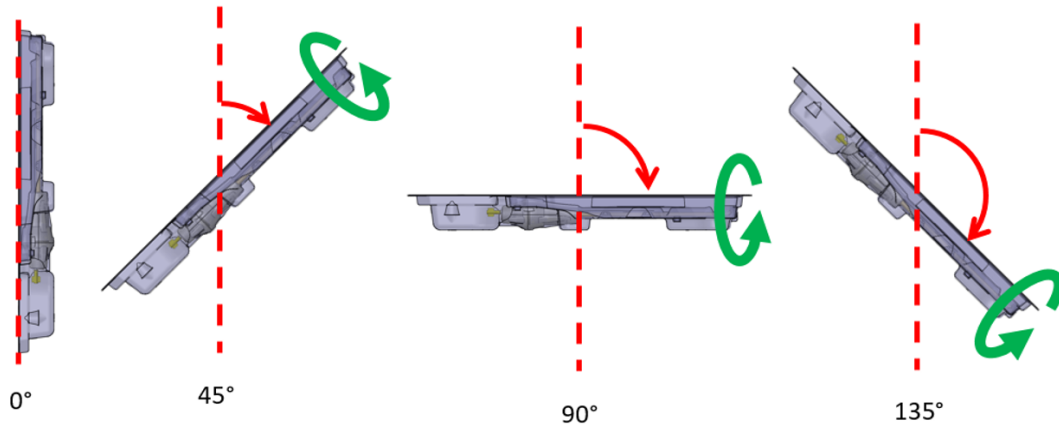

Figure 14: Recommended procedure for purging air from ultrasound applicator

- c. Rotate the UA package so that the flat side is facing down. Inspect the UA closely through the plastic package and ensure there are no signs of water in the package, which would indicate a leak. If you see any signs of leaking water, the UA is defective and should not be used. Use a new UA and repeat the UA preparation procedure.
- d. When the purge cycle is complete, look through the package and carefully inspect the UA window for bubbles while raising and lowering the tip of the UA (Figure 15). There should be **no** bubbles of **any** size. If you see bubbles, turn on the pump and gently tap the package-end close to the UA window to dislodge them. If you still see bubbles, repeat this step until all bubbles have been eliminated.



NOTE: The pumps must be turned off to inspect for bubbles. Similarly, the pumps must be turned on for the flow to dislodge any bubbles.

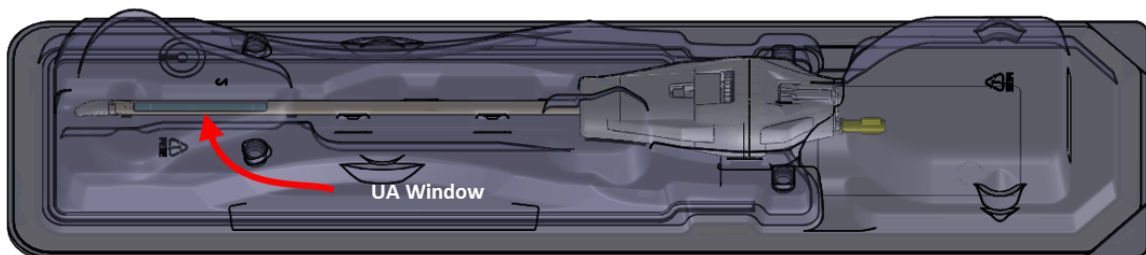

Figure 15: Examine the UA window for air bubbles

- e. Secure the UA package (open side up) on the work surface. While avoiding contact with the UA handle, connect the UA cable from the PSIB to the UA by rotating the UA cable until the connector's keyed-slot lines up with the UA port.



If for any reason the UA tube set is detached after initial fill and purge, you must purge the UA of bubbles again.

Once the UA and ECD have been purged of all air bubbles and are ready for insertion in the patient, proceed to the next step,

5.g.iii RF connectivity test

1. Ensure the UA is connected to the UA tube set and purged of air (see *Purge the UA of all air bubbles.*).
2. Without removing the UA from its package, ensure the UA cable is connected from the PSIB to the back of the UA. Care should be taken to avoid contaminating the UA handle.
3. In the **RF** tab ⚡ of the PSIB display, click **Test UA** (Figure 16).
The system will send a short burst of power to each of the ten UA elements to ensure continuity and functionality of all ten channels. This can also be done from the TDC Setup workspace from the RF information box in the top-right quadrant (Figure 17).
When the RF connectivity test is complete, the PSIB will display a short message (Figure 16). You can see detailed RF connectivity test results in the RF information box of the TDC software (Figure 17).
4. Turn both pumps back on and disconnect cables from UA and PS to prepare for moving equipment to the MRI table.



NOTE: If you replace the UA after completing the RF connectivity test, the TDC software will detect the change in equipment. Before proceeding, you must **Unlock** the Setup stage and perform the test on the new UA.

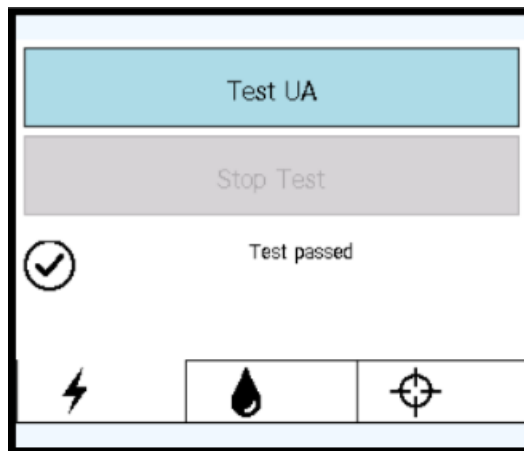

Figure 16: RF tab on PSIB display after successful RF connectivity test

5. Equipment Setup

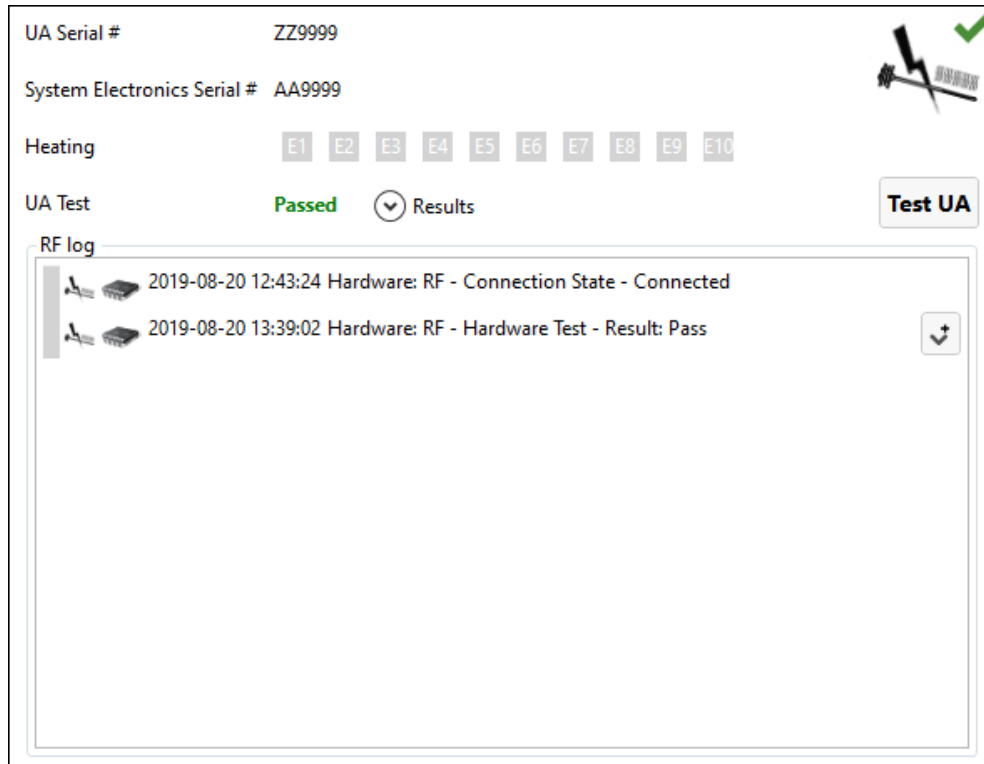

Figure 17: RF information box in Setup workspace after successful RF connectivity test

5.g.iv Preparing ECD Lubricant Channels

If using an ECD with green and black lubricant channels, follow these steps to prime the channels with low-viscosity lubricant:



NOTE: Ensure that the ECD fluid circuit (blue and yellow channels) has been purged and checked for leaks (on page 26) before priming the lubricant channels (green and black) for bubble removal.

1. Connect a three-way stopcock and the syringe adapter to both the green and black-labeled channels (*Figure 18*).
2. Connect low-viscosity lubricant syringes to the syringe adapters by pressing the taper on the syringe into the syringe adapter tubing (*Figure 18*).



NOTE: To avoid creating air bubbles at the ECD surface, ensure there is no air in the lubricant syringe before connecting to the green and black channels. It is recommended you store lubricant syringes vertically with the tip pointing upwards to allow air to escape before the day of treatment.

5. Equipment Setup

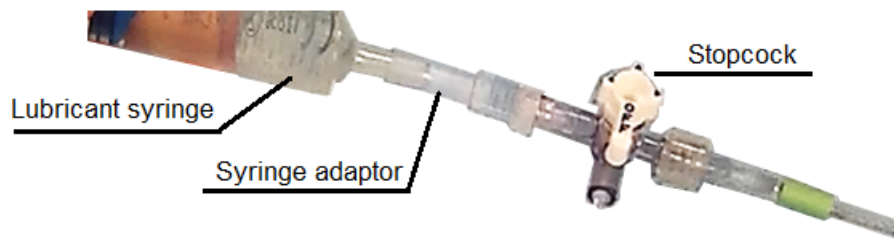

Figure 18: Lubricant syringe with adaptor and stopcock

3. After attaching the syringe, remove air from the line by pushing a small amount of gel and any air out through the side-port of the stopcock.
4. Prime the lubricant injection and removal channels.
 - a. Slowly inject approximately 15 ml of low-viscosity lubricant into the green channel, which will later be used to extract air from the ECD surface. Gently press on the pores closest to the handle to allow lubricant to fill the small pores at the tip of the ECD. Use the stopcock to restrict and expel air when switching lubricant syringes.

Ensure that lubricant emerges from all the small pores from the handle to the tip of the ECD.
 - b. Slowly inject approximately 10 ml of low-viscosity lubricant into the black channel, which will add lubricant to the ECD surface. Gently press on the pores closest to the handle to allow lubricant to fill the large pores at the tip of the ECD. Continue pushing until no bubbles emerge from the top pore. Ensure that some lubricant emerges from all the large pores from the handle to the tip of the ECD (Figure 19).



Figure 19: Lubricant emerging from ECD pores

- c. On the injection (black) channel, connect a new, full syringe of low-viscosity lubricant. The extraction (green) channel will be used for suction, so leave an empty 30ml syringe attached. Visually inspect the pores of the device to ensure all are filled. If not, push additional gel through the respective gel line. Ensure that both stock cocks are locked towards the gel lines to prevent air from penetrating into the gel-filled pores.



IMPORTANT: Only use the provided low-viscosity lubricant in the bubble removal channels. Other lubricants and ultrasound gel can cause additional air bubbles in

the rectum.

6. Initial Patient Positioning

Initial patient positioning involves transferring the patient to the already-prepared MRI table, positioning them correctly over the imaging coil, securing them using the leg rests and appropriate straps, and establishing MRI anesthesia and patient monitoring.

This step is led by the MRI Technologist, with specific assistance from the Anesthesiologist, and physical assistance in safely moving the patient from all members of the clinical team.

MRI Technologist:

1. Transfer the patient into the MRI magnet room using an MR-compatible gurney or by undocking the MRI bed.



When transporting the patient into the MRI magnet room, if a guidewire is already placed, make sure it is secured to the patient.

2. Position the patient on the MRI bed in a head-first supine position so that their sagittal midline is centered from left to right on the MRI table, and their prostate is centered within the treatable area (*Figure 20 [Your configuration might not match exactly as shown]*).

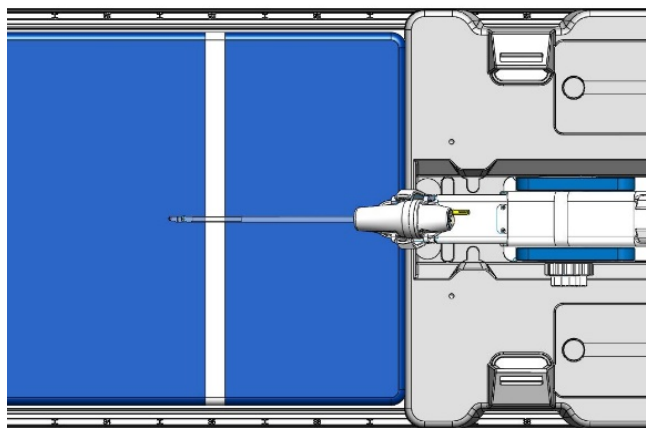

Figure 20: Centering and aligning the coils with the prostate

4. Have an assistant lift the patient's legs one at a time while you set up the leg supports (*Figure 21*):
 - a. Place the leg supports into the designated slots of the base plate with the foam on the outside of the patient's legs for support.
 - b. Support the patient's legs and adjust the positions of the leg supports along the slots in the base plate. Insert two leg straps for each leg support by looping the straps through the leg support slots, with the label side up.
 - c. Wrap each leg support strap around the patient's leg, through the plastic ring at the end of the strap and then fasten back on itself.
5. Provide the patient with ear protection to protect against MRI-related hearing injury, even though the patient might be under general anesthetic.

6. Initial Patient Positioning

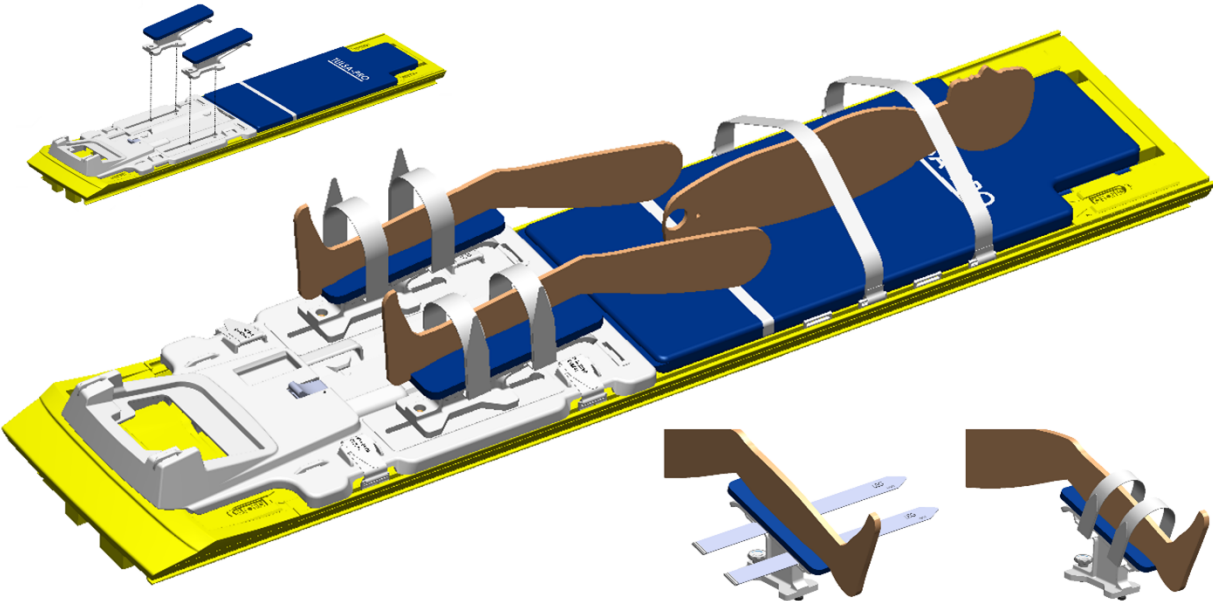

Figure 21: Initial patient positioning and attachment of leg supports

7. Device Insertion

The **Urologist** inserts the Ultrasound Applicator (UA) and the Endorectal Cooling Device (ECD) into the patient, with assistance from the **MRI Technologist**.

7.a Inserting the ECD

Urologist: Insert the Endorectal Cooling Device (ECD), with assistance from the **MRI Technologist** who passes the ECD, lubricant, and saline syringes to the **Urologist**.

7.a.i To insert the ECD the first time:

1. **Urologist:** Apply 5-10 ml of low-viscosity lubricant to your glove and wipe the anterior rectal surface.
2. **Urologist:** Apply 10-15 ml of the same lubricant to the ECD. Ensure lubrication covers the cooling window on the anterior surface of the ECD.
3. **Urologist:** With fluid tubing attached, insert the ECD with a twisting motion, starting with the ECD window facing 9:00 and rotating clockwise to 12:00, while also applying upward pressure against the anterior rectal wall. Insert the ECD as far as possible until you feel resistance.
4. **Urologist:** Ensure the tactile ridge on the ECD handle facing anteriorly.
5. **Urologist:** After you confirm alignment, inflate the ECD balloon with 15-20 ml of saline to maintain upward pressure against the anterior rectal wall. Be prepared to fill the balloon up to the maximum capacity as stated on the label on the ECD body (*Figure 22*) or until the ECD is securely positioned in the rectum. It is important that the ECD remains stationary at the correct insertion depth during MR imaging and treatment.



Figure 22: Sample ECD labels with maximum saline capacity

6. Position the ECD suction lines to the opposite side of the base plate away from the cooling tube-sets and secure using a strap. Apply suction to the green line of the tube set by opening the channel to the syringe and applying tension until the flow stops. While maintaining suction on the syringe, close the stop cock towards the tubing to prevent the air and gel from being pulled back to the surface of the device.



Over-filling the balloon while inserted in the anal passage or rectum can cause stretching and possible trauma, especially if left overfilled for a long time. Also, over-filling the balloon to the point of breaking can cause trauma to the tissue.

If you under-fill the balloon, you risk having the ECD slide out during treatment,

which would cause inadequate cooling of the rectal wall and lead to unintended thermal damage to the rectum and possibly to fistula.

7.b Preparing the UA

Before inserting the Ultrasound Applicator (UA), do a final check for bubbles or leaks.

1. **MRI Technologist:** Ensure the UA cable is disconnected from the UA and connected to the PSIB.
2. **MRI Technologist:** Without touching the UA to maintain sterility, detach the yellow cap (storing for later use). Remove the plastic cover enclosing the UA in the package.
3. **MRI Technologist:** While holding the UA packaging tray by the long edges of its perimeter, flex the tray to release the UA from its snap features (*Figure 23*).
4. **Urologist:** Using one sterile, gloved hand, remove the UA from the package by gripping the end with the white plastic handle.

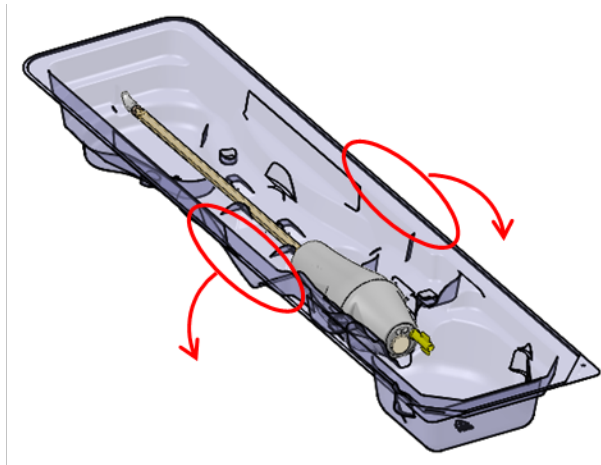

Figure 23: Releasing the UA from the packaging tray



To keep the UA sterile, *only* handle the packaging tray by its edges.

7. **Urologist:** Closely inspect the UA along the length of the shaft for any water leakage, paying attention to the areas of interest shown in *Figure 24*. If you see water, the UA is defective and must not be used.

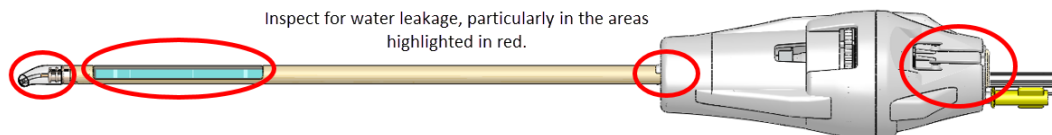

Figure 24: Areas to inspect for water leaks in the UA

8. **Urologist:** Closely inspect the UA window for bubbles of any size. If you see bubbles, using a sterile gloved finger, gently tap next to the UA window to dislodge the bubbles. Do not insert

7. Device Insertion

the device until you see no bubbles.

7.c Inserting the UA

1. **MRI Technologist:** Open sterile lubricant and present to the **Urologist**, as needed.
2. **Urologist:** Apply sterile lubricant directly into the urethra and onto the acoustic window of the UA, taking care to provide clear acoustic coupling by filling the urethra without creating bubbles.
3. **Urologist:** Wearing sterile gloves, thread the guidewire through the tip of the UA and insert the UA over the guidewire and into the prostate. Ensure the tip of the UA has entered the bladder.
4. **Urologist:** Remove the guidewire, leaving the UA in place.
5. **MRI Technologist:** Replace the yellow cap on the hub of the guidewire channel at the back of the UA handle.



Ensure the guidewire is removed before imaging the patient with the MRI. The guidewire has not been tested to ensure patient safety during MR imaging.

7.d Docking the Ultrasound Applicator to the Positioning System



This procedure requires two operators: one to hold the UA at a natural angle and one to move the PS into place. Attempting this procedure with only one operator can physically injure the patient.

1. **Urologist:** Hold the UA handle with the UA positioned at a natural angle in the patient, while the **MRI Technologist** installs and adjusts the PS to capture the UA in the PS gripper.
2. **MRI Technologist:** Ensure that the slot for the PSIB is clear. Place the PS and PSIB in their respective slots on the base plate. Secure the Positioning System (PS) to its slot on the base plate between the patient's legs by snapping it into the latch (*Figure 25*).

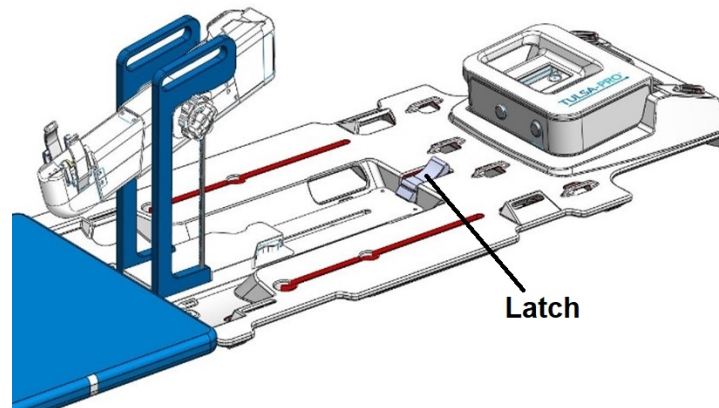

Figure 25: Secure the Positioning System using the latch on the base plate

3. **MRI Technologist:** Manually move the PS into position so that the UA gripper aligns with the natural angle of the UA in the patient. Manually adjust the PS forward and backward, up and down, and left to right, and tilt the linear axis of the PS up and down (*Figure 26*).

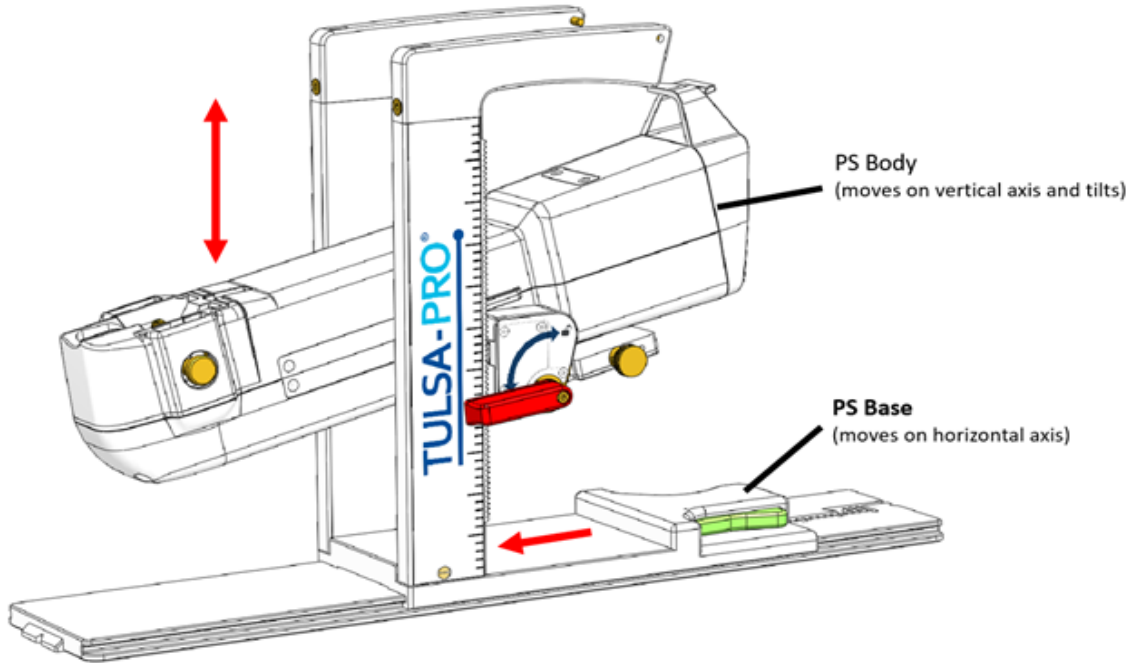

Figure 26: Adjusting the Positioning System



NOTE: The PS adjustment knobs and levers are not colored as in *Figure 26*, but are colored here to help with these instructions.

- a. Adjust the horizontal position of the PS base by pressing the lever (**green**) and slide the PS base into position. Release the lever to lock it in place.
- b. Adjust both the vertical and tilt positions of the PS body by turning the outer lever (**red**) clockwise to unlock. Turn the outer lever (**red**) counter-clockwise to lock.
- c. Adjust the lateral movement of the PS body by turning the brass turn knobs located at the bottom rear of the PS (**gold**).



NOTE: Only adjust the forward and backward location of the PS at its base and ensure that the adjustment-release lock is fully disengaged before moving.

4. **MRI Technologist:** After locking the PS tilt and height, seat the UA in the PS nose and then secure it by pressing the UA clamp down over top of the UA until it is fully engaged with the PS nose. (*Figure 27*).



NOTE: You will hear an audible click when the clamp is fully inserted into the PS nose.

7. Device Insertion

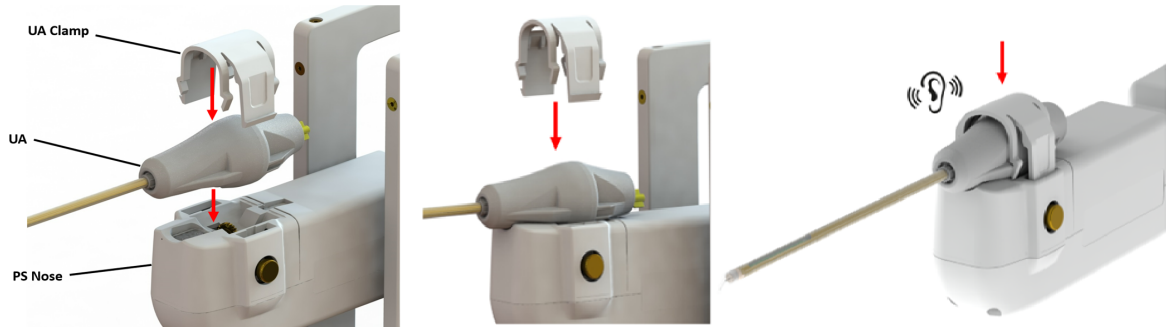

Figure 27: UA attachment to Positioning System

5. Ensure that the UA is not being 'forced' into position. If so, release the UA from the UA gripper and adjust the PS axes to achieve better alignment with the UA. Ensure the height and tilt-release knobs on the PS are locked before securing the UA in the gripper of the PS.
6. **MRI Technologist:** Thread the UA cable and UA tube set through the cable management arms on the top of the PS with minimal tangling or twisting of the cables. Ensure the UA tube line-clamps are not tangled with the cable management arms of the PS. Connect the UA cable to the back of the UA and the PS cable to the back of the PS. These connectors are keyed and will only fit in one orientation. If the UA cable has a large block along its length, place the block securely in its recess on the base plate near the PSIB. Ensure that the UA and PS cables do not prevent the PS from moving along its translation axis.

8. MRI Patient Positioning

After transferring the patient to the MRI table and inserting the Ultrasound Applicator (UA) and Endorectal Cooling Device (ECD), the MRI Technologist places restraint straps around the patient to prevent motion of the pelvis during MR imaging, positions the anterior imaging coil, and checks that the devices are ready for imaging. The Anesthesiologist does a final check.

8.a Securing the Patient

1. MRI Technologist: Fasten one abdomen arm-strap tightly over the lower abdomen under the patient's arms to minimize anterior-posterior breathing motion. Wrap the sheet over the abdomen and place the patient's hands on top. Fasten a second abdomen-arm strap over the arms to help fit the patient into the MRI bore (*Figure 28*, your configuration might not match exactly as shown).

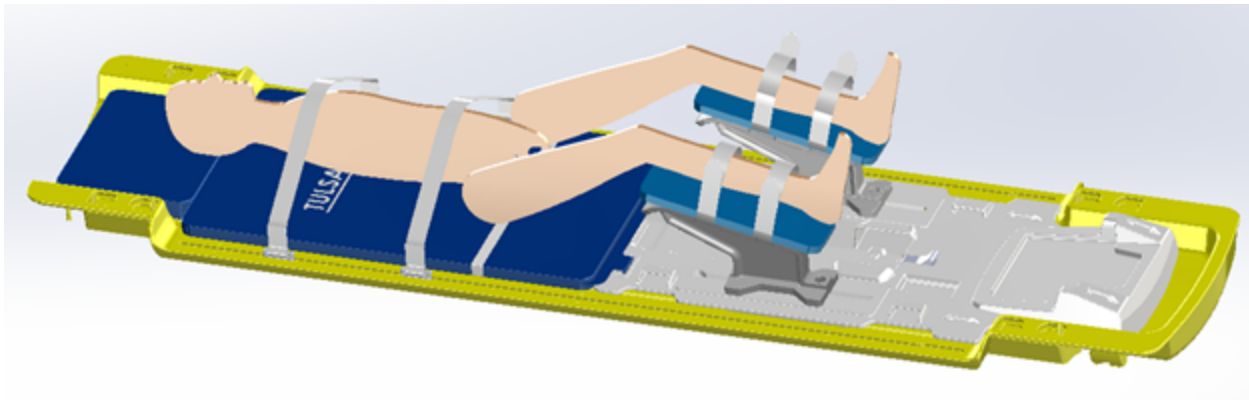

Figure 28: Securing the abdomen and arm straps

2. MRI Technologist: For the patient's comfort, use sheets to keep them warm and pads to avoid pressure points. Also, to avoid electrical burns, ensure that the patient's skin is not directly touching the coils or MRI bore.
3. MRI Technologist: Strap the anterior imaging coil over the patient's pelvis and arms. The coil should cover the prostate, without interfering with the travel of the Positioning System (*Figure 29*).

8. MRI Patient Positioning

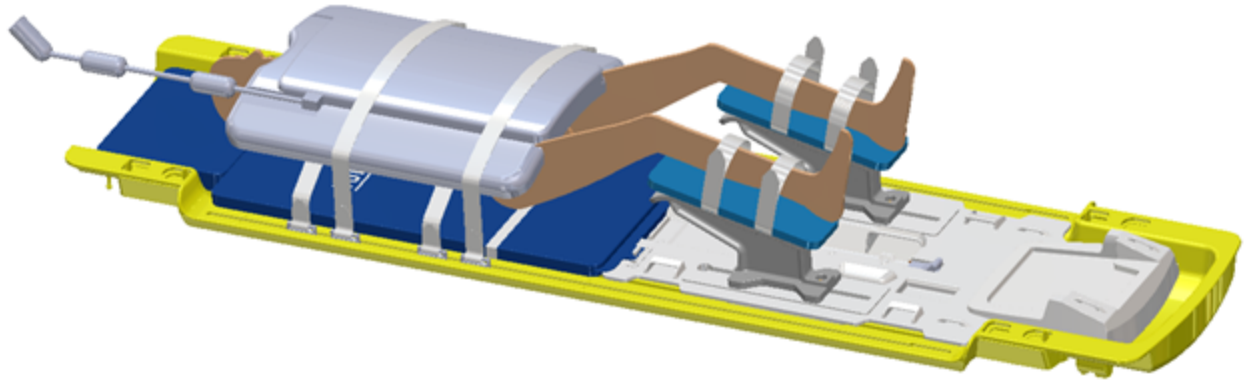

Figure 29: Placement of the anterior imaging coil

4. MRI Technologist: Use tube-and-cable straps to manage fluid tubes and the white RF cable as shown in *Figure 30*. Leave some slack to allow the cables to slide freely and to reduce tripping hazards. Ensure no cables, tubing, or other materials can be caught while the MRI table is moving.

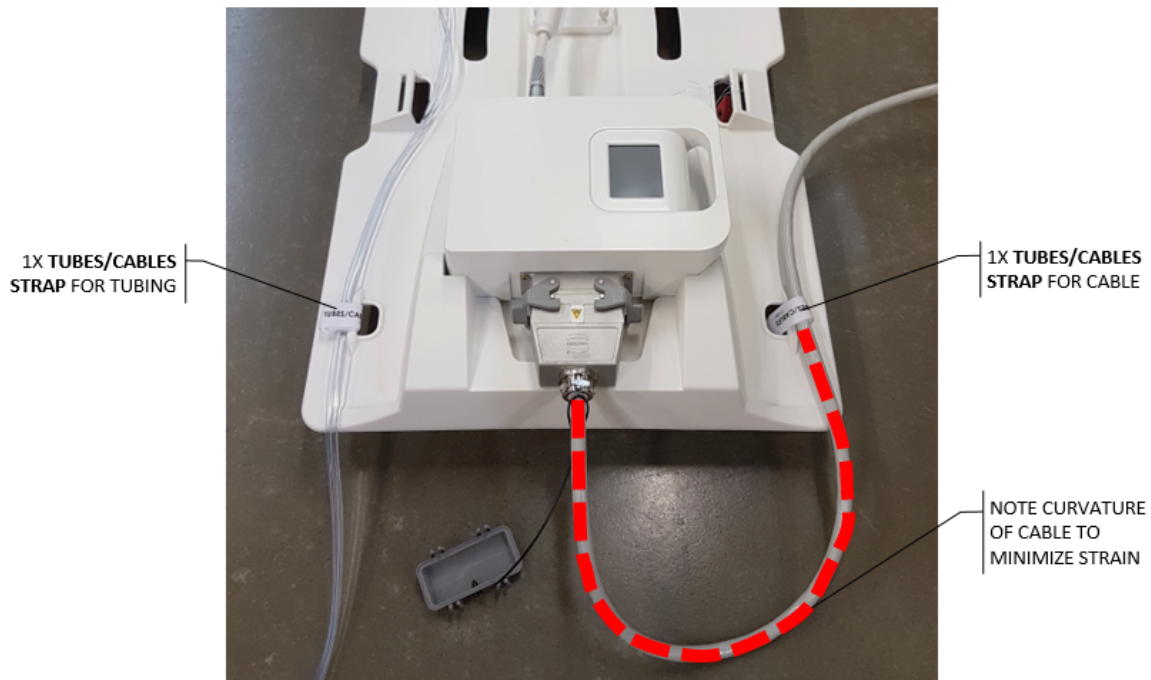

Figure 30: Tube-and-cable straps of base plate: one for tube sets and one for RF cable

5. Anesthesiologist: Check that IV, gas, and monitoring lines are providing reliable readings and routed appropriately along the MRI table. Check that none of the straps are applying excessive pressure to the patient's skin or joints. If using a supra-pubic catheter, ensure that the urine collection bag is secured and unobstructed.

8. MRI Patient Positioning

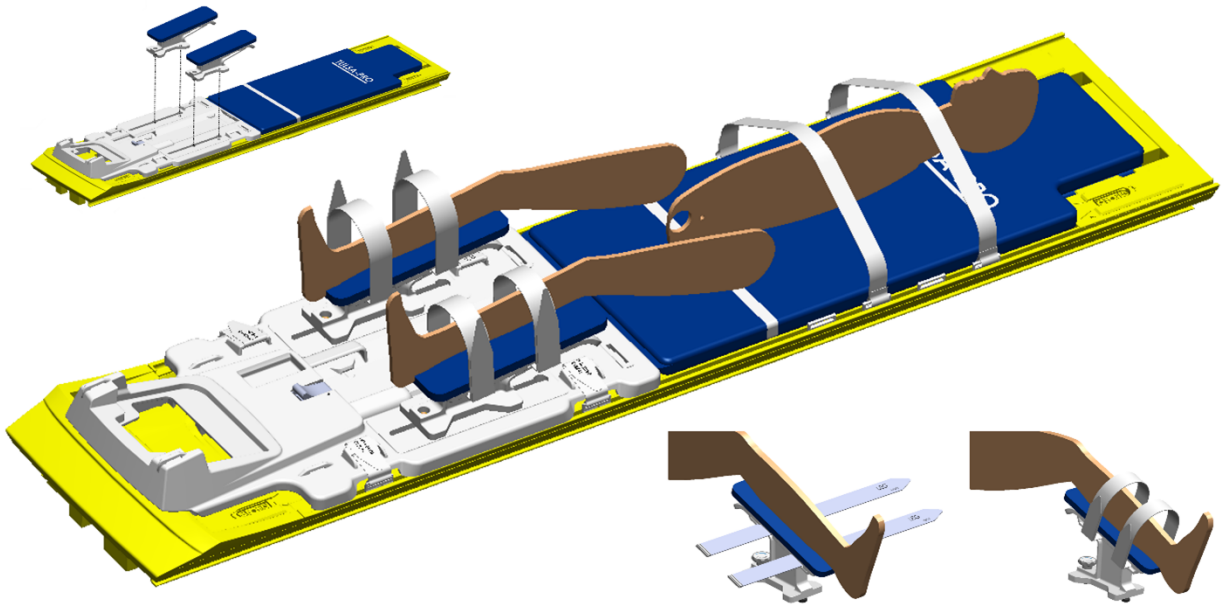



Figure 31: Patient positioning is complete

8.b Device Check

With the patient ready for imaging and treatment, the MRI Technologist homes the rotation of the ultrasound applicator, verifies that flow to the UA and ECD is off, and turns off the PSIB screen.

1. MRI Technologist: In the **PS** tab () of the PSIB display, click **Home** ().
The system will rotate the UA clockwise and counter-clockwise to find the home position of the UA, so the UA window is facing downwards (6:00).
2. MRI Technologist: Confirm that rotational homing completes successfully. The PSIB display will turn off automatically if homing is successful.

9. Treatment Planning

9.a Initial Imaging

With the patient positioned for imaging, the MRI Technologist can follow these instructions to set the landmark position and acquire localizer images using the TULSA-PRO® MRI sequence protocol.

9.a.i MRI sequence protocol and instructions

	SCAN NAME	PURPOSE	TDC STEP
1	Localizer	Initial scan used to confirm initial device positioning	Initial Imaging
2	SAG T1	Bubble detection	Initial Imaging
3	SAG T2	Scan used for UA alignment and UA linear position adjustments	Alignment and Coarse Planning
4	SAG SWI	Susceptibility weighted imaging scan for calcification detection	Coarse Planning
5	AX THERM	Temperature uncertainty and Treatment Delivery	Detailed Planning and Delivery
6	AX T2	Anatomical T2-weighted scan for contouring the prostate	Detailed Planning
7	AX DWI	Diffusion weighted imaging scan for contouring the prostate	Detailed Planning
8	AX T1	Post-treatment scan acquired before and after administering IV contrast	Review



Before starting, make sure that the Table Usage property in the ExamCard properties is set to Ignore.

1. Before inserting the patient into the bore, ensure the posterior coil is disengaged in the current ExamCard.
2. Align the laser scope with the prostate and anterior MR imaging coil. Set the landmark position on the MRI.
3. Slowly advance the MRI table for scanning, taking care to avoid pinching tubes and cables, pressure on the patient's skin, and direct contact of the patient's skin with the coils or MRI bore.
4. At the MRI console, check that the appropriate anterior and posterior coils are connected, and then run the **Localizer** scan.

9.a.ii Entering Treatment Milestones

MRI Technologist: After homing is complete, the icons in the Treatment Milestones section on the right side of the TDC *Setup* workspace will pulse to remind you to enter some data. While initial imaging is being performed, enter the time when the Anesthesiologist finished sedating the patient and the time when the **Urologist** inserted the UA. Recording these times will allow for better estimates of total procedure and anesthesia duration.

To record these times in TDC:

1. In the TDC *Setup* Workspace, enter the sedation and UA insertion times under **Treatment Milestones** (Figure 32).
2. Click **Save**. The Treatment Milestones area will turn gray and the Save button will be replaced by Edit.

You can also enter these times after treatment is completed and the report is generated.

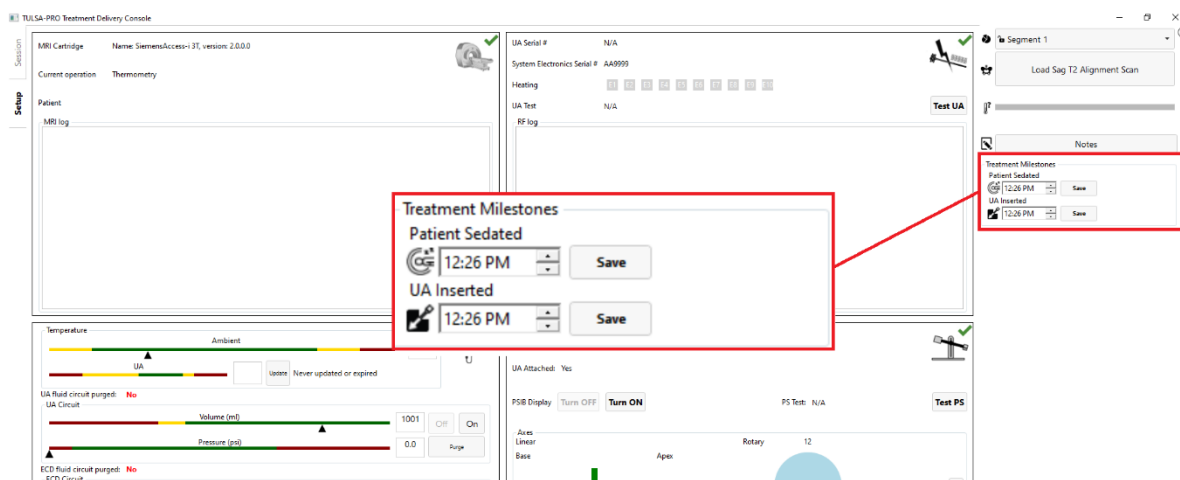

Figure 32: Entering Treatment Milestones in the TDC Setup Workspace

9.b Checking Gross Device Positioning

The **Radiologist** determines the initial positions of the UA in the prostate and ECD in the rectum, using the Localizer images, and optional fast 2D sagittal T2-weighted or T1-weighted scans. Inserting the UA and ECD can significantly deform the shape of the urethra and prostate. If necessary, the **Urologist**, with help from the **MRI Technologist**, manually adjusts the device positions to eliminate air bubbles in or around the UA and ECD on the MR images.

9.b.i Reviewing initial device positioning

1. **Radiologist:** Check that the ultrasound applicator (UA) is inserted correctly:
 - a. The UA should pass within the prostatic urethra into the bladder and the active elements of the UA should be near enough to the intended treatment volume that the positioning system can be used for fine adjustment. Specifically, any required adjustment should be

9. Treatment Planning

within the maximum automated linear movement of the PS in either direction (39 mm in either direction, 32 mm for some models). If a larger adjustment is required, adjust the insertion depth of the UA manually.

- b. The radius from the center of the UA to the edge of the prostate should be within the 30 mm maximum expected treatment depth of the center of the applicator. If the radius is beyond this depth, adjust the insertion angle of the UA manually.
2. Radiologist: To check for air bubbles in the rectum that can interfere with imaging or ultrasound delivery, scroll through all axial and sagittal images that intersect the UA window, paying special attention to the ECD notch region. There should be no bubbles within the ECD or between the ECD and the rectal wall adjacent to the prostate (in the ultrasound path). To confirm that the ECD is placed correctly:
 - a. The cooling window should cover the prostate and expected range of ultrasound energy from the UA, as confirmed on the sagittal MRI (*Figure 33*).

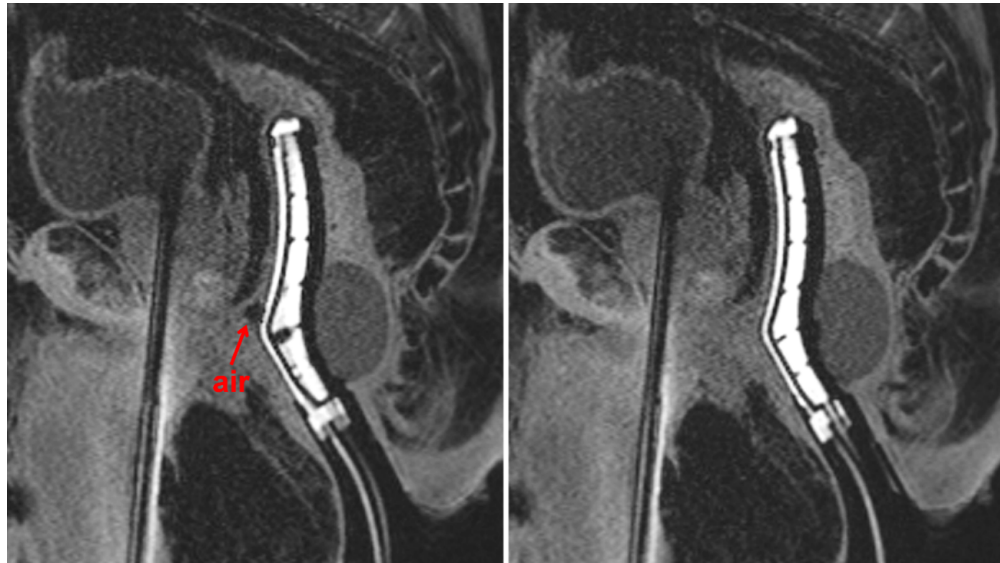

Figure 33: Sagittal images of ECD facing anteriorly towards the prostate, with air in the beam path (left) and correctly adjusted to eliminate air from the beam path (right)

- b. The orientation of the cooling window should face the prostate (anterior), as confirmed on the axial MRI (*Figure 34*). Check that the ECD cooling window is adjacent to and facing the prostate, with the handle-neck joint of the ECD at the anal verge and the raised, tactile ridge on the ECD handle facing anteriorly.

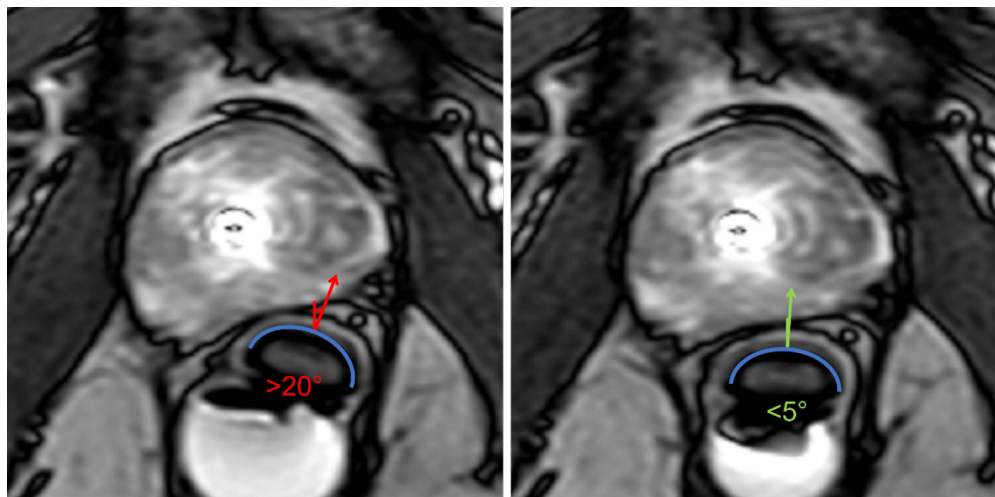

Figure 34: Axial images depicting ECD oriented incorrectly (left, rotated more than 20 degrees) and correctly (right, facing up towards the prostate)

9.b.ii Adjusting device positioning

1. **If the UA positioning is incorrect:** Adjust the UA insertion depth or angle manually and then re-acquire another scan to confirm the correct positioning:
 - a. **MRI Technologist:** Move the MRI patient table out of the bore far enough for the Urologist to adjust the UA.
 - b. **Urologist:** With clean gloves, hold the UA handle as the MRI Technologist detaches the UA from the PS and unlocks the PS body.
 - c. **Urologist:** Adjust manually the UA insertion depth, angulation, or both.
 - d. **MRI Technologist:** Adjust the location and angulation of the PS body to match the desired UA positioning and captures the UA handle in the UA clamp of the PS.
 - e. **MRI Technologist:** Advance the MRI patient table and re-acquires a Localizer or fast 2D sagittal T2 or T1 sequence to verify the changes to device positioning.
2. **If the ECD placement is not ideal:** Manually adjust the ECD position in the rectum, use the ECD bubble removal channels, or both. Then re-scan to confirm ideal positioning:
 - a. **MRI Technologist:** Move the MRI patient table out of the bore far enough for the Urologist to adjust the ECD.
 - b. **Urologist:** Adjust the ECD position in the rectum manually so that the cooling window is facing and adjacent to the prostate and covers the expected range of ultrasound energy from the UA, and to eliminate air in the rectum lateral to the ECD.
To move the ECD closer to the prostate or move bubbles out of the ultrasound path, inflate the ECD balloon with water or saline gradually in 5-10 mL increments, up to a maximum volume of 30 mL.
 - c. **Urologist:** If using an ECD with green and black lubricant channels, remove small air bubbles from the lubricant anterior to the ECD by applying suction to the syringe on the extraction (green) channel, drawing air out from the ECD surface until all large bubbles (greater than 1 cm) are removed from the ECD tubing. Remove air gaps between the

9. Treatment Planning

lubricant and the rectal wall by applying approximately 3 ml of low-viscosity lubricant into the injection (black) channel of the ECD tubing.

- d. **MRI Technologist:** Advance the MRI patient table and re-acquire a Localizer or fast 2D sagittal T2 or T1 sequence to verify changes to device positioning.
3. If you see air on gross positioning images between the **anterior** surface of the ECD and the rectal wall, remove it by applying a combination of suction to the extraction (green) channel and additional lubricant through the injection (black) channel:
 - a. **Urologist:** If there are small bubbles in the lubricant anterior to the ECD, apply suction to the syringe on the extraction (green) channel, drawing air out from the ECD surface until you remove all large bubbles (greater than 1 cm) from the ECD tubing.
 - b. **Urologist:** If there is an air gap between the lubricant and the anterior rectal wall, apply approximately 3 ml of additional lubricant to the injection (black) channel.
 - c. Acquire another gross positioning image. If bubbles persist, repeat these steps.
4. If there are air bubbles on gross positioning images **lateral** to the ECD within the rectum and not on the anterior surface, follow these steps:
 - a. **MRI Technologist:** Temporarily remove 5-10 ml from the ECD saline balloon.
 - b. **Urologist:** Rotate the ECD left and right while consistently applying upward force.
 - c. **MRI Technologist:** With the ECD cooling window correctly aligned, re-inflate the balloon with 10-15 ml (ideally, 5 ml more fluid than for the first insertion), ensuring that the ECD remains securely positioned in the rectum at the correct insertion depth.

Once the **Radiologist** is satisfied with the gross positioning of the ECD, the **MRI Technologist** acquires the SAG T2 sequence, and then pushes the images to the TDC computer using the instructions below.

9.b.iii Pushing and loading planning images from the MRI to TDC

MRI Technologist: Follow these steps to push images (such as SAG T2, AX T2, and AX T1) to the TULSA-PRO® network node.

Use the following steps if using R5 software:

1. Open Patient Administration by selecting **Patients > Administration**.
2. Search for the scan image you want to push to the Treatment Delivery Console (TDC) and select it.
3. Select the **TULSA** network node from the drop-down.
4. Click **Network** to send images to the TDC.

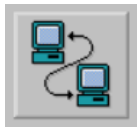

5. In TDC, click **Load ... Scan** to load the images into the TDC. Enter login credentials (see *User Accounts*). Valid scans will appear in the list; it might take a few seconds for the full list to update.
6. Select the appropriate T2w planning sequence, which is then loaded into the TDC software.

Use the following steps if using R12 software:

1. Planning scans will automatically be transferred to TDC. If the scan is not automatically transferred, right click the completed planning scan, select the **Export** option, and check the “TULSA” or “TULSAPRO” option under Network. Then click **Export**.
2. In TDC, click **Load ... Scan** to load the images into the TDC. Enter the login credentials (see *User Accounts*).
Valid scans will appear in the list; it might take a few seconds for the full list to update.
3. Select the appropriate T2w planning sequence, which is then loaded into the TDC software.



Always check that you have selected the image sequence from the correct patient and that the sequence was taken after you last adjusted the patient’s position. Note that it takes a few seconds for the newest scan to appear.

9.c Alignment

Radiologist: Use the Alignment workspace to define the location and angulation of the UA in the TDC software by aligning a graphical representation of the UA with the actual UA on the MRI image in three dimensions. Accurate alignment will be critical to safe and effective heat delivery within the intended tissue volume. See example below of the UA in MR images before (*Figure 35*) and after (*Figure 36*) Alignment.

1. Rotate the sagittal view to align the UA in the image with the gold UA overlay by clicking and dragging the light-blue circular overlay. Shift the sagittal view by clicking and dragging on the gold UA overlay. The length of the UA must overlap completely with the graphical UA overlay. In particular, the superior horizontal edge of the UA window on the graphical overlay must match the edge of the actual UA window on the SAG T2 images, which will be visible as a light-to-dark transition (hyper-intense signal within the acoustic window).
2. Similarly, rotate and shift the coronal view to align the actual UA with the graphical overlay.
3. Finally, shift the transverse view so that the circular graphical overlay overlaps completely with the cross-section of the actual UA. Transverse slices perpendicular to each transducer element are displayed on the left view of Alignment workspace (E1 to E10). The location of the center of each transducer element is represented by a red dot on the UA graphical overlay and must be centered within the UA in all images along the length of the device.
4. When satisfied with the alignment of the graphical representation of the UA and the UA in the MRI image, click the **Register UA** button to advance to **Coarse Planning**.

9. Treatment Planning

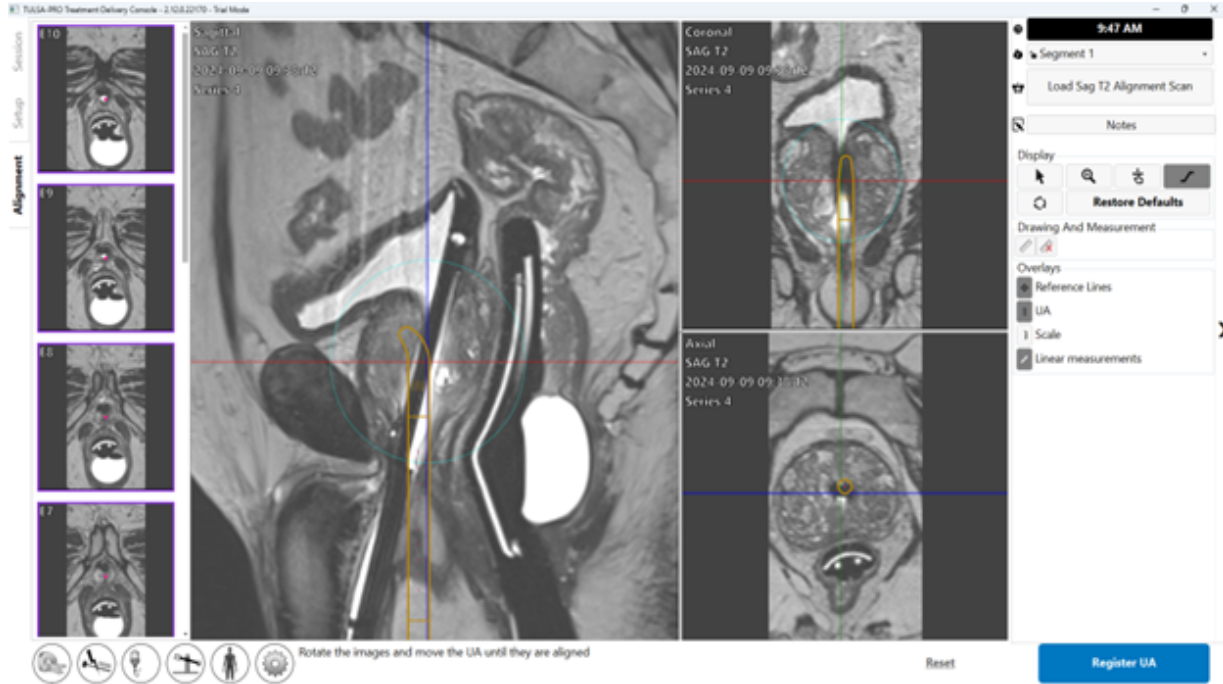

Figure 35: UA before alignment

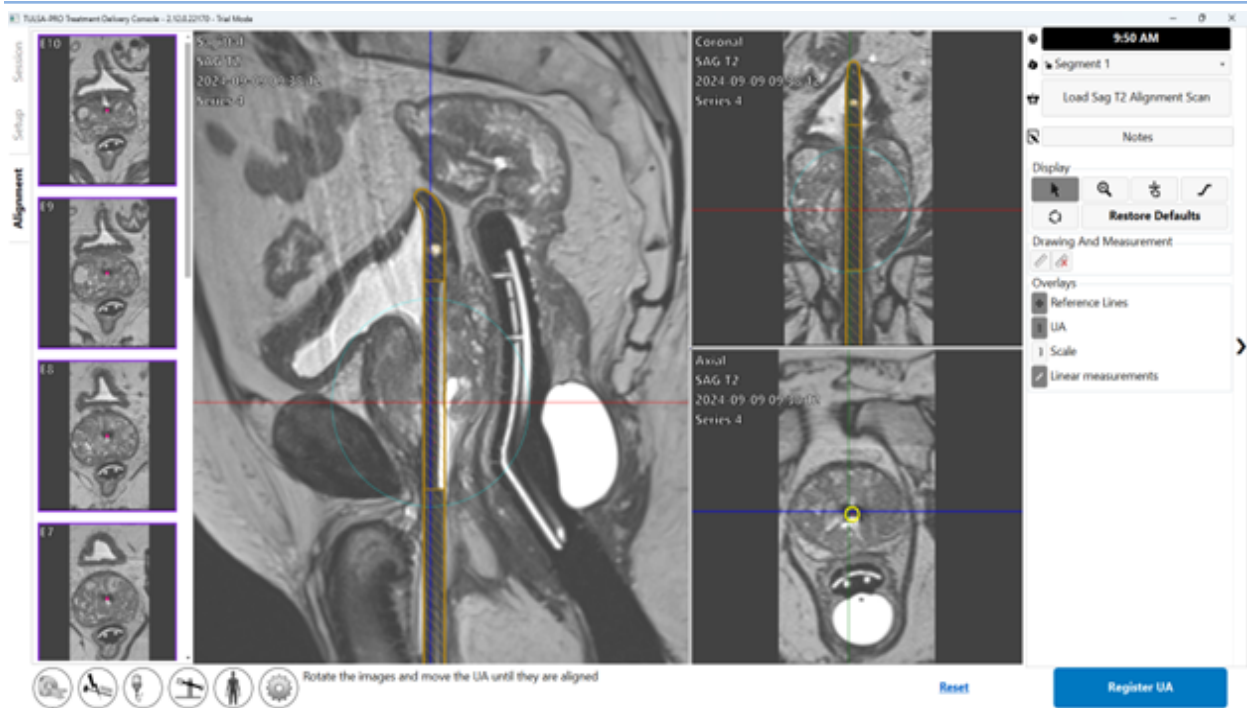

Figure 36: UA after alignment

9.d Coarse Planning

Radiologist: Define the treatable volume so that it covers the targeted tissue while sparing critical structures and minimizing the impact of small calcifications on the heating pattern, by adjusting the location

9. Treatment Planning

of the UA inside the prostate and selecting which transducer elements should be enabled.

The treatment volume is displayed as a green rectangle on the sagittal and coronal views. Regions beyond a light blue line displayed 4 mm from the bottom and top edges of the green rectangle on the sagittal and coronal views are anatomical regions expected to be spared fully from thermal coagulation (Figure 37).

1. Radiologist: Move the UA overlay in or out of the gland to prescribe the intended UA location, placing the active transducer elements beside the intended ablation volume. Click-and-drag the UA overlay to move it within the prostate in a linear, head-to-foot direction.



NOTE: When determining where to position the UA, identify the external urinary sphincter. If the external urinary sphincter cannot be identified, it should be considered immediately adjacent to the prostate apex. Place the light blue line (below the first element) on the external urinary sphincter (Figure 37).

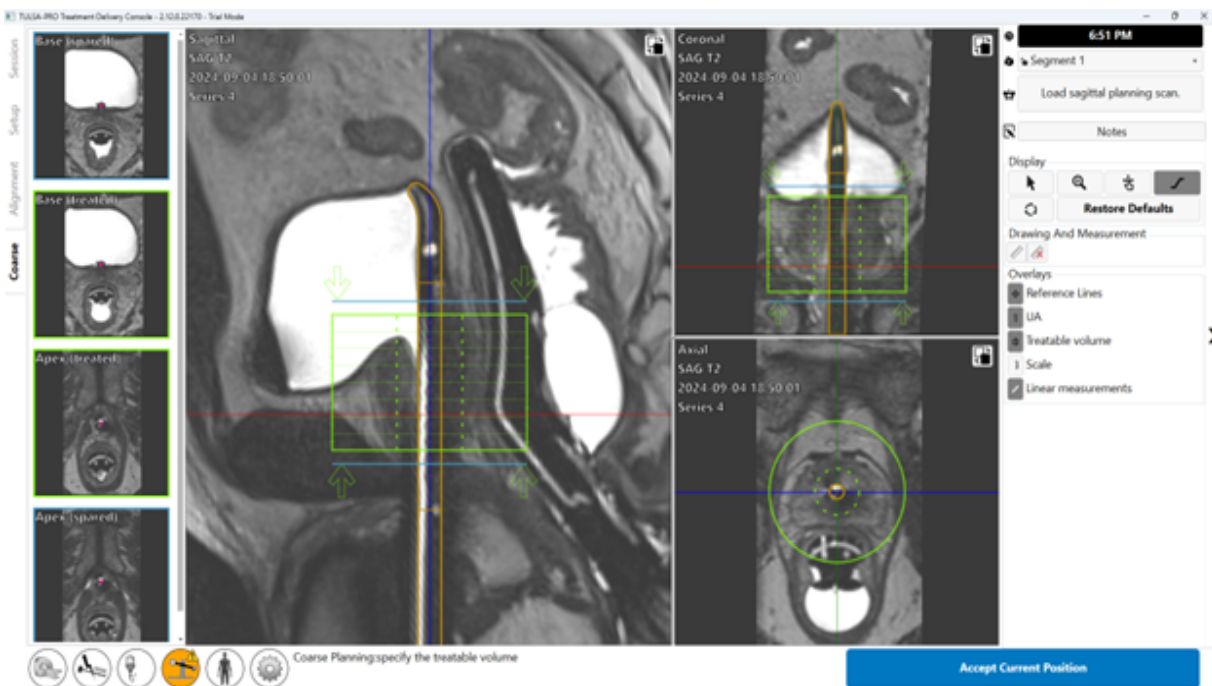

Figure 37: Coarse Planning workspace in TDC software

2. Radiologist: When adjusting the UA position, the presence of any small calcifications in the beam path should also be considered. Use the mpMRI Vision feature in Coarse Planning to load a set of sagittal susceptibility-weighted images (SWI), which highlight the magnetic field disturbances caused by intraprostatic calcifications. To reduce the shadowing effect of calcifications on ultrasound propagation and tissue heating, adjust the prescribed UA position to place the midline of the calcification between two adjacent ultrasound elements (instead of directly in front of an element) (Figure 38).
 - a. MRI technologist: Acquire a SAG SWI scan. Several output scans will be created automatically. Send the sagittal SWI output to TDC.

9. Treatment Planning

- b. Radiologist: Click **Load ... Scan** and select the SAG SWI scan to import it. The SWI scan will replace the existing SAG T2 3D scan in all three imaging planes. Toggle between viewing the SAG SWI and SAG T2 scans in each pane by clicking the mpMRI button in the top right corner.



NOTE: The SWI scan must be acquired after the initial SAG T2 scan and before moving the UA in Coarse Planning. If the UA is moved after acquiring the SAG SWI scan and a confirmation SAG T2 scan is loaded with the UA in the new position, the old SWI image will no longer be available.

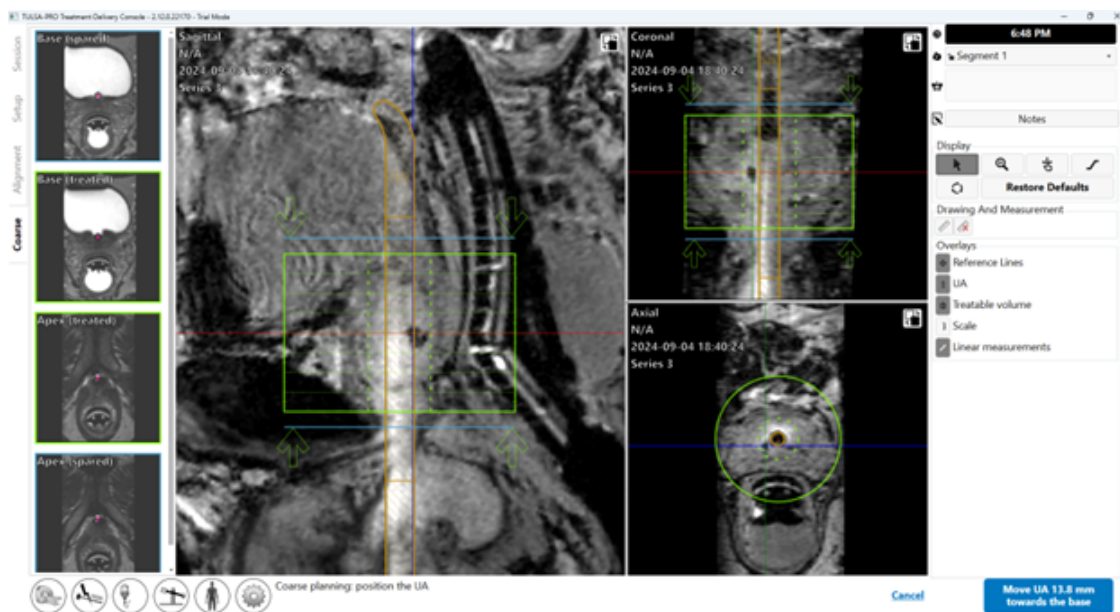

Figure 38: Using mpMRI Vision in Coarse Planning to triangulate calcification on a SAG SWI scan and adjusting the UA position to reduce the shadowing effect of the calcification on treatment

3. Once the UA position has been finalized using anatomical landmarks and accounting for calcifications, click **Move** for the positioning system to advance the applicator to the prescribed location or click **Cancel** to reset the prescribed adjustment. If no change is needed, click **Cancel** to reset the adjustment rather than attempting to manually move the UA overlay back to its original position.
4. If the UA is moved within the patient during Coarse Planning, a confirmatory SAG T2 scan must be acquired and loaded into TDC to accurately represent the updated shape of the prostate:
 - a. MRI Technologist: Acquire an additional SAG T2 scan and send it to the TDC.
 - b. Radiologist: Click **Load ... Scan** to import the new scan and confirm that the UA is in the intended location.
5. Radiologist: Once you are satisfied with the UA position and number of enabled elements, click **Accept Current Position** to proceed to Detailed Planning.

9.e Detailed Planning

Radiologist: After correctly positioning the UA in Coarse Planning, contour the prostate for each active ultrasound element with the help of a high-resolution device-axial T2 sequence (AX T2) and device-axial EPI thermometry images (AX THERM), acquired by the MRI Technologist. These images are acquired in twelve slices transverse to the UA: ten images centered on the individual ultrasound transducer elements, and two additional “monitoring” images near the prostate apex and base.

Anesthesiologist: Immediately before acquiring the treatment planning images and before treatment delivery, administer a GI anti-spasmodic drug to reduce GI peristalsis if directed by treating physician.

9.e.i Acquiring the treatment planning images

MRI Technologist: On the MR Console, follow these instructions to acquire device-aligned AX THERM, AX T2 and AX DWI images.

Use the following steps if using R5 software:

1. **MRI Technologist:** Open AX THERM for editing in the **Offc/Ang** tab, change the AP, RL, and FH values for both *Stack Offc.* and *Ang* (Figure 40). to match those in TDC. Do the same for the shim volume. If the shim volume includes more than just the patient anatomy (such as air), reduce the size of the shim box (Figure 39).

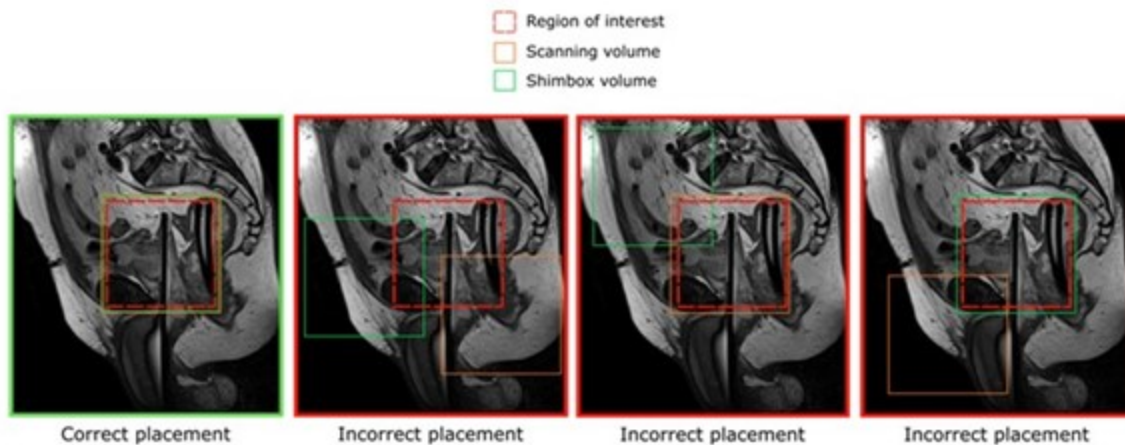

Figure 39: Examples of correct and incorrect placements of the shim box

2. **MRI Technologist:** To optimize image quality for AX THERM, force the MRI to acquire new prescans. In the top menu on the MRI console, select **Examinations > Repeat Prescans**.
3. **MRI Technologist:** Run the sequence. TDC should automatically receive the thermometry images. As the thermometry scans are received, the **Magnitude** and **Temperature Uncertainty** views will be displayed to facilitate treatment planning (Figure 40).

9. Treatment Planning



NOTE: If the scanner prompts a message about table movement, cancel the sequence and repeat steps 9.e.i.1 and 9.e.i.2. **If the table is moved after acquiring the last SAG T2 scan, you must acquire a new SAG T2 scan and return to the Alignment workspace (Alignment).**

4. **MRI Technologist:** Prescribe and run the AX T2 and AX DWI sequences.
 - a. Since it is on the same Geo as AX THERM, verify that the coordinates are the same in the Offc/Ang tab. Run the sequence.
 - b. When the scan is complete, push the AX T2 images to TDC (see *Pushing and loading planning images from the MRI to TDC*).
 - c. Repeat the steps above to prescribe and run the AX DWI sequence ("mpMRI Vision" on page 56).
 - d. Once finished, push the ADC map and/or the calculated high-b value reconstructions to TDC.

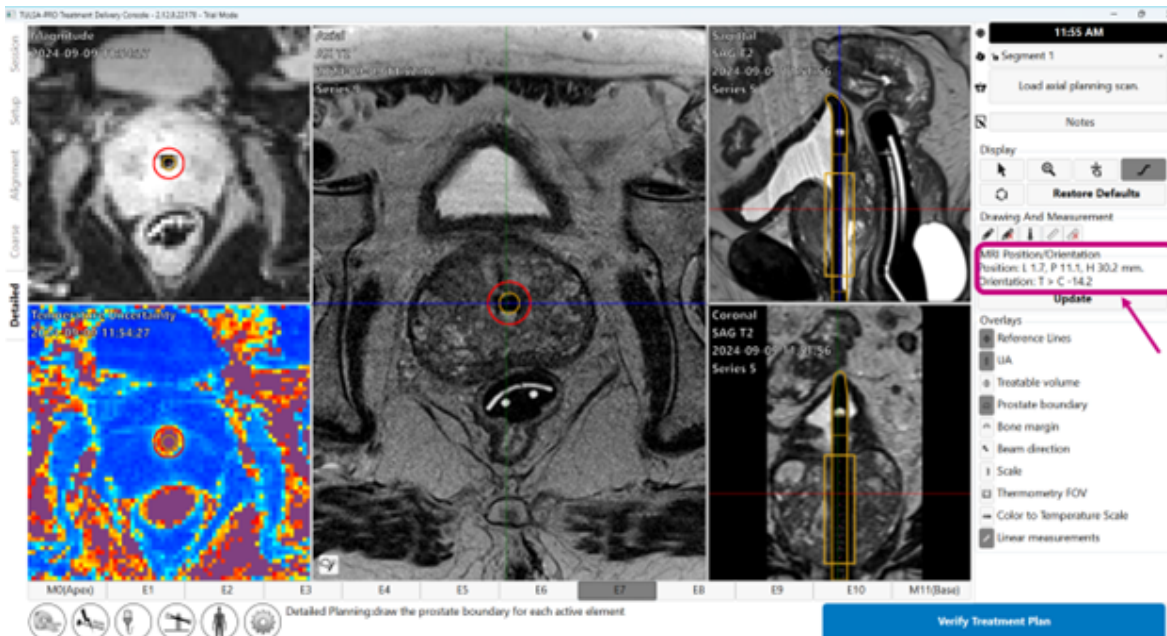

Figure 40: Detailed Planning workspace with Thermometry Magnitude and Temperature Uncertainty (MRI Position/Orientation coordinates used to prescribe treatment planning images are highlighted)

Use the following steps if using R12 software:

MRI Technologist: On the MR Console, follow these instructions to acquire device-aligned AX THERM, AX T2, and AX DWI images.

1. **MRI Technologist:** Select the AX THERM scan and click **Plan**, then click **Accept**.
2. **MRI Technologist:** Prescans will be applied automatically when TDC starts the AX THERM scans.
3. **MRI Technologist:** Run the sequence by clicking **Start Thermometry** in TDC (Figure 40). TDC should automatically receive the thermometry images. As the thermometry scans are received, the **Magnitude** and **Temperature Uncertainty** views will be displayed to facilitate treatment planning.

9. Treatment Planning



NOTE: If the scanner prompts a message about table movement, cancel the sequence and repeat steps 9.e.i.1 and 9.e.i.2. **If the table is moved after acquiring the last SAG T2 scan, you must acquire a new SAG T2 scan and return to the Alignment workspace (Alignment).**

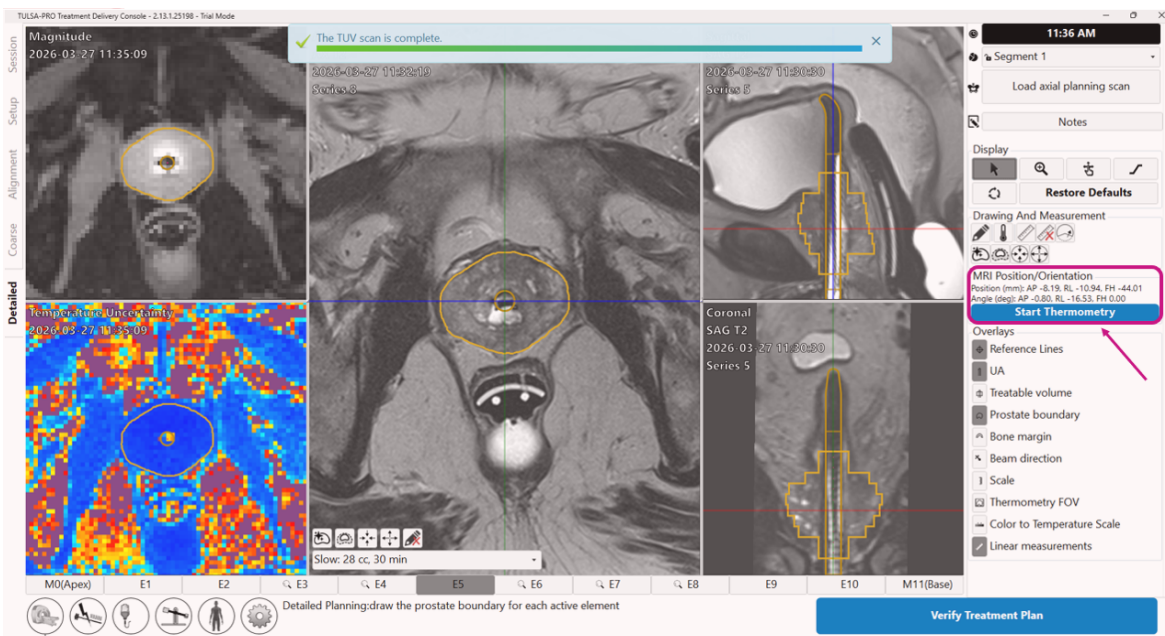

Figure 41: Detailed Planning workspace with Thermometry Magnitude and Temperature Uncertainty ('Start Thermometry' and MRI Position/Orientation coordinates used to prescribe treatment planning images are highlighted)

5. MRI Technologist: Prescribe and run the AX T2 and AX DWI sequences.

- Since it is an axial scan, TDC will set the scan volume the same as the AX THERM. Verify that the coordinates are the same in the **Offc/Ang** tab. Run the sequence.
- When the scan is complete, push the AX T2 images to TDC (see *Pushing and loading planning images from the MRI to TDC*).
- Repeat the steps above to prescribe and run the AX DWI sequence ("mpMRI Vision" on page 56).
 - Once finished, push the ADC map and/or the calculated high-b value reconstructions to TDC.

9.e.ii Treatment planning guidelines

Radiologist: The target boundary should be drawn on all AX T2 images that contain prostate tissue intended to be treated. On each slice with a boundary, the prostate boundary must contain the UA center. The location of the UA center should be the same on all slices. Slices that do not have any defined prostate boundary will not be active during treatment delivery (in other words, no ultrasound power will be delivered by that element). Boundaries drawn too close to the UA will appear red and will not be treated.

9. Treatment Planning

1. Draw or edit the boundary to outline the tissue to be ablated on each slice based on the corresponding AX T2 and THERM magnitude images (*Figure 42*). Tools to customize the boundary are described in the following *mpMRI Vision*, *Treatment Arc*, *TULSA-AI Volume Reduction (VR)*, and *Contouring Assistant*. You can select individual slices by clicking on the numbered tab at the bottom of the screen or by pressing the left and right arrow keys on the keyboard. Use the sagittal and coronal views of the SAG T2 images to verify the intended ablation zone in three dimensions.



NOTE: If the displayed slice is not part of the treatable volume, the drawing cursor will be disabled. If you need to draw on this slice, return to Coarse Planning, click **Unlock**, and add this slice to the treatable volume.



NOTE: When drawing the boundary for a current slice or re-positioning the UA center, you can restore the boundary to a previous drawing (undo [CTRL+Z]) or apply a boundary change [redo (CTRL+Y)], as much as needed. When you move to a new slice, you cannot undo changes on previous slices.

The color of the prostate boundary indicates possible conditions:

- A gold boundary is a valid boundary.
- A pink boundary is valid and ultrasound will be directed to those areas, but it extends beyond the expected maximum treatable radius and thermal coagulation might fall short of the target boundary in those areas.
- A red boundary represents an area that is excluded from the target prostate volume because it is too close to the UA.



NOTE: You can progress to **Treatment** if parts of the boundary are red, but ultrasound energy will not be directed to those areas.

- A purple boundary represents an invalid boundary because the boundary was drawn on a region with high temperature uncertainty.



NOTE: You cannot progress to **Treatment** if parts of the boundary are purple.

2. When all planning steps are completed and verified, click **Verify Treatment Plan**.



A warning icon is displayed next to each region where there is high temperature uncertainty on the calculated control boundary, and on the numbered tab of any element with an invalid boundary.



A review icon is displayed on each element tab where a change to the active target boundary has been made while not in the active viewport. All slices with a magnifying glass icon (🔍) on the slice tab must be reviewed before proceeding to **Treatment Delivery**.





NOTE: The target boundary should not be drawn outside of the prostate gland and should not include urine or important peri-prostatic anatomy, such as the rectum, neurovascular bundles, external urinary sphincter, bladder wall, or pelvic bone. Including urine or important peri-prostatic anatomy within the prostate boundary could result in thermal damage to structures outside the prostate, which could lead to treatment-related harms that may include rectal fistula, other bowel complications, erectile dysfunction, retrograde ejaculation, urinary incontinence, other urinary complications, or damage to the pelvic bone and/or nerves adjacent to the pelvic bone.



NOTE: Bone has significantly higher ultrasound attenuation and absorption than soft tissue, which can result in significant heating of bone and adjacent soft tissue. Since the pelvic bone can tolerate some small amount of thermal damage and soft tissues adjacent to the pelvic bone are often of little concern, the volume/area of at-risk pelvic bone and its proximity to other important structures (such as nerves) should be considered carefully.

- Bone may be at risk of significant heating during treatment if located within 32 mm from the UA center and the defined prostate boundary is greater than 14 mm in those areas.
- Soft tissues adjacent to bone may be at risk of significant heating if they are located within 40 mm from the UA center and the defined prostate boundary is greater than 14 mm in those areas.

Given the conditions above (which can be visualized using the  Bone Margin overlay), the worst-case probability of significant heating is estimated to be 25%.



NOTE: Anomalies in the prostate should be identified (including but not limited to cysts and calcifications) on the treatment planning images. The prostate boundary should be at least 5 mm away from these anomalies. The risk of heating in sectors containing cysts is overtreatment outside the prostate due to their low ultrasound attenuation/absorption.



NOTE: For partial gland ablation, contour the entire prostate in **Detailed Planning** and, if enabled, use the **Treatment Arc** feature to prescribe where ablation should start and finish. If the **Treatment Arc** feature is not available during treatment **Delivery**, use the start angle to define where ablation should begin, and then manually stop treatment when thermal coverage of the desired angular segment is reached.

9. Treatment Planning



NOTE: Temperature uncertainty is expected to be uniformly low (blue on the temperature-uncertainty color scale) within the prostate and in the muscles lateral to the gland. Large amounts of intermediate (yellow-red) or severe (purple) temperature uncertainty in these regions can indicate thermometry artifacts that could affect patient treatment. If you suspect thermometry artifacts, check for the following before proceeding to treatment:

- tissue abnormalities within the gland
- patient motion due to breathing or contraction of pelvic floor muscles
- incorrect imaging coil placement
- incorrect UA or ECD placement
- air or feces within the rectum
- incorrect prescription of THERM scan.

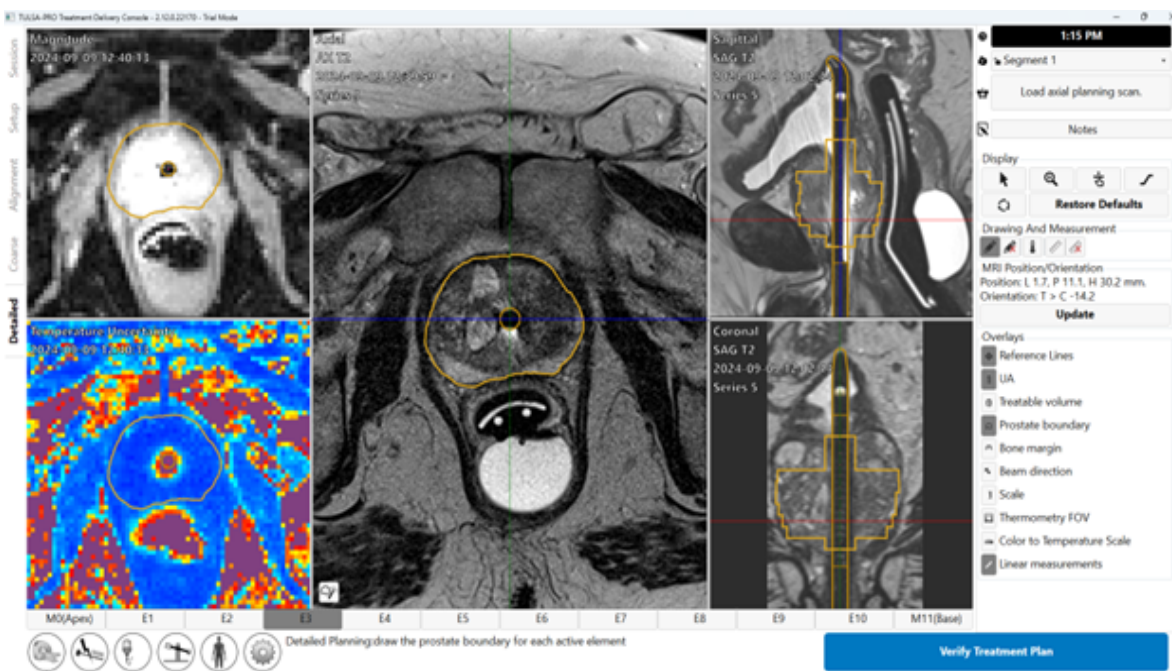



Figure 42: Detailed Planning after drawing boundaries

9.e.iii mpMRI Vision

Radiologist: When prescribing the treatment volume, use the mpMRI Vision feature in *Detailed Planning* to load a set of axial diffusion weighted images (DWI), which can be used to visualize intraprostatic differences in prostate tissue to help select tissue intended for ablation (Figure 43).

1. **MRI technologist:** Acquire an AX ADC or high b-value scan. Several output scans will be created automatically. Send either the apparent diffusion coefficient (ADC) map or the calculated high b-value DWI to the TDC, based on physician preference.

9. Treatment Planning

2. Radiologist: Click **Load ... Scan** and double-click the new AX DWI scan to import it. The DWI scan will replace the existing AX T2 scan in the transverse view. Toggle between viewing the AX DWI and AX T2 scans by clicking the mpMRI button () in the top right of the transverse view.

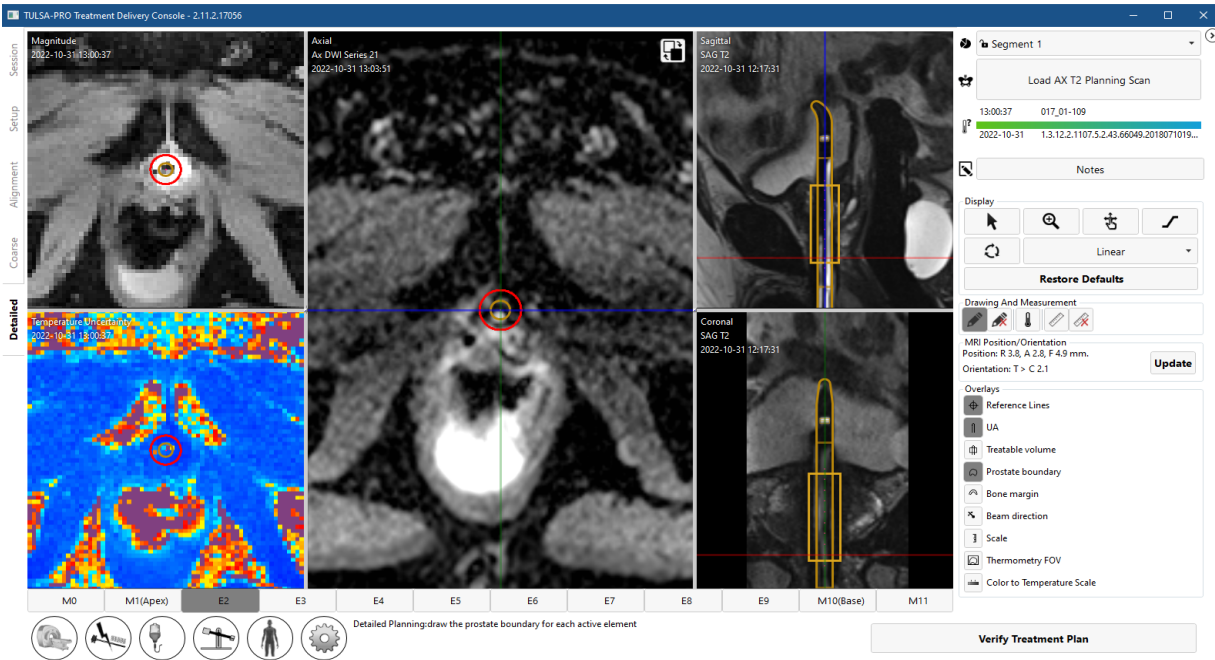



Figure 43: Using mpMRI vision in Detailed Planning to visualize intraprostatic differences in tissue properties on an AX DWI scan and select tissue intended for ablation

9.e.iv Treatment Arc

Radiologist: If enabled, the TDC Software might include the **Treatment Arc** feature to use in defining the angular extent of the desired sector of ablation across all elements for subtotal prostate ablation. When applied, the **Treatment Arc** defines the UA rotation start angle, direction of rotation, and an end angle at which ablation will automatically pause during **Delivery**. Portions of the prostate boundary outside the **Treatment Arc** will be displayed in red and will not be treated.

1. After all prostate boundaries are defined, click the Treatment Arc button () to enable the **Treatment Arc** overlay.
2. To adjust the **Treatment Arc**, click the end of the yellow angle indicator and drag it to the desired angle.
3. The start angle shows a yellow triangle near the end of the yellow angle indicator and a larger arrow beyond the angle indicator. To change the direction of rotation through the **Treatment Arc**, click the large arrow to switch the start and end angles as well as the direction of rotation.



NOTE: You can disable the **Treatment Arc** by clicking the Treatment Arc button () in the Drawing and Measurement tool area.

9. Treatment Planning

Radiologist: If Treatment Arc is not enabled, set the UA rotation start angle and direction of rotation using the Beam Direction tool ( Beam direction).

1. Click the Beam Direction tool ( Beam direction) to enable the **Beam Direction** overlay.
2. Click on the orange arrow once to change the clockwise or counter-clockwise direction of UA travel at the start of treatment.
3. Adjust the starting position of the UA by clicking and dragging on the orange dot beside the arrow.



NOTE:Avoid starting ablation therapy with the UA pointed at sensitive structures, such as the neurovascular bundles or rectum.

When ablation begins, the controller rapidly rotates through the first 15 angular degrees and may rotate further before heat initially builds up to the target boundary, depending on target radius. Consider this angular margin when defining the start angle.

9.e.v Contouring Assistant

If enabled, the TDC Software might include the TULSA-AI Contouring Assistant feature. In **Detailed Planning**, after the Axial T2 planning image is loaded this feature automatically contours all slices where prostate is detected.

These predicted contours provide a starting point for drawing the prostate boundary. The physician must then review and change all predicted boundaries as needed to prescribe the appropriate treatment plan.



- To return to the original predicted contour for a particular slice, click the Contouring Assistant button () in the bottom left of the Axial viewport. If prostate tissue was originally detected on that slice, the software-assisted contour will appear.
- To revert all modified slices to the original predicted contours at once, click the global application Contouring Assistant button () in the drawing and measurement tool area (*Figure 44*).



Figure 44: Drawing and Measurement tool area

9. Treatment Planning

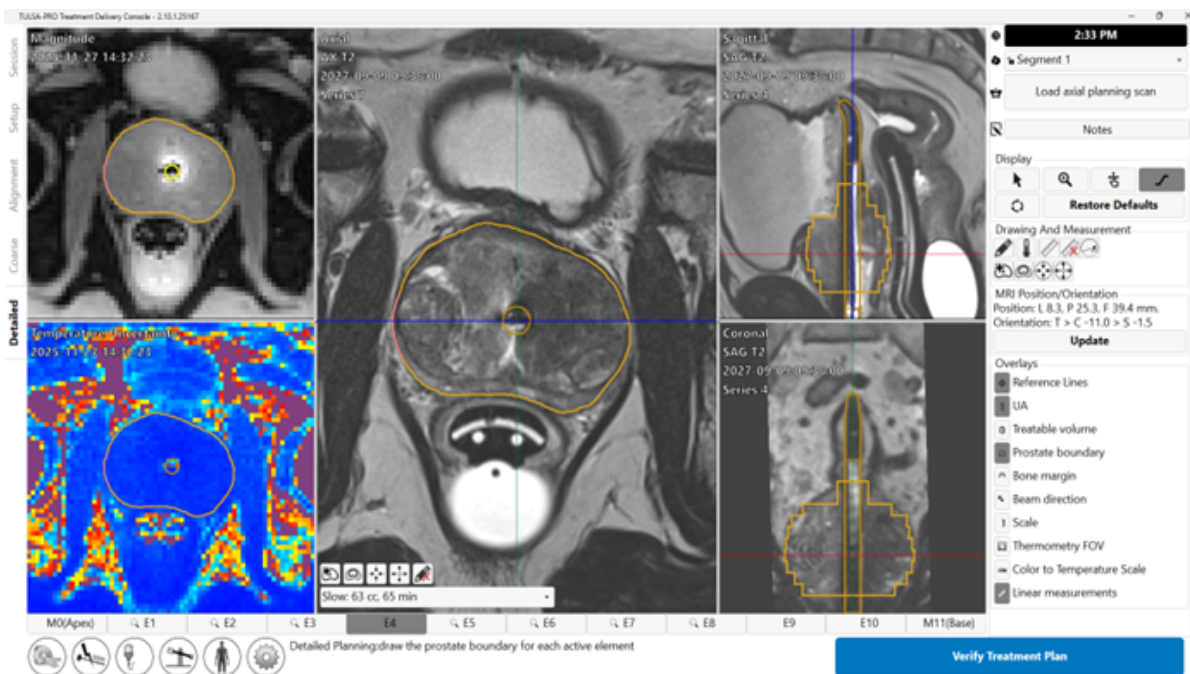

Figure 45: Using the Contouring Assistant feature in Detailed Planning to apply a software-assisted prostate boundary as a starting point for treatment planning on a selected slice

9.e.vi TULSA-AI Volume Reduction (VR)

If enabled, the TDC Software might include the **TULSA-AI Volume Reduction** module. This module allows rapid definition of treatment plans aimed to reduce the volume of the prostate. The physician can then review and further edit the boundary to prescribe the appropriate treatment plan.

Applying Volume Reduction to all slices

After the prostate boundaries have been defined (manually or automatically), the physician can click the **Volume Reduction** button (🔧) in the **Drawing and Measurement** tool area to automatically adjust the boundaries on all slices to spare posterior prostate tissue adjacent to the rectum, neurovascular bundles, ejaculatory ducts, and tissue adjacent to the prostate apex and bladder neck (Figure 46). To further reduce the boundaries following the same sparing logic, click the **Volume Reduction** button repeatedly until the desired treatment plan is achieved.

The **Volume Reduction** tool automatically enables the **Treatment Arc**, setting the starting beam angle to 4:30 clock position and the end angle to 7:30, for counter-clockwise ablation of the anterior aspect of the prostate away from critical anatomical structures, such as the rectum, neurovascular bundles, and ejaculatory ducts.



NOTE: When applied to all slices, the **Volume Reduction** tool removes the target boundary on the slice nearest the apex. It also removes the target boundary on the slice nearest the base if it contains less than 3cc of prostate tissue.

9. Treatment Planning

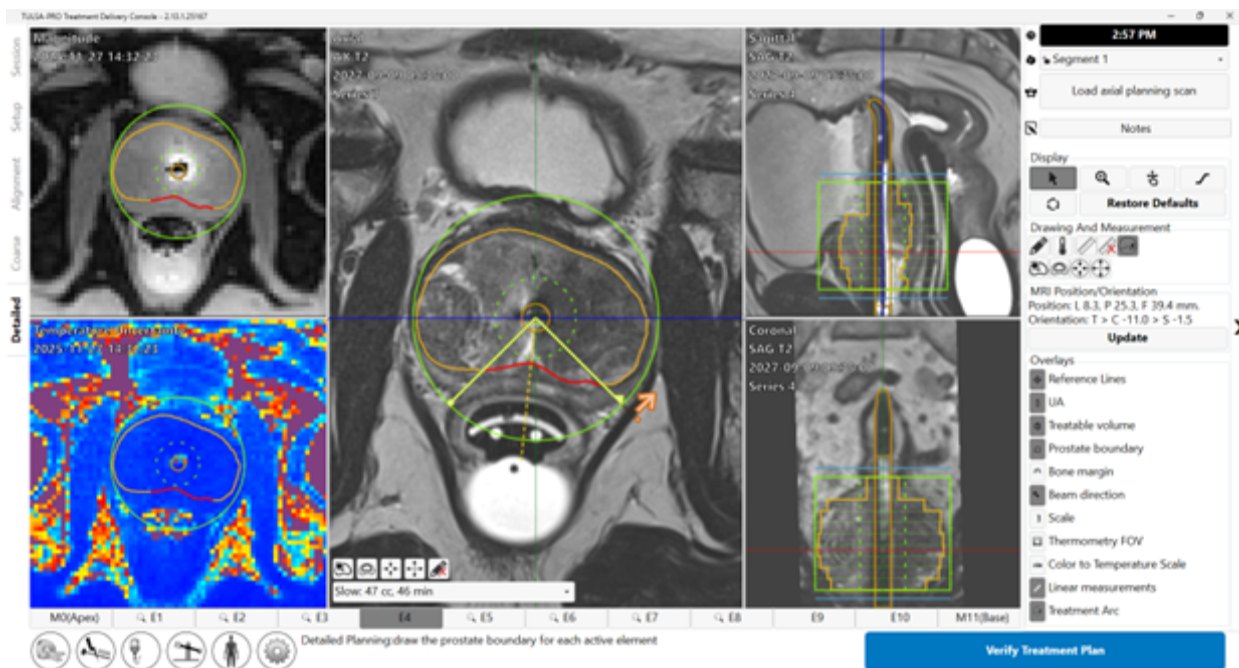

Figure 46: Treatment Planning with Volume Reduction tool applied

Applying Volume Reduction to a single slice

The **Volume Reduction** tool can also apply sparing on an individual slice. To apply software-assisted sparing margins to a slice with an existing boundary drawn, click the **Volume Reduction** button (🔧) in the bottom left of the Axial viewport.

Contracting or expanding boundaries

Once Volume Reduction has been applied, you can make adjustments in 1mm steps to the entire boundary using the contract and expand button (available only if the TULSA-AI Volume Reduction feature is enabled).

To quickly contract or expand the boundaries, click the Contract (⊖) or Expand (⊕) boundaries buttons:

- For global application to all slices, the Contract and Expand buttons are located in the **Drawing and Measurement** tool area (Figure 44).
- For individual slice application, the buttons are located in the bottom left of the Axial viewport.

Treatment Volume Selection

To further optimize treatment for prostate volume reduction, the TULSA-AI Volume Reduction feature includes the ability to control the minimum ablation speed. After target boundaries are defined, adjust the treatable volume using the drop-down menu in the axial viewport.

9. Treatment Planning

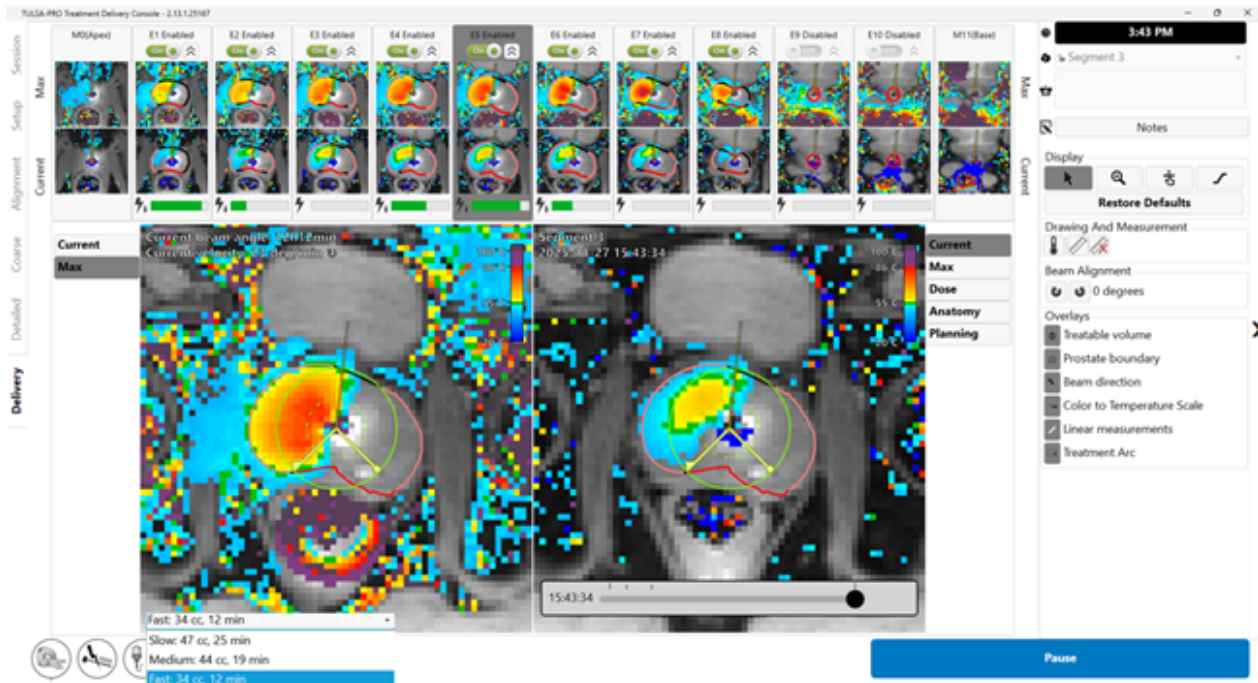

Figure 47: Treatable volume selection drop-down

Each selection displays an overlay of the expected treatment depth for a given ablation speed and lists:

- the minimum rotation speed for that setting
- the expected volume of ablated prostate tissue (based on the defined treatment plan), and
- the expected ablation time for the treatment.

Higher ablation speeds might limit the amount of prostate tissue ablated at treatment radii that exceed the expected ablation depth, while reducing the expected ablation time.

10. Treatment Delivery

Radiologist: Start prostate ablation according to the treatment plan defined in **Detailed Planning**. Confirm the treatment plan with the **Urologist**, notify the Anesthesiologist to prepare the patient for treatment, and instruct the **MRI Technologist** to initiate MR thermometry.

The *Delivery* workspace displays information from 12 axial slices in real time: 10 slices corresponding to the elements (E1-E10) that can deliver heating, and two additional slices corresponding to the Monitoring Elements, M0 and M11 (10). Images are updated every 5 to 7 seconds during treatment as new images from the MR scanner are processed into temperature information.

In the main viewport, the enlarged image on the left shows either Current or Maximum Temperature from a selected slice. The enlarged image on the right shows the same slice in one of several selected display modes.

Above the main viewport, smaller (thumbnail) views of all slices are displayed in two rows of 12 images. The top row shows all slices in the display mode selected for the left enlarged image. The second row shows all slices in the display mode selected for the right enlarged image. Click on any slice in the top rows to show the corresponding slice enlarged below. You can also move between individual slices by pressing the left and right arrow keys on the keyboard.

The following display modes are available for the right enlarged image:

1. **Current temperature** view displays a color map of the most recently acquired thermometry image.
2. **Maximum temperature** view displays a color map of the maximum temperature from the start of treatment.
3. **Dose** view displays a color map of the cumulative, quantitative measure of thermal dose.
4. **Anatomy** view displays the most recently acquired thermometry magnitude image.
5. **Planning** view displays the most recently acquired AX T2 and AX DWI planning images. Toggle between AX T2 and AX DWI by clicking the mpMRI button ().

NOTE: Planning images are not dynamically acquired during treatment delivery and might not reflect the current anatomical configuration if motion has occurred during treatment.

10.a Starting position and direction of rotation

Radiologist: Before initiating treatment, adjust the starting position and direction of the UA rotation in the TDC **Delivery** tab. Avoid starting ablation therapy with the UA pointed at sensitive structures, such as the neurovascular bundles or rectum. Click on the orange arrow once to change the intended clockwise or counter-clockwise direction of UA travel at the start of treatment. Adjust the starting position of the UA by clicking and dragging on the orange dot beside the arrow (*Figure 48*). Once initialization starts, the controller will rotate the UA to the starting direction before ablation starts.



NOTE: When ablation starts, the controller rapidly rotates through the first 15 angular degrees and might rotate further before heat initially builds up to the target boundary depending on target radius. Consider this angular margin when defining the start angle.

10. Treatment Delivery

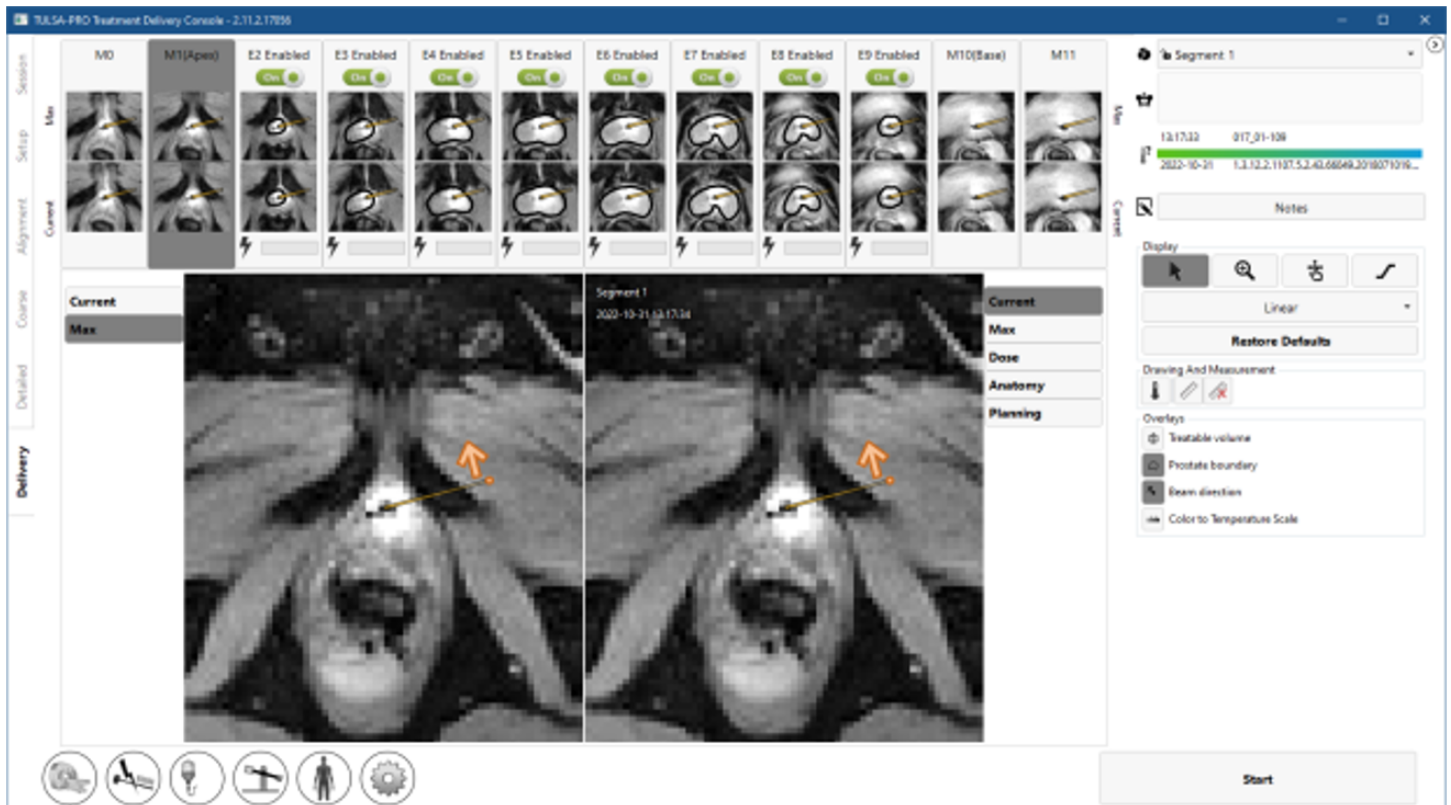

Figure 48: Delivery workspace of TDC software: Drag the orange dot to define the starting UA angle, and click the orange arrow to define the direction of rotation

10.b Treatment Initialization

Radiologist: When you have finished planning and are ready to start treatment, instruct the Anesthesiologist to administer a second dose of GI anti-spasmodic drug if appropriate. This will reduce GI peristalsis during treatment delivery and help maintain stable temperature maps.

Use the following steps if using R5 software:

1. **MRI Technologist:** Prepare a long AX THERM sequence for treatment.
 - a. Duplicate the AX THERM sequence on the MRI console.
 - b. In the Dyn/Ang tab, increase the number of dyn scans to the maximum allowed value or as instructed by the Radiologist.
 - c. In the top menu on the MRI console, select **Examinations > Repeat Prescans**.
 - d. **Do not run the scan until instructed by the physician.**
2. **Radiologist:** Click **Start treatment** on TDC. It will prompt you to verify the core body temperature using an external temperature measurement device before proceeding. Enter the temperature in degrees Celsius and click **Confirm**. The TDC will go into **Treatment Initialization** and is now ready to

10. Treatment Delivery

receive thermometry images (*Figure 49*).



NOTE: Core body temperatures outside the normal range of 35-39°C will require an additional confirmation.

If the core body temperature is less than 30°C or higher than 40°C, treatment is not allowed.

3. **MRI Technologist:** Run *AX THERM* on the MR Host.

Use the following steps if using R12 software:

1. **MRI Technologist:** Duplicate the *AX THERM* sequence for treatment that was used to collect the TUV scan on the MRI console.
2. **Radiologist:** Click **Start treatment** on TDC. It will prompt you to verify the core body temperature using an external temperature measurement device before proceeding. Enter the temperature in degrees Celsius and click **Confirm**. The TDC will go into **Treatment Initialization** state and will start the thermometry scan on the MR console (*Figure 49*).



NOTE: Core body temperatures outside the normal range of 35-39°C will require an additional confirmation.

If the core body temperature is less than 30°C or higher than 40°C, treatment is not allowed.

The first 25 imaging dynamics are received during the **Treatment Initialization** state, where all hardware is configured to prepare for heat delivery. During this step, the Radiologist should closely monitor the magnitude and thermometry images and click **Stop Initialization** if there is evidence of severe thermometry artifacts or patient motion that could affect treatment.

10. Treatment Delivery

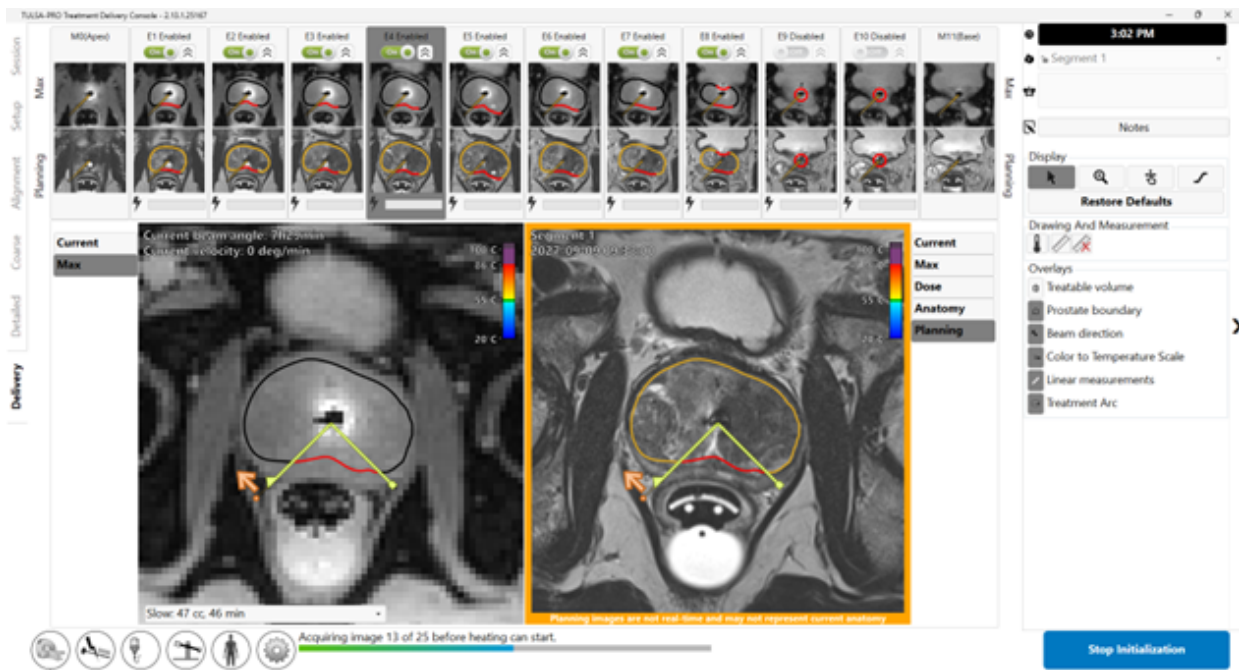

Figure 49: Treatment Initialization state

10.b.i Monitoring Treatment Delivery

Radiologist: After receiving 25 thermometry dynamics, heating begins (*Figure 50*). Throughout the ablation, actively monitor real-time treatment images on all slices, ensuring that:

- The observed heating pattern on the Current Temperature display matches the expected heating direction and depth. The Current Temperature image is used by the software to automatically adjust treatment parameters.
- There are no erroneous temperature measurements in unheated regions of the prostate due to artifacts caused by gross patient motion, excessive prostate swelling, contraction of the pelvic floor muscles, displacement of gas in the rectum, bladder filling, or RF interference.

If unintended heating or gross patient motion is suspected, click **Pause** to temporarily disable heating on all elements without stopping MRI thermometry, giving you time to evaluate the situation.

The following subsections describe the use of software features to fine-tune parameters during treatment delivery.

10. Treatment Delivery

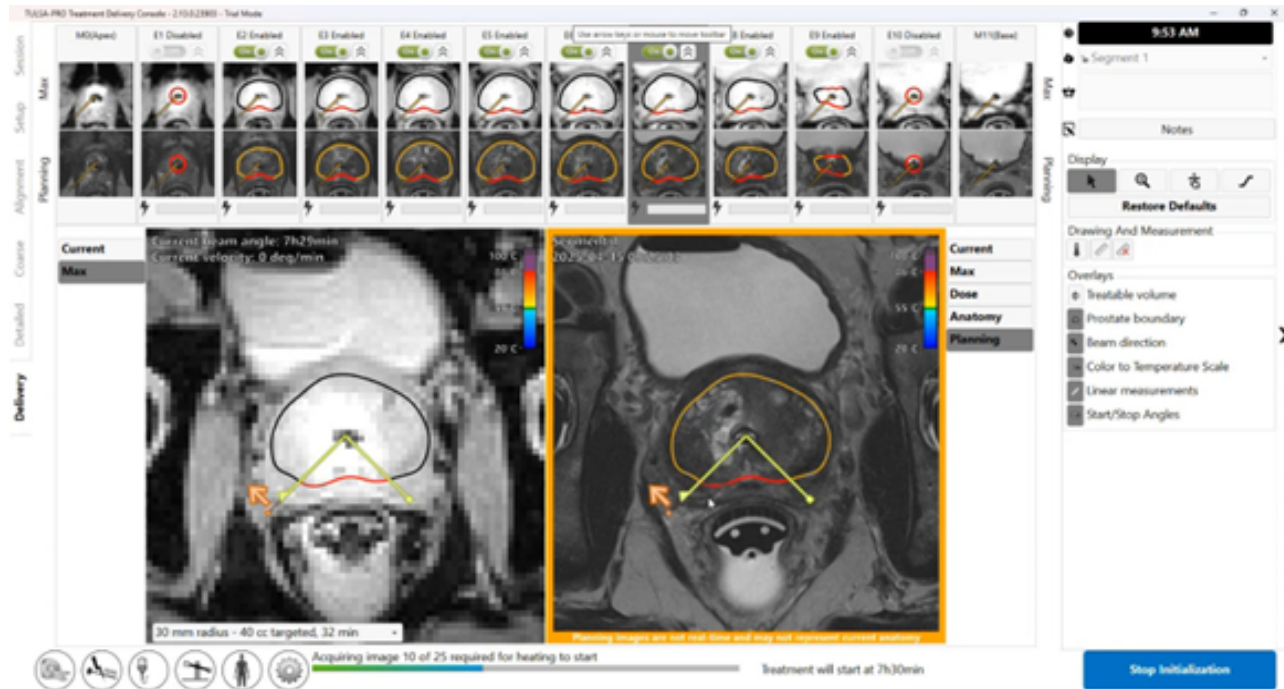

Figure 50: Ultrasound heating has begun

MRI Technologist: On the MR console, monitor the amount of time remaining in the THERM acquisition and notify the Radiologist when there are only a few minutes remaining.

10.c Toggling Power to One or More Treatment Elements

Radiologist: The power and frequency delivered on each active element is shown for each slice in real-time; power is shown by a solid, green bar. Hover the cursor over the power bar to display the actual value of the frequency and delivered power.

If unintended heating of important structures outside the prostate is observed at any time, unselect the switch to disable power to that element (*Figure 51*).

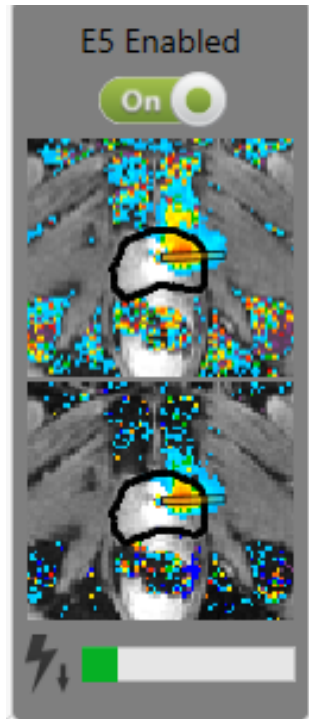

Figure 51: Active element in the Delivery workspace
(Green bar shows power is being delivered from this element.
Down-arrow indicates element is operating at low frequency.)

10.d Adjusting Treatable Volume Selection During Delivery

If included with your TDC Software, the TULSA-AI Volume Reduction (VR) feature includes the **Treatable Volume Selection** tool. This feature is available during the detailed planning phase to help optimize the treatment plan, but also at any time during Delivery (pre-treatment, initialization, during treatment and when paused), you can select a different treatment depth and associated estimated treatment time. When you change the **Treatable Volume Selection** drop-down in the axial viewport, the treatable volume overlay displays to help visualize the change and its impact to the treatment boundaries defined for the active slice(s).

10. Treatment Delivery

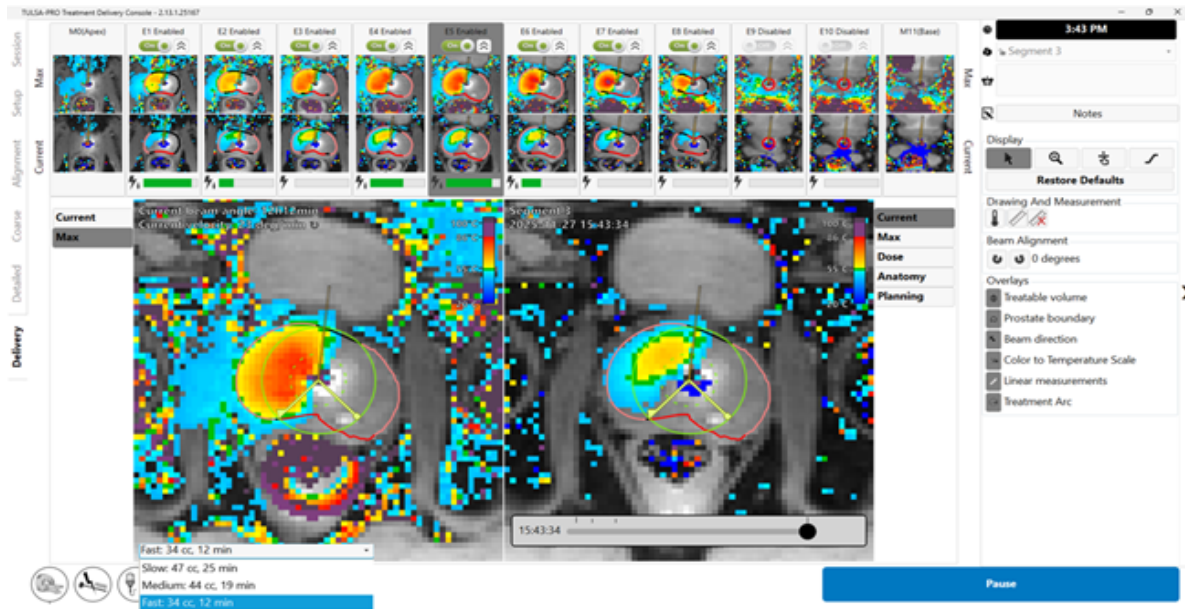

Figure 52: Treatable Volume Selection drop-down

Each selection highlights the treatment radius, the expected ablation volume of prostate tissue (based on the defined treatment plan), and the expected ablation time for the treatment. Smaller treatment radii will limit the amount of prostate tissue that can be ablated and lower the expected ablation time.

10.e Adjusting Beam Alignment during Treatment

Radiologist: To execute a successful TULSA-PRO® treatment, the actual direction of ultrasound heating must correspond to the heating direction expected in the TDC software. You can determine the actual direction of ultrasound heating directly by examining the heat pattern on the MRI Thermometry image during ablation.

The expected heating direction in the TDC software is represented by a feature called the **UA Beam Angle** (Figure 53), which is a visual overlay over the MRI Thermometry image and represented as a line extending radially outwards from the UA center.

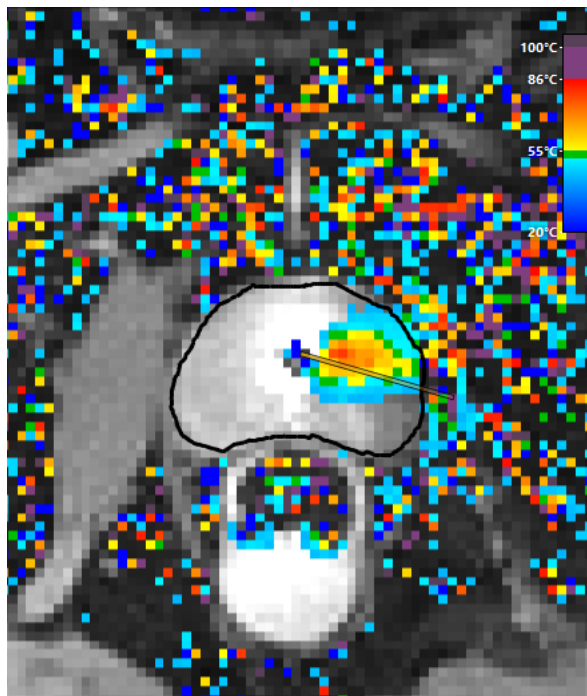

Figure 53: UA beam orientation overlay

It is the Radiologist's responsibility to ensure that the actual direction of ultrasound heating as observed in the temperature maps corresponds with the UA beam angle at the start of delivery.



During treatment delivery, if it is observed that the direction of ultrasound heating and the UA beam angle do not correspond or align with each other on the Current Temperature view (Figure 54), adjust the beam angle. If the adjustment does not resolve the problem, click **Pause and create a new treatment segment (see *Creating a new Treatment Segment*) to suspend ultrasound delivery and thermometry acquisition. Enter the MRI magnet room to ensure the UA is properly mated to the PS. If the problem persists, contact a **Profound Medical** authorized service representative.**

10. Treatment Delivery

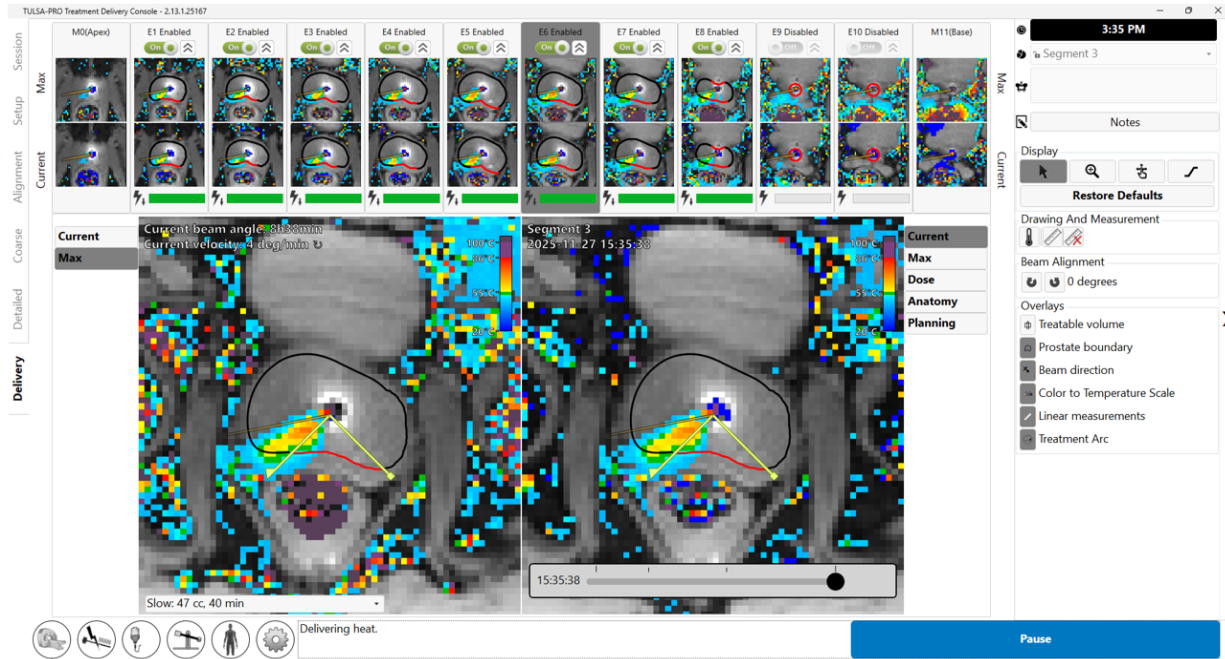



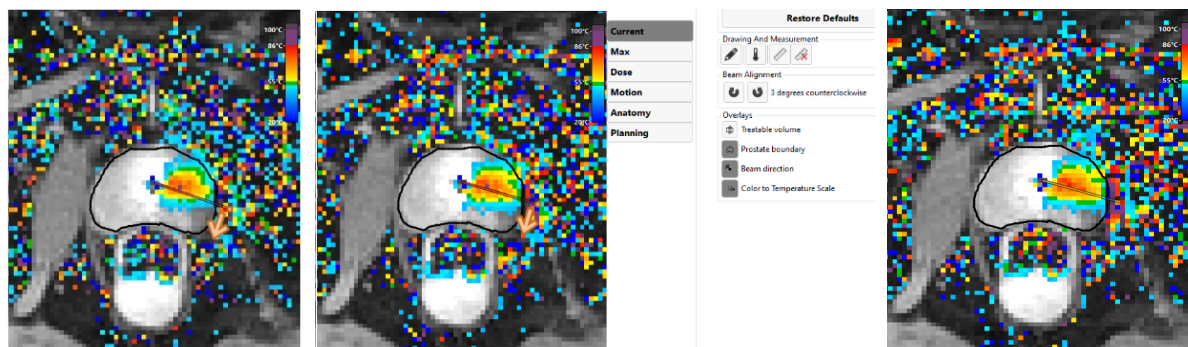

Figure 54: Misaligned ultrasound heating and UA beam angle

To adjust the UA beam angle at any time, expand the right panel in the Delivery workspace to access the

beam angle adjustment buttons . Click the buttons to adjust the UA beam angle in 1-degree increments in either clockwise  or counter-clockwise  directions, up to a maximum of 5 degrees in either direction. It is recommended to perform beam alignment near the start of treatment when the heating pattern from the UA is a developing narrow beam. As treatment progresses, since the UA rotates while delivering heat, previously heated tissue can still appear hot and make it difficult to identify where the heat is currently being delivered. As an example, *Figure 55* shows a UA beam angle that is offset from the heating pattern of the temperature map. Next, the beam angle adjustment buttons are used to rotate the UA beam angle back toward the center of the heating pattern. After the adjustment is complete, the UA beam angle is positioned more centrally within the heating pattern.



The UA is treating in the clockwise direction and the **Beam Alignment** buttons are used to adjust the beam angle in increments of 1 degree each time. The beam angle is now positioned more accurately as it

10. Treatment Delivery

the UA beam angle leads the heating pattern of the temperature map. time it is clicked. In this image the counter-clockwise button has been clicked 3 times to make a 3-degree adjustment.

is situated more centrally in the area where the heating pattern or temperature is highest.

Figure 55: Beam angle adjustment

10.f Delivery Paused

Radiologist: At any time during Delivery, click **Pause** in the bottom-right corner of the screen (see *Figure 50*). While in the paused state, all heating from the UA is suspended while thermometry acquisition continues (*Figure 56*).

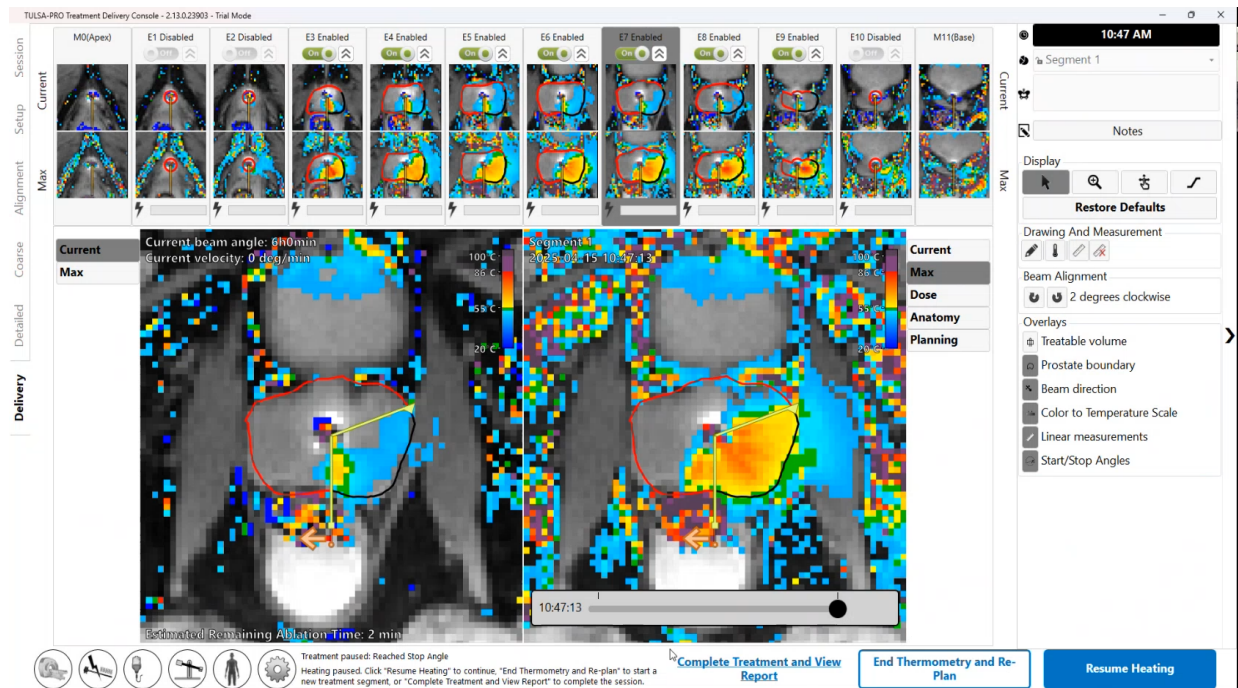

Figure 56: Delivery workspace with treatment and heating paused

Pausing treatment enables the following options:

- **Rotate the UA to a new position and/or change the direction of treatment rotation.** In some instances, you might want to set the UA to a new position and/or change the treatment rotation direction. To execute this command, follow the steps in the *Treatment Delivery* section and when the system is ready to resume treatment, click **Resume Heating**.
- **Edit the prostate boundaries.** In some instances, the patient anatomy may deviate from the originally planned target volume over time. Editing the prostate boundaries allows you to make minor changes to target volume to better reflect the current anatomy. See *Editing the Prostate Boundary during Treatment*.
- **Adjusting Treatable Volume Selection.** While paused, you can change the treatable volume using the drop-down at the bottom of the main viewport.

- **Adding or removing Start/Stop Angles in Delivery.** If you want to change the defined **Start/Stop** angles during Delivery:
 - pause the treatment, click the pencil icon, and adjust the angles as desired, OR disable the feature entirely by clicking the pencil button again in the **Drawing and Measurement** tools area. If the feature is disabled, the defined prostate treatment boundaries drawn in Detailed planning are re-validated to ensure the affected boundaries are valid.



NOTE:

- Gold boundary: valid boundary.
- Pink boundary: valid boundary and ultrasound will be directed to those areas, but they extend beyond the expected maximum treatable radius and thermal coagulation might fall short of the prostate boundary in those areas.
- Red boundary: area that is excluded from the target prostate volume, because it is too close to the UA.



NOTE: You can progress to **Treatment** if parts of the boundary are red, but the ultrasound will not be directed to those areas.

- Purple boundary: invalid boundary, because the boundary was drawn on a region with high temperature uncertainty.



NOTE: You cannot progress to **Treatment** if any part of the boundary is purple.

- Any boundaries that require review due to validation issues will have a magnifying glass (🔍) appear at the top of their viewport in the delivery window.
- **Start a new treatment segment.** In some instances, the temperature maps are no longer valid due to, for example, large motion artifacts. In such cases, you must end the current treatment segment by clicking the **End Thermometry and Re-plan** button. This will stop cooling of the UA and ECD; you can choose to wait up to 4 minutes before taking this step. After ending the segment, the TULSA-PRO® system enforces a minimum wait period of 20 minutes before heat delivery can resume, to allow for tissues to reach baseline temperature again. During this time, home the UA rotation, re-acquire planning images, and update the treatment plan before creating a new segment. See *Creating a new Treatment Segment* for more information.



During treatment delivery, if you see that the temperature maps are no longer valid (such as due to patient motion), you must end the treatment segment to acquire new reference images for MR thermometry.

- **Continue treatment delivery.** When you want to resume treatment delivery (such as after rotating the UA to a new position or editing the prostate boundaries), click the **Resume Heating** button to exit the Pause state and resume treatment in the Delivery state.
- **End the treatment.** When you are satisfied with the heat delivered to the target volume, click **Complete Treatment and View Report**. After pressing this button, the TULSA-PRO system will continue acquiring thermometry images and pumping cooling fluid through the UA and ECD during

the post-delivery cooldown period (which can last up to 4 minutes). Afterward, the TDC software will enter review mode, allowing you to review the previous workspaces (Setup, Alignment, Coarse Planning, Detailed Planning, and Delivery), but not the ability to unlock them for editing.

MRI Technologist: If the MRI is still acquiring thermometry images after the treatment segment and the post-delivery cooldown has ended in TDC, stop the current AX THERM scan on the MR console.



NOTE: Stopping the AX THERM scan on the MR console will interrupt treatment and the post-delivery cooldown.

10.g Editing the Prostate Boundary during Treatment

Radiologist: In some instances during treatment delivery, the patient anatomy may change from the originally planned target volume over time. For minor changes, the prostate boundaries can be modified while thermometry acquisition continues. To do this:

1. Pause the treatment delivery.
2. Once delivery is paused, expand the right panel in the Delivery workspace to select the prostate boundary drawing tool (*Figure 57*).

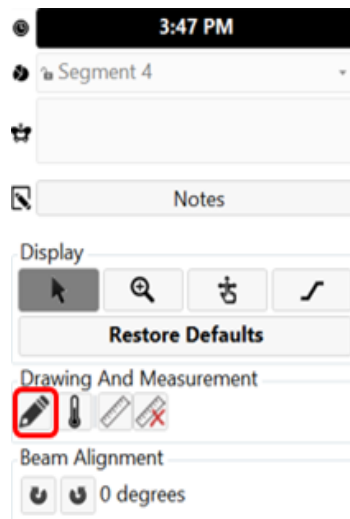

Figure 57: Prostate-boundary 'Drawing' tool on Delivery screen

3. Click the drawing tool. The TDC displays a new pane showing the prostate boundary contour and the temperature uncertainty for the selected slice (*Figure 58*).
4. Modify the boundary as needed on each slice. As with the thermometry uncertainty images in Detailed Planning, avoid drawing the boundary through high-temperature uncertainty regions.
5. If satisfied with the modified boundaries on all slices, click **Apply**. The TDC will validate the changes to the boundary and then you can click **Resume Heating** to resume treatment delivery. Otherwise, click **Discard Changes** to start editing from the current boundaries again. If none of

the changes are acceptable, then create a new treatment segment by clicking **End Thermometry and Re-plan**.

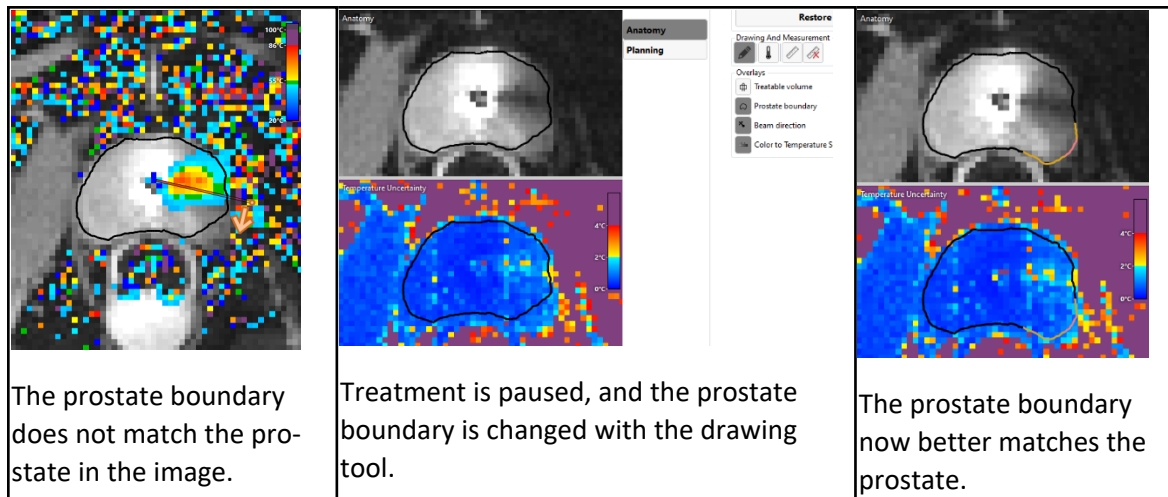

Figure 58: Editing the prostate boundary

10.h Creating a new Treatment Segment

Radiologist: Sometimes during treatment delivery, the current temperature maps may no longer be valid. In other words, temperature measurements near the target boundary are not accurate enough to deliver an effective treatment. This could be caused by large motion artifacts such as bulk patient motion, artifacts from uncleared bubbles between the ECD and rectal wall, or even motion of the rectum into planned target volume. Alternatively, it could be observed that heat is accumulating in unexpected regions (for example, in the wrong direction or on the wrong slices).

1. **Radiologist:** In these cases, you must recognize the situation and click **End Thermometry and Re-plan** to create a new treatment segment.



NOTE: Ending thermometry also turns off cooling of the UA and ECD.

After ending a treatment segment, wait a minimum period of 20 minutes is imposed to allow tissue temperatures to reach baseline again before initiating a new thermometry acquisition and resuming the delivery of heat. This is necessary because the current thermometry sequence will be interrupted and a new set of reference images (at baseline temperature) must be acquired.

2. **MRI Technologist:** If the MRI is still acquiring thermometry images after the treatment segment has been ended in TDC, stop the current AX THERM scan on the MR console.
3. **MRI Technologist:** Before re-acquiring treatment planning images, home the rotation of the ultrasound applicator so that it can be visualized correctly during re-planning. In the Setup workspace, click the Unlock button in the bottom right corner, and then click **Home** (🏠). The system will rotate the UA clockwise and counter-clockwise to find the home position of the UA, so that the UA window is facing downwards (6:00).

10. Treatment Delivery

4. **MRI Technologist:** Duplicate the MRI planning sequences into the queue and follow the instructions from that point in the workflow (from section *Checking Gross Device Positioning* through *Treatment Delivery*).
5. **Radiologist:** Repeat the instructions from *Checking Gross Device Positioning* through *Treatment Delivery*. For each step, ensure that a new set of images is being used to update the treatment plan. When the treatment re-planning is complete and at least 20 minutes has elapsed since the previous treatment segment was ended, proceed to *Treatment Initialization*.

10.i History Slider

Use the History Slider to display treatment images from previous timepoints in order to assess:

- patient motion and thermometry artifacts in the current treatment segment, and
- ablation coverage in previous segments.

The History Slider appears at the bottom of the right viewport in the Delivery workspace (*Figure 59*), and is accessible during live treatment delivery, when treatment is paused, and after treatment is completed.

To use the history slider:

1. Select the desired slice and display mode (Current Temperature, Maximum Temperature, Dose, Motion, or Anatomy).
2. Click-and-drag the History Slider until the desired timepoint is displayed on both the right viewport and the corresponding second row of thumbnail images.
3. Rapidly scroll through sequential images in either on Anatomy or Current Temperature view helps to identify the occurrence of gross patient motion and the movement of gas or stool in the rectum.
4. Scroll further to the left to see Maximum Temperature or Dose views, which help to assess ablation coverage from previous treatment segments.



NOTE: When viewing images from previous timepoints, a frame around the right viewport shows that the latest images are not being viewed (*Figure 60*). A dashed line shows where the beam angle was at the previous timepoint. To return to the current timepoint, click **See live** or drag the History Slider until the framed message disappears.

10. Treatment Delivery

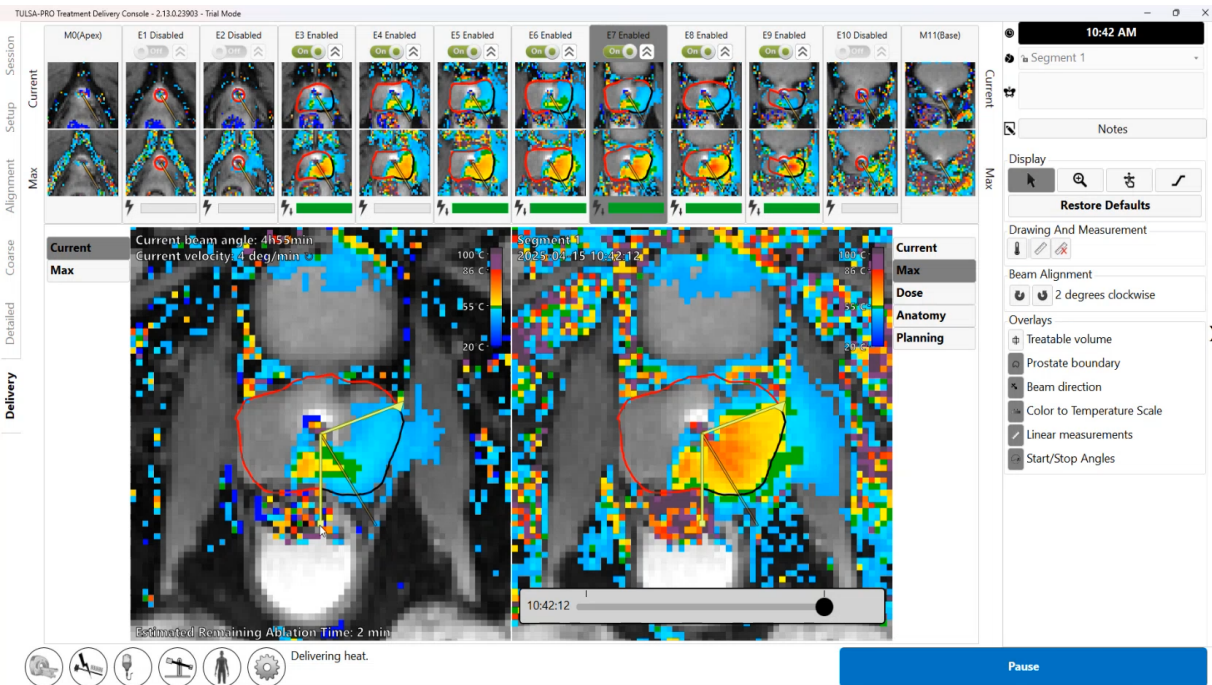

Figure 59: History slider in Delivery workspace

5. To return to the current dynamic, click **See Live** or drag the history slider until the message that reads “You are not viewing the latest image” disappears.



Figure 60: “You are not viewing the latest image” message below history slider

10.j Thermal Boost

Radiologist: If your TULSA-PRO installation includes the TULSA-AI Thermal Boost module, you can use it to optimize the reliability of heating to the target boundary.

Figure 1 shows the maximum temperature view in a case where Thermal Boost was applied on one slice and not on the other.

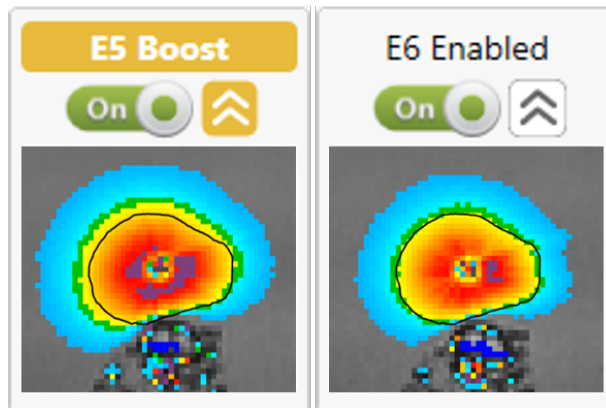

Figure 61: Max temperature maps of the same target boundary treated with boost (left) and without (right).



NOTE: Thermal Boost can help to ablate target tissue when a desired target boundary is invalid due to high thermometry uncertainty at the edge of the gland. In areas with invalid boundaries, reduce the target radius by 1-2 mm into areas of lower thermometry uncertainty, and then apply Thermal Boost during Delivery to achieve the intended ablation extent.



NOTE: Thermal Boost remains activated until turned off by the physician. Thermal Boost should not be used to heat important peri-prostatic anatomy such as the rectum, neurovascular bundles, external urinary sphincter, bladder wall, or pelvic bone. Targeting important peri-prostatic anatomy with Thermal Boost could result in thermal damage to structures outside the prostate, which could lead to treatment-related harms that may include rectal fistula, other bowel complications, erectile dysfunction, retrograde ejaculation, urinary incontinence, other urinary complications, or damage to the pelvic bone and/or nerves adjacent to the pelvic bone.

To boost an element during treatment:

1. Make sure the individual element is Enabled (switch is set to **On**). For example, in Figure 2, elements 5 to 9 are enabled.

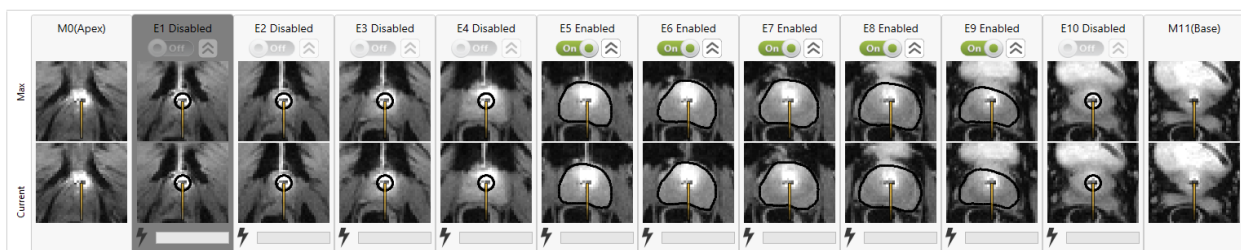

10. Treatment Delivery

Figure 62: Enabled elements

- Click on the double-chevron to activate **Boost**. When Boost is activated, the element's label will change from **Enabled** to **Boost**, its Boost icon will turn yellow, and the Thermal Boost control parameters will remain in effect for that element until deactivated. For example, in Figure 3, heating is Enabled on elements 5, 7, 8, 9, and Boost is activated on Element 5.

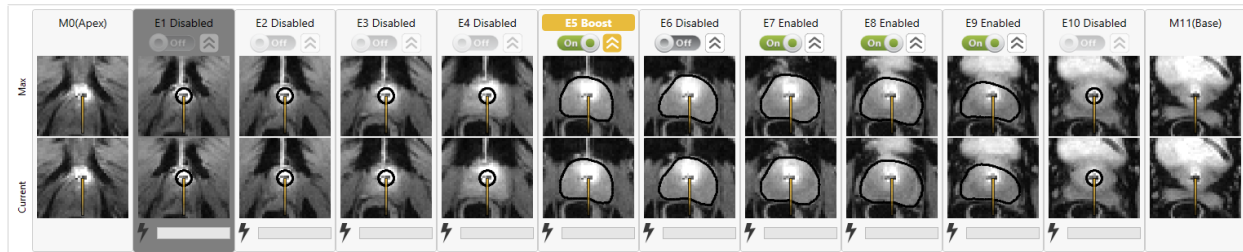

Figure 63: Thermal Boost enabled

- To disable Thermal Boost, click on the double-chevron again and the element will return to the default treatment delivery control parameters.

11. Post-Treatment Imaging and Reports

After the post-delivery cooldown period, the TDC software will advance to the *Reports* workspace where the MRI Technologist acquires post-treatment images, generates treatment reports, and exports treatment session data.

11.a Post-treatment Imaging

MRI Technologist: Acquire Contrast-Enhanced (CE)-MR images to evaluate the extent of acute thermal coagulation using the following steps from the MRI console:

1. In the MRI sequence protocol, open the AX T1 sequence.
2. Since AX T1 is on the same Geo as AX THERM, verify that the coordinates are the same in the Offc/Ang tab.
3. Click **OK** and run AX T1 pre.
4. After AX T1 pre is complete, inject contrast agent into patient under direction of the treating physician.
5. Approximately 2 minutes after injection, repeat steps 1-3 to acquire a matching set of post-contrast images (AX T1 post).
6. End the MRI exam.

11.b Entering Treatment Milestones

MRI Technologist: Use the Treatment Milestones panel in the *Reports* workspace (*Figure 64*) to record:

- The time when the Urologist removed the ultrasound applicator (UA), and
- The time when the patient was transferred from the MRI magnet room to the recovery area.

After saving each Treatment Milestone, the area will turn gray and the **Save** button will be replaced by **Edit**.

Recording these timepoints allows for better estimates of total procedure time and total anesthesia time.

11. Post-Treatment Imaging and Reports

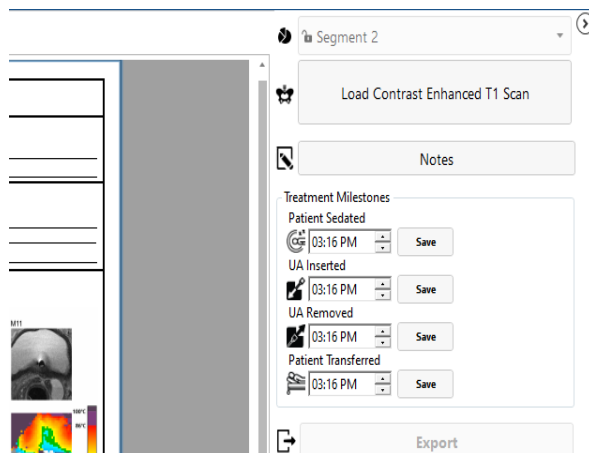

Figure 64: Treatment Milestones panel in Reports workspace

11.c Treatment Reports

When the Treatment Delivery Console (TDC) enters the *Reports* workspace, users see a brief summary of the treatment session (Figure 65). At the same time, the TDC starts to generate videos of the treatment, which might take several minutes.

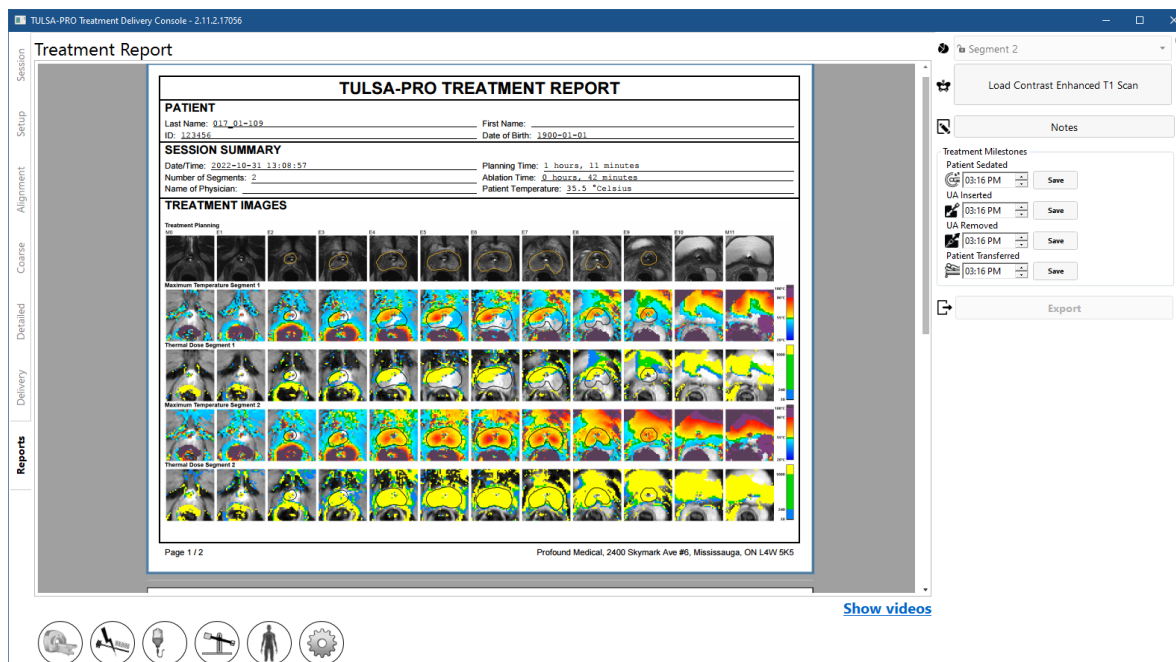

Figure 65: TDC Reports tab

The **PATIENT** section includes the patient's name, ID, and birthdate.

The **SESSION SUMMARY** gives an overview of the treatment performed, including:

11. Post-Treatment Imaging and Reports

- the session date and time
- the number of treatment segments (which will include any segments on which no treatment was performed)
- the physician's name (if entered for the MRI scans)
- an estimate of the total time spent on the treatment, separated into two timeframes:
 - **Ablation Time:** An estimate of time spent in treatment delivery, over all the segments.
 - **Planning Time:** The remainder of the time spent between the beginning of planning (alignment) and ending the treatment
 - the patient temperature at the start of the last segment treated.

The **TREATMENT IMAGES** section shows the AX T2 scan for each slice, as used for planning, followed by the maximum temperature observed in each treatment segment and the estimated thermal dose. If there was more than one treatment segment, there will be one series of maximum temperature images and thermal dose images for each segment.

The report also shows any **NOTES** made throughout the entire session.

From the **Reports** tab, you can import post-treatment, contrast-enhanced images to include in the report.



NOTE: The TDC can only import axial images and only within 12 hours after treatment.

MRI Technologist: To import images, follow the same instructions as Section *Pushing and loading planning images from the MRI to TDC*.

In the *Reports* workspace, you can review images by selecting the tab for any step of the treatment, including *Session*, *Setup*, *Alignment*, *Coarse Planning*, *Detailed Planning*, and *Delivery*. If you change the treatment notes on any tab, the treatment report will be updated with your changes.

You can also view the *Reports* workspace when reviewing old treatment sessions. The TDC software can generate a treatment report for sessions performed with previous versions of the software; however, some fields might not be shown for old sessions if the data was not saved.

11.c.i Viewing treatment videos

When TDC has finished generating the treatment videos, the [Show videos](#) link will be available at the bottom of the *Reports* workspace. Click [Show videos](#) and the report region of the display will show the treatment videos (*Figure 66*).

11. Post-Treatment Imaging and Reports



Figure 66: Treatment video displayed in Reports workspace

You can play (⏮) the video for the treatment segment (or if the session had multiple segments, use the segment selector (Figure 66) to choose an individual segment) and choose to see the anatomy with an overlay of the current temperature, maximum temperature, or thermal dose. Each video also shows the prostate boundary, the direction of the beam at each moment, and the intensity of heating.

11.c.ii Exporting reports and videos

You can also save the treatment report and videos to the computer hard drive or any storage medium. Attach the appropriate storage device and click **Export**. The system displays a window where you can choose a location to store the files and whether to export a PDF file of the report and videos with overlays (Thermal Dose, Maximum Temperature, Current Temperature, or Anatomy) (Figure 67).

As an option, you can exclude the patient's personal data from the PDF report to protect their privacy. To exclude patient data from the export, select **Anonymize patient data**.

11. Post-Treatment Imaging and Reports

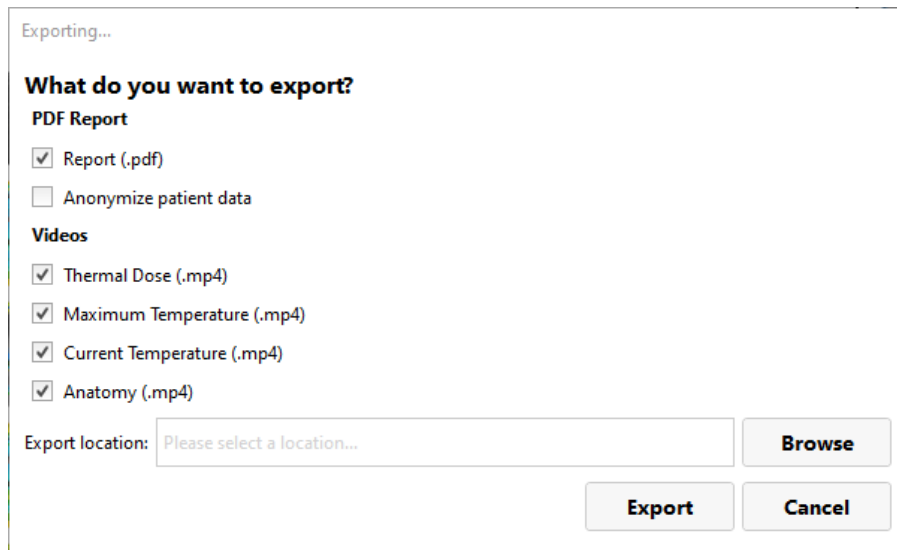

Figure 67: Exporting treatment session reports and videos

11.d Post-treatment Session Export

MRI Technologist: From the Treatment Delivery Console (TDC), you can export a patient's session data in order to:

- send session data to Profound Medical for help with troubleshooting problems
- back up the session information for future retrieval and use.

To export a patient session:

1. From the Start Screen, click **Manage Sessions**. Enter the login credentials (see *User Accounts*).
2. On the TDC **Manage Sessions** screen (Figure 68), select a treatment session and click **Export**.

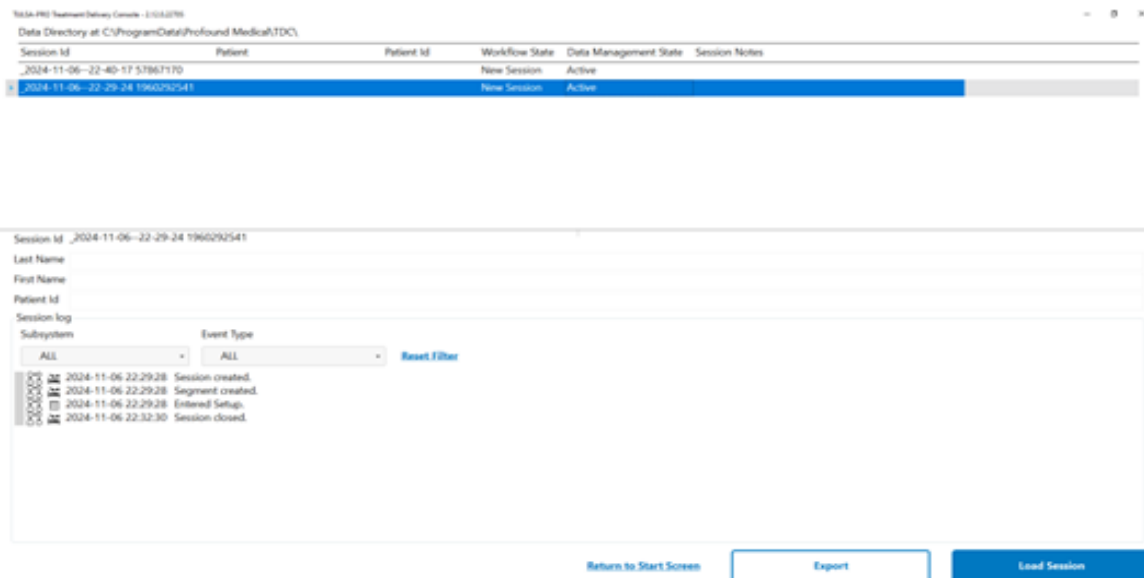
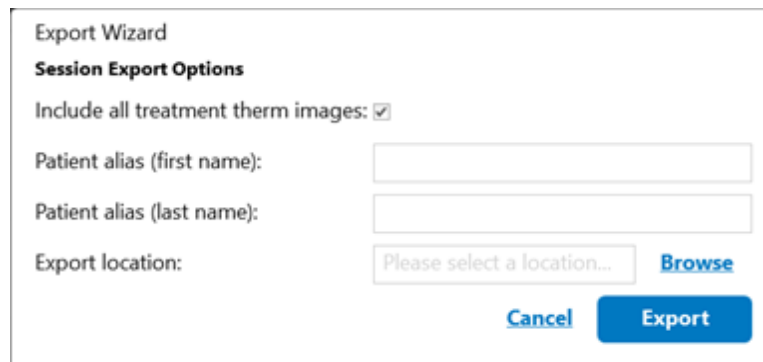

Figure 68: TDC Manage Sessions screen

3. The **Export Wizard** opens (Figure 69). Complete the **Session Export Options**:



The screenshot shows a dialog box titled "Export Wizard" with a sub-section "Session Export Options". It contains the following elements:

- A checked checkbox labeled "Include all treatment therm images:
- A text input field for "Patient alias (first name):"
- A text input field for "Patient alias (last name):"
- An "Export location:" section with a text input field containing "Please select a location..." and a blue "Browse" button to its right.
- At the bottom, there are two buttons: a blue "Cancel" button and a blue "Export" button.

Figure 69: Export Wizard

- i. You can export the session software logs and related data. In addition, you can export the temperature map images during treatment. To include images in the export, select **Include all treatment therm images**.
NOTE: If you do not select **Include all treatment therm images**, only the last image will be exported.
- ii. As an option, you can *anonymize*, or remove, the patient's personal data to protect his privacy. To exclude patient data from the export, select **Anonymize patient data**.
- iii. If you choose to anonymize patient data, you must enter:
 - **Session alias**, or reference name
 - **Patient alias (first name)**
 - **Patient alias (last name)**
- iv. Enter an **Export location** on your computer hard drive where you want to store the session data. Click **Browse** to find a folder where you want to store the session.
- v. Click **Export**.

12. Device Removal and Patient Recovery

After treatment and all post-treatment imaging is complete, the MRI technologist leads equipment dismantling, the Urologist removes the UA and ECD and examines the patient, and the Anesthesiologist recovers the patient.

12.a Device Disconnection

The following steps can be performed while waiting between contrast agent injection and acquisition of post-treatment contrast enhanced images, without moving the patient or the MRI table:

1. **MRI Technologist:** Switch off the System Electronics.
2. **MRI Technologist:** Disconnect the UA cable.
3. **MRI Technologist:** Close the line clamps on the UA and ECD tube sets near the UA and ECD.
4. **MRI Technologist:** Disconnect the fluid tube sets from the UA and ECD, taking care as some water might leak. Prevent further leaks on the UA, ECD, and tube sets by connecting their respective male and female fittings together.
5. **MRI Technologist:** Prepare a biohazard bag for disposing the UA and ECD as described in *Cleaning and Disposal*.
6. Pass tube sets back through the waveguide into the equipment room or control room.
7. Remove the tube sets from the System Cart and dispose as described in *Cleaning and Disposal*.

12.b Device Removal

The following steps are performed after all post-treatment imaging is complete:

1. **MRI Technologist:** Move the MRI table out of the magnet bore.
2. **MRI Technologist:** Withdraw saline from the ECD balloon using a syringe.
3. **MRI Technologist:** Without moving the patient, release the UA Clamp to detach the UA from the PS.
4. **Urologist:** Wearing sterile gloves, hold on to the UA handle while the MRI technologist moves the PS.
5. **MRI Technologist:** Unlock and lower the PS, then slide the PS back, away from the UA. Disconnect the PS, remove the PS and PSIB from the base plate, and place them on the work surface in the MRI magnet room.
6. **Urologist:** Remove the UA and ECD from the patient and place in the biohazard bag.
7. **MRI Technologist:** Detach and remove the anterior imaging coil and any straps placed around the patient.

12.c Patient Recovery

1. **MRI Technologist:** With help from the clinical team, transfer the patient from the MRI table to an MRI-compatible gurney or undock and use the transportable MRI table (site-specific).
2. **Urologist:** Examine the patient for any signs of positioning-related injury.
3. **Urologist:** If a supra-pubic catheter was used, it should be kept in place after treatment for a period of 1 to 4 weeks. If no supra-pubic catheter was used, insert a Foley catheter using sterile technique, to be kept in place for several days. Catheters (suprapubic or urethral) should only be removed after a successful voiding trial at the discretion of the prescribing physician.
4. **Anesthesiologist:** Transfer the patient to the patient preparation area and follow patient recovery procedures according to anesthesia standard of care.

12.d Equipment dismantling

1. **MRI Technologist:** Remove the base plate and patient pad.
2. If desired, copy or back up the MR images from the MRI console computer.
3. Terminate the MRI exam (close patient).
4. Turn off all the TULSA-PRO® equipment: shut down the TDC computer.
5. Coil up any disconnected cables, remove all TULSA-PRO® equipment from the MRI magnet room, and move the System Cart to its storage location. The Filter Box can be left in place, attached to the penetration panel. If for any reason the Filter Box needs to be removed, cover the opening in the penetration panel with the provided cover plate.
6. Wipe down the MR bed and clean TULSA-PRO equipment following the instructions in *Reusable Equipment Cleaning & Disinfection* and then store them in the designated storage case.

13. Cleaning and Disposal

13.a Disposables

The Ultrasound Applicator (UA) and Endorectal Cooling Device (ECD) will touch the patient during treatment and will be contaminated with body fluids.

13.a.i Ultrasound Applicator (UA)

- Wear gloves when handling a used UA to avoid contamination with body fluids.
- The UA is intended for single use only. Do not attempt to re-use the UA.
- Dispose in biohazard garbage.

13.a.ii Endorectal Cooling Device (ECD)

- Wear gloves when handling a used ECD to avoid contamination with body fluids.
- The ECD is intended for single use only. Do not attempt to re-use the ECD.
- Dispose in biohazard garbage.

13.a.iii Fluid Tubing

Fluid circuit tubing is designed for single use. Dispose of tubing in regular garbage. If any section of tubing is visibly soiled with body fluids, dispose in biohazard garbage.

13.b Reusable Equipment Cleaning & Disinfection

13.b.i General Cleaning and Disinfection

Reusable equipment should be cleaned thoroughly before the first use and after each patient treatment. Disinfect devices that come into contact with bodily fluids or that touch the patient's skin. After cleaning and/or disinfecting using the instructions in this section, visually inspect for cleanliness and repeat as required.

Other medical devices that are used along with TULSA-PRO should be cleaned based on manufacturer instructions.

The following equipment might contact intact skin and should be cleaned and disinfected after each patient use:

- Base Plate and Patient Pad
- Leg supports
- Straps

13. Cleaning and Disposal



NOTE: Dispose of straps if soiling occurs. Contact Profound Service for replacements.

The following equipment is not intended to contact intact skin and should be cleaned and disinfected after each patient use:

- Positioning System (PS)
- Positioning System Interface Box (PSIB)
- UA cable and PS cable

The following equipment will not become contaminated during use as they are located in an alternate room. Therefore, they do not need to be disinfected. However, wipe them down until visually clean to prevent dust and other debris from accumulating:

- System Cart and System Electronics
- other system cables
- TDC computer

13.b.ii General Cleaning Reagents, Methods, and Tools

Cleaning Reagents

TULSA-PRO components that are intended for reprocessing, excluding the computer, are compatible with only Cavicide wipes or solutions as cleaning and disinfection reagents. Profound Medical has not evaluated the use of other cleaning or disinfection reagents; avoid using them.



Do not use hydrogen peroxide based cleaners for cleaning, because they will corrode copper, zinc, and brass, which are present on the equipment.

Cleaning Tools and Methods

- Perform all cleaning using pre-wet wipes and/or a soft-bristled brush.
- Cavicide solution in a spray bottle is recommended for cleaning some components.
- Prepare all cleaning and disinfection agents according to manufacturer guidelines for water conditions and concentrations.
- Discard and replace straps, pads, and other components that become soiled and cannot be cleaned. Contact Profound Service to order replacement straps or pads.

Pre-cleaning Preparation

1. Ensure you put on all personal protective equipment recommended by the manufacturer of the cleaner.
2. Ensure there is a stable surface to work on and a separate clean area is available to place cleaned modules.
3. Ensure system is powered OFF.

13. Cleaning and Disposal

4. Immediately after use, wipe any visible soil or contaminants from the surfaces of these components using a damp cloth or cleaning wipe to prevent drying of contaminants.

If you must transport soiled components to a designated cleaning area, ensure individual closed containers are available to limit cross contamination.



Always wear gloves and other applicable personal protective equipment when cleaning the device and handling cleaning chemicals.



Do not use abrasive tools. Do not spray the cleaning reagents on the system components, modules, accessories, or peripherals unless directed.



No method of automated cleaning or disinfecting has been validated for the TULSA-PRO System. None of the reusable modules are sterilizable or autoclavable.



Power off and unplug the system before reprocessing. Ensure connectors and cable ends do not become wet. Allow all components to fully dry before re-powering.



Do not fully immerse any components in cleaning fluid unless directed.

13.b.iii Performing Manual Cleaning and Disinfection

This section covers the cleaning methods for:

- PSIB
- UA cable
- PS cable
- Patient pad
- Leg supports
- Straps

The methods for cleaning the Positioning System and base plate are described in "Positioning System – Cleaning and Disinfection Instructions" on the next page and "Base Plate – Cleaning and Disinfection Instructions" on page 91, respectively.

Steps:

1. Wipe the surfaces of each device using a disinfecting wipe to remove visible soil.
2. Wipe around cables, edges, cracks, crevices, corners, hard-to-reach areas.
3. Repeat steps 1 and 2 as necessary until all surfaces and hard-to-reach areas are visibly clean.

13. Cleaning and Disposal

4. Use a fresh disinfecting wipe to thoroughly wet all external surfaces of the device, ensuring all surface areas have been in contact with the wipe, and allow them to remain visibly wet for the manufacturer-specified contact time.
5. Complete a rinse set by wiping all surfaces with a lint-free cloth dampened with distilled water to remove cleaner residue.
6. Wipe the area with a dry, lint-free cloth. Ensure that the area is dry to the touch.
7. Allow devices to air dry before storing in designated storage cases.

13.b.iv Positioning System – Cleaning and Disinfection Instructions

Clean and disinfect all outer surfaces of the positioning system (PS) following the instructions in "Performing Manual Cleaning and Disinfection" on the previous page. Move the PS through all its ranges of motion to ensure all surfaces are reached. Disassemble the PS by following these steps:

1. Remove the PS from its notched base plate by partially unscrewing the thumbscrew located on the rear of the PS base and depressing the horizontal adjustment lever through the Z channel at the rear of the PS base (*Figure 70*).

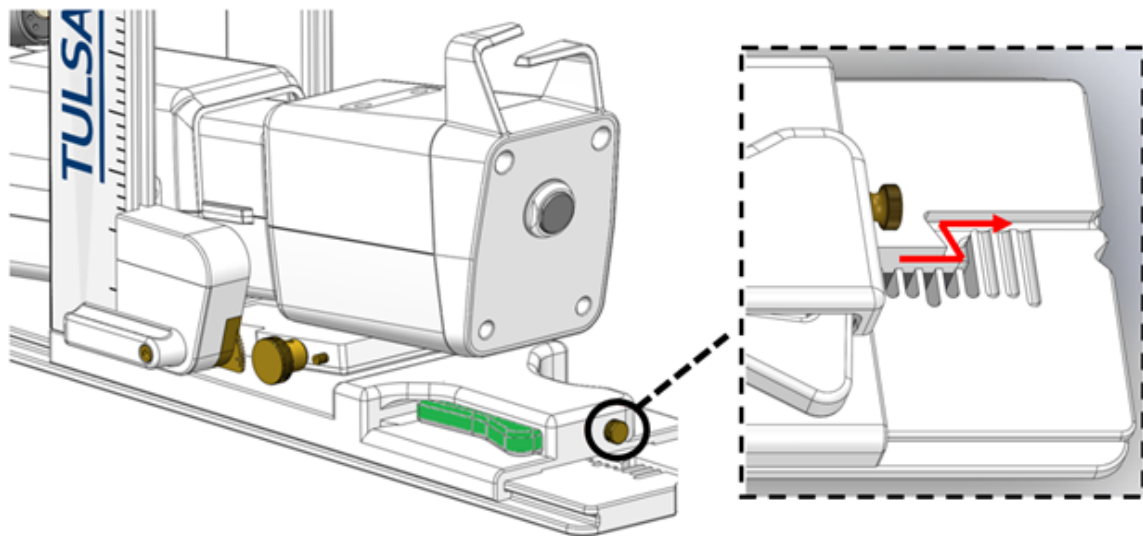

Figure 70: Removing PS from base plate

2. Detach the PS Nose by depressing the brass buttons.
3. If you see soiling in either the PS Base or PS Nose area, perform these steps:
 - a. Using a spray disinfectant, saturate the entire gripper area, focusing on the gear area or anywhere with visible soiling. Allow to remain wet for, at minimum, the manufacturer's specified contact time.
 - Ensure all edges, cracks, crevices, corners, and hard-to-reach areas are wetted with the spray disinfectant.
 - b. Use a wipe to loosen and brush away gross soil, then wipe all surfaces of gripper again using a fresh wipe.

13. Cleaning and Disposal

- c. Repeat steps 1 and 2 as necessary until no visible soiling remains, closely inspecting the areas around the gripper and gear (Figure 71).

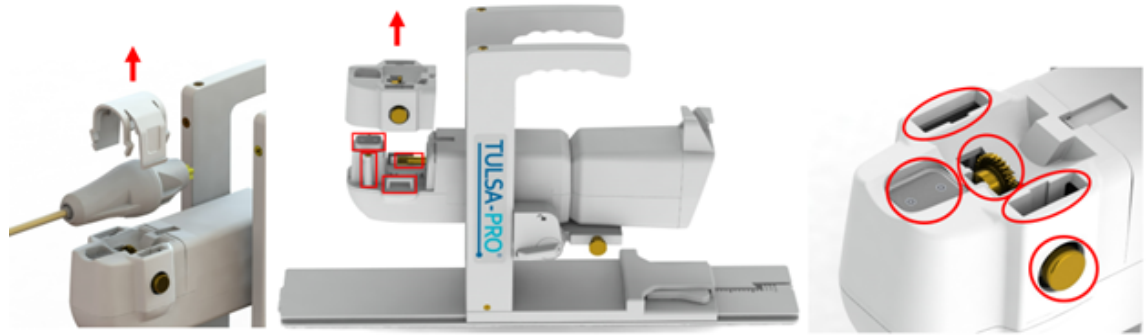

Figure 71: Inspecting the Positioning System

4. Once visually clean, use a fresh, disinfecting wipe to thoroughly wet all external surfaces, ensuring all surface areas have been in contact with the wipe, and allow to remain visibly wet for the manufacturer's specified contact time.
 - If necessary, use a pointed swab to access hard to reach areas.
5. Complete a rinse step by wiping all surfaces with a lint-free cloth, dampened with distilled water, and remove cleaner residue. Alternatively, rinse the UA mount by holding it above a basin and pouring water directly over the device and into the basin.
 - For any parts of the PS that might have contacted the patient's skin, repeat the rinse step a second time.
6. Allow the device to air dry. Ensure that the area is dry to the touch before re-attaching the PS nose component and subsequently storing or using the device in a procedure.
7. If soiling cannot be removed through this cleaning procedure, contact Profound Service.

13.b.v Base Plate – Cleaning and Disinfection Instructions

Clean and disinfect the easily accessible surfaces of the Base Plate following the instructions in "Performing Manual Cleaning and Disinfection" on page 89. For any grooves, recesses, or hard to reach areas, such as the leg support rails, latch, or handles, follow these steps:

1. Using a spray disinfectant, saturate any recesses, grooves, or areas that contain soiling. Focus on areas like the leg support rails, strap attachment points, the PS latch, and any edges or grooves. Allow to remain wet for the minimum manufacturer specified contact time.
2. Wipe inside the recesses and grooves that were sprayed with a disinfecting wipe to remove gross soil and absorb disinfectant.
 - If necessary, use a pointed swab to access hard to reach areas.
3. Repeat steps 1 and 2 as necessary until no visible soiling remains, closely inspecting all hard-to-reach areas. Use a soft bristle brush to loosen or brush away remaining soil.

13. Cleaning and Disposal

4. Once visually clean, perform a final wipe of all surfaces, recesses, and grooves of the base plate ensuring surfaces remain visibly wet for the manufacturer's recommended contact time.
5. Complete a rinse step by wiping all surfaces with a lint-free cloth, dampened with distilled water, and remove cleaner residue.
 - For any parts of the Base Plate that might have contacted the patient's skin, repeat the rinse step a second time.
6. Allow the device to air dry before storage or subsequent use in a procedure.

14. Software Alarms

14.a Alarm Indicators

An area at the bottom-left of the Treatment Delivery Console (TDC) screen shows alarm indicators when a session is in progress (Figure 72).

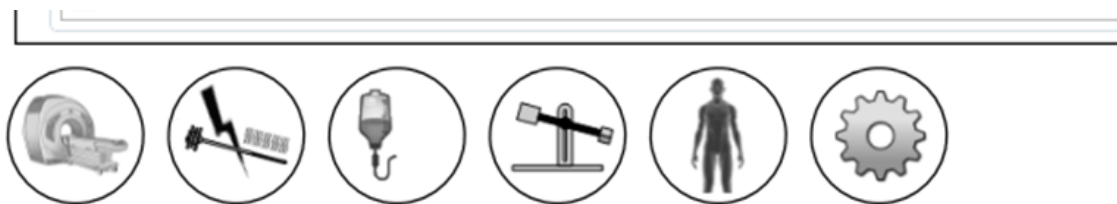



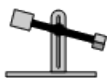



Figure 72: Alarm indicators (all indicators are clear)

The following table lists and describes the alarm indicators:

Table 1: Alarm indicators

INDICATOR	ALARM AND INFORMATION RELATED TO...	ALARM CLASSIFICATION
	...communications with and functionality of the connected MRI system, or to show there is no MRI connected.	Technical
	...the Radio Frequency circuit.	Technical
	...Fluid Circuits.	Technical
	...the Positioning System (PS).	Technical
	...the state of the MRI field of view relating to observed and predicted temperatures in the patient's treated region.	Physiological

INDICATOR	ALARM AND INFORMATION RELATED TO...	ALARM CLASSIFICATION
	...the state of the Treatment Delivery Console (TDC) computer.	Technical

14.b Description of Alarm Conditions

Though the TDC software has five indicators associated with distinct hardware components and a single indicator associated with physiological parameters of the patient under treatment, each indicator can have multiple conditions classified as *information* or *warning*.

An **information condition** happens when the corresponding subsystem detects a minor deviation from normal functionality. Information conditions do not affect normal setup, planning, or treatment workflow of TDC; they only draw attention to a potential problem.

A **warning condition** happens when there is a major deviation in a hardware or physiological parameter, which requires quick intervention. Depending on the condition and current system workflow state, a warning condition can affect normal TDC workflow.

Each information and warning condition has an error code, which is shown at the end of the error message displayed on the TDC. The *Appendix, Troubleshooting Guide*, provides detailed specifications of warning conditions, their delays, effects on TDC workflow, and troubleshooting tips. The TDC warning messages show the error code with a hyperlink; click on the link to open the related troubleshooting section in the Appendix.

If there is no information or warning condition associated with a subsystem, the corresponding subsystem alarm indicator stays clear (*Figure 72*).

If a subsystem detects an **information** condition, the background color of the corresponding indicator changes to **light blue** and an additional icon (i) is shown at the top-right of the indicator (*Figure 73*).



Figure 73: Example of Information condition

When a subsystem detects a **warning** level condition, the background color of the corresponding indicator changes to **orange** and an additional icon (!) is shown at the top-right of the indicator (*Example of Warning condition*).

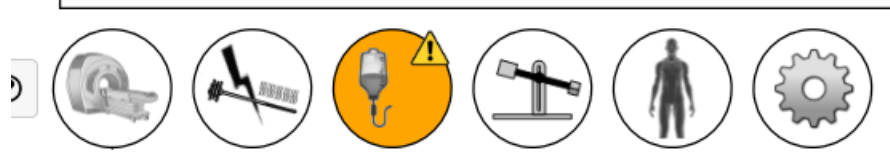

Figure 74: Example of Warning condition

Both Information and Warning level conditions detected by TDC are *Non-Latching*, which means the condition indicator will clear once the corresponding problem is fixed. However, the condition indicator will show its message for 10 seconds, even if the problem is fixed during that time. For example, if the system detects abnormally high pressure in a fluid circuit caused by a physical flow obstruction, the system shows the corresponding fluid circuit alarm. As soon as you remove the obstruction and the system detects pressure normalization, the alarm indicator returns to a normal, or clear, state.



NOTE: Though operators do not need to interact with the TDC software to clear the alarm and corresponding condition, you might need to return the TDC system to normal workflow. If the scenario discussed above happened during Treatment Delivery, the system would stop Ultrasound Applicator (UA) rotation and heat. After clearing the flow obstruction, the alarm will clear, but heat and rotation **will not start** until you click **Resume Heating** on TDC.

In addition to a change in the background color of an alarm indicator, a pop-up message containing details shows beside the indicator (*Example of message with Alarm condition details*). The message stays on the screen for 10 seconds. To see the pop-up message again, hover the cursor over the alarm indicator.

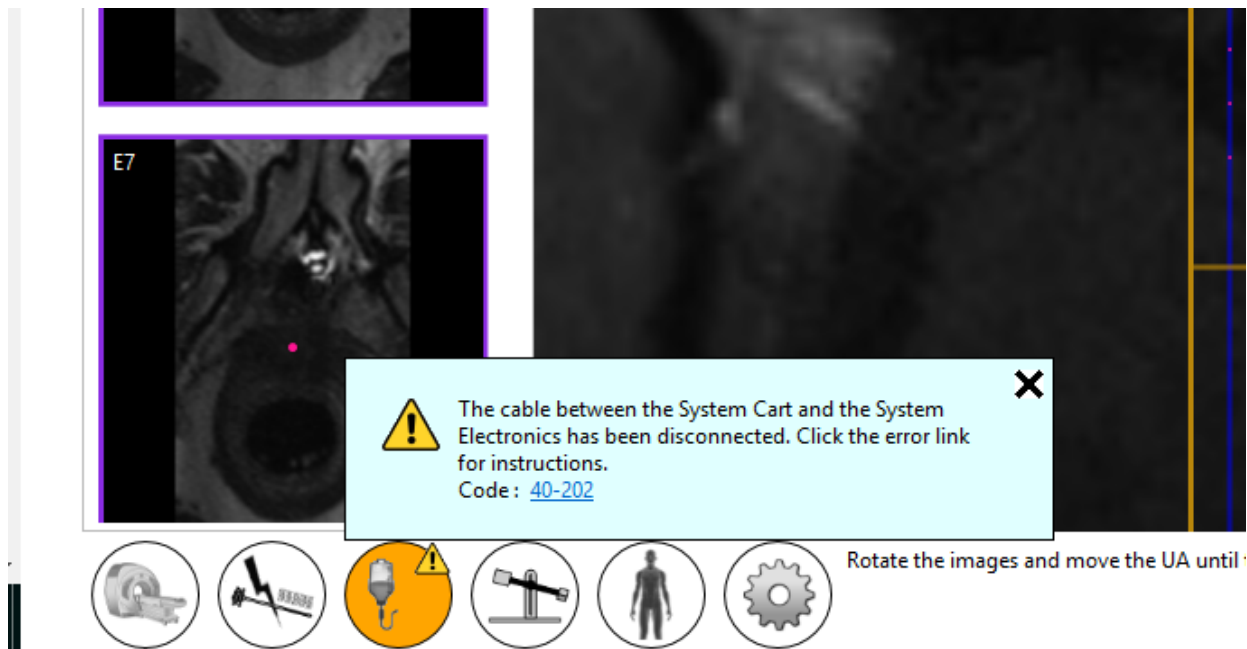





Figure 75: Example of message with Alarm condition details

14.c Multiple Alarm Conditions

A subsystem might detect multiple information-level and warning-level conditions. The following table describes the behaviour of the subsystem alarm indicator depending on condition levels.

Table 2: Example of multiple subsystem conditions

SUBSYSTEM CONNECTED	AT LEAST ONE WARNING-LEVEL CONDITION PRESENT	AT LEAST ONE INFORMATION-LEVEL CONDITION PRESENT	BACKGROUND OF THE INDICATOR	STATUS ICON
Yes	No	No	Default system	No icon
Yes	No	Yes	Light Blue	
Yes	Yes	No	Orange	
Yes	Yes	Yes	Orange	

The corresponding subsystem pop-up message will contain all condition messages (*Multiple condition messages in the pop-up message*).

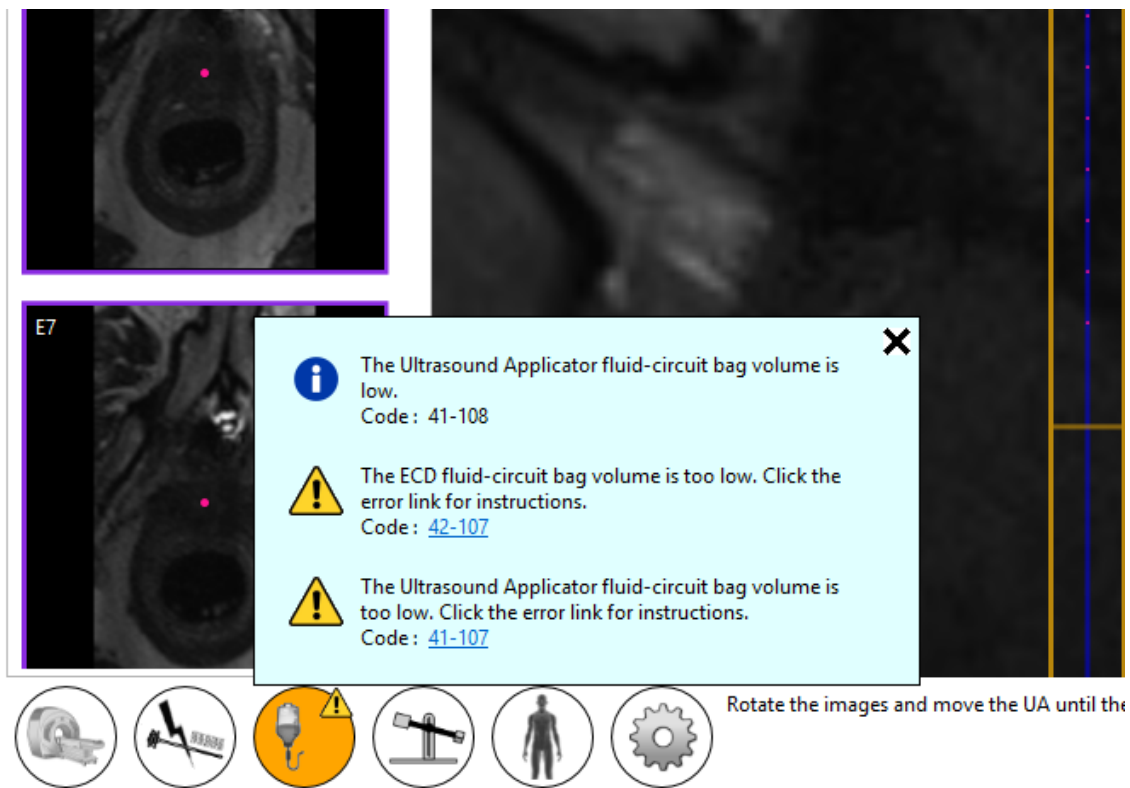

Figure 76: Multiple condition messages in the pop-up message

14.d Alarm Condition Log

Each warning or information condition detected in a session is registered in the session's Audit Log and can be reviewed any time during the session by switching to the *Session* workspace. You can see the conditions of each remote hardware subsystem (MRI, RF, FC and PS) individually by switching to the *Setup* workspace at any time during the session. The conditions will be shown in the corresponding subsystem log.



NOTE: The host-system hard drive creates an audit log when the session is created and will record new entries when any warning or information condition is detected for any subsystem.

The session's Audit Log is stored directly on the host-system's hard drive. There are no limits on the size of an Audit Log file. Audit Logs will continue to be created and updated on the host-system hard drive until there is no remaining storage capacity.



NOTE: A treatment delivery will pause if there is less than 6GiB of hard-drive storage remaining. An information message will display when there is 14.7GiB of hard-drive storage remaining.

When the operator exits the TDC application, the session's Audit Log will record this event.

When the system is powered down while the TDC software is running or powered down abruptly, such as during a total power loss, the session's Audit Log will not record the event. Events generated within the last few seconds of operation before losing power might also not be recorded.



NOTE: The Windows event log typically records a loss of power event.

15. User Accounts

To safeguard patient data and privacy, users must enter login credentials when accessing parts of the TULSA software that contain patient information.

15.a Login During Treatment

Creating a new session and performing equipment setup does not require entering a username or password. However, login by an Operator account is required when:

- loading the first set of patient images from the MRI to the TULSA software and moving from **Setup to Alignment**,
- re-entering the treatment software after closing it or having the screen lock due to inactivity, or
- accessing the **Manage Sessions** workspace from the Start Screen.

If it is the first time you are logging in using a password assigned to you by Profound or a local Administrator, you will be prompted to change your temporary password to a permanent one. You can also change your password at any time by accessing **Settings** from the Start Screen.

15.b Account Management

Representatives from Profound will create at least one account for an Administrator who can:

- operate the system,
- manage other Operator and Administrator accounts, and
- customize local settings including password complexity policies.

From **Settings** on the Start Screen, Administrator accounts can:

- Add Users, either with or without Administrator privileges.
- Disable and enable User accounts.
- **Reset Password** for other accounts, prompting users to create a new password the next time they log in.
- Configure policies defining the complexity of user passwords based on local security policy.
- Manually change the TULSA software **Date** and **Time** to synchronize with the MRI scanner.
- Set policies for password expiration, data retention, screen locking, and session closing.
- Configure Report Settings that will appear on all TULSA-PRO treatment reports.



If all Operator and Administrator accounts lose their passwords, an Emergency Security Reset may need to be performed by representatives of Profound. This will cause the deletion of all user accounts, and the loss of all protected health information from past treatment sessions.

Appendix A. TULSA-PRO® MRI Troubleshooting Tips

Patient motion concerns

The MR Thermometry of the prostate is adversely affected by any motion. Here are the motions of concern and how to address them:

MOTION CONCERN	TO ADDRESS THIS CONCERN...
Respiratory	Tightly strap the coils down.
Pulsation of vessels or arteries	Reposition the patient to change the angle or location of the vessel or artery.
Bladder filling	Install a supra-pubic catheter into the patient before treatment.
Fecal build-up	Ensure the patient follows a pre-treatment bowel preparation.
Peristalsis	Administer anti-spasmodic drugs to the patient.
Passing of gas	

Thermometry and temperature uncertainty

To adequately display temperature changes in the prostate, the tissue must be non-moving and show a low fat-to-water ratio. Also, the signal-to-noise ratio must be high enough in the regions of interest or the temperature in the MR thermometry images could be assessed incorrectly. Use the MR thermometry temperature-uncertainty map during treatment planning to assist in selecting regions of sufficiently high signal.

1. Fat protons do not contribute to changing the MR thermal signal. Therefore, the MR thermometry sequence uses a fat saturation technique, which is specified in the MR protocol. Consequently, TULSA-PRO® cannot measure the temperature in regions outside of the prostate that are made up of mostly fatty tissue.
2. Incorrect temperature measurements can be caused by an absence of MR thermometry signal, image distortions due to magnetic field variations, or other artifacts. The TDC software monitors the temperature during Treatment Planning and during Treatment. If temperature uncertainty measurements are outside the acceptable range during the validation of target boundaries, an error will show when you define the target boundary during Planning or when you change the target boundary during Treatment.
3. Temperatures within an MR thermometry voxel (in-plane resolution and slice thickness) are averaged. The MR thermometry spatial resolution is carefully selected to ensure accurate temperature measurements. The MRI Protocol specifies a resolution of $2 \times 2 \text{mm}^2$ in-plane and a slice thickness of 4mm.

4. Temperature changes are integrated over the MR thermometry image acquisition time. To ensure accurate temperature measurements, the MR Protocol specifies the image acquisition time, which can range from 5 to 6.5 seconds.
5. Ultrasound heating in the presence of large cysts and calcifications has not been validated using the TULSA-PRO®. Do not treat patients with the TULSA-PRO® System if they have cysts or calcifications within the target prostate tissue volume that are larger than 1 cm.

You can treat prostates with smaller cysts or calcifications if these structures are in the interior of the gland and not at the periphery where temperature feedback measurements are calculated. Be careful and vigilant when treating tissue near these abnormalities.

Access to User Documentation from TDC

On any TDC screen and during any step—except during Treatment Delivery—you can press F1 on your keyboard to open and review the *TULSA-PRO® Operator's Manual*. Click **X** in the top corner to close the document window.

Appendix B. MRI Technologist Checklist for Philips

EQUIPMENT SETUP

B.0.i Inside the MRI magnet room

- Set up the TULSA-PRO base plate, coil holder/patient pads, and straps on the MRI bed.
- Prepare a work surface and connect the Positioning System Interface Box (PSIB) to the Filter Box and Positioning System (PS).

B.0.ii Outside the MRI magnet room

- Locate the 2x 1L sterile water bags and TULSA treatment kit from their storage location to prepare the devices outside the magnet at the system cart.
- If the System Cart is not permanently stored near the waveguide and connected to the System Electronics (SE), move it to the designed location near the end cable that allows connection to the SE, ensure the cable is connected, and raise the system cart pole.
- Remove the Ultrasound Applicator (UA) tube set (identified with a red dot) from its packaging, lose the line clamps, and lay the empty UA reservoir bag on top of the Fluid Circuit tabletop.
- Repeat for the Endorectal Cooling Device (ECD) tube set.
- Transfer 1L of sterile water to the reservoir bag on the UA tube set.
- While the UA bag is filling, inject the ECD supplements (Manganese Chloride and Span & Tween) into the other 1L sterile water bag and shake until it looks milky white
- Transfer 1L doped sterile water to the ECD tube set.
- When all the contents from the UA and ECD IV bags have been transferred to reservoir bags, close the line clamp to the sterile water bags.
- For each tube set, hang the reservoir bag on the corresponding color-coded weight sensor hook.
- Place the pump section of each tube set into the corresponding pump head and close it.
- Connect the pressure sensor to the corresponding connection on the System Cart.
- Pass the UA and ECD tube sets (capped ends) through the waveguide into the MRI magnet room.
- Turn the power switch on at the back of the System Electronics enclosure.
- Power on the TULSA computer and launch the Treatment Delivery Console (TDC) software.
- After accepting **Click Sync**, the start screen will appear. Click **Create New Session**.
- Register a new patient on the MRI console and load TULSA-PRO sequence protocol.

- In the MR Console taskbar, ensure that Access-I is connected by checking for a green checkmark in the Access-I icon. If there is a red **X**, click the icon once to enable the connection.
- Confirm a green checkmark appeared on the TULSA computer **Setup** in all quadrants.
- On the lower right quadrant click **TURN ON** under PSIB Display.

B.O.iii Inside the MRI magnet room

- Wearing clean gloves, open the top white paper of the UA packaging and connect the UA tubeset to the UA device tubing—red to red, white to white—, then open the clamps, shift them away from the device, and pinch to open the tube.
- Open the plastic cover of the ECD device and connect the ECD tubeset to the ECD device tubing—blue to blue, yellow to yellow—, then open the clamps.
- On the PSIB display, select the **PS** tab and, after making sure the PS can move freely, click **Test PS**.
- While the PS test is running, choose the Fluid Circuit tab on the PSIB display and purge the UA and ECD.
- Verify all air bubbles are eliminated from the UA and ECD. Continue tapping the device and turning on an off fluid circuit as needed after purge, until all air bubbles are removed. Check devices for leakage.
- Connect the UA and PSIB and perform **RF Connectivity Test** on the RF tab.
- Turn both pumps back on and disconnect cables from the UA and PS to prepare for moving equipment to the MRI table.
- Communicate with the anesthesiologist and physicians that electrical setup is concluded, and they can prepare the patient for sedation.

Prepare the ECD lubricant channels by:

- Connect a three-way stopcock and the syringe adapter to both the green and black-labeled channels.
- Connect low-viscosity lubricant syringes to the syringe adapters and prime the stopcock by pushing a small amount of gel and any air out through the side of the stopcock.
- Slowly inject 15mL of low-viscosity lubricant through the green channel while gently pressing on the pores closest to the handle to allow lubricant to fill in the small pores at the tip.
- If needed, inject another syringe to ensure that lubricant emerges without bubbles from all the pores.
- Repeat this process for the black-labeled channel.
- Connect an empty 30ml syringe to the green channel and a syringe with remaining lubricant (or a new one if not applicable) to the black channel.
- Connect a 30mL syringe with saline/sterile water to the ECD balloon channel (the thinnest line).

- If the patient's baseline temperature will be measured with a fiber-optic probe, place the disposable cover on the temperature fiber optic probe at the patient monitor.
- Place all required supplies for patient positioning and device insertion near the MRI bed (such as pillowcases and towels to protect skin from straps, blue chucks, extra low viscosity gel for digital rectal exam prior to ECD insertion). Arrange devices in order of transfer to the patient bed: ECD, UA, PS, PSIB. Ensure tubing and cables are organized for ease of transfer.
- If assisting with the sterile field setup falls within your responsibilities, proceed to that step.

Initial Patient Positioning

- If patient sedation is not performed on the MRI bed, transfer the patient into the MRI magnet room using an MR-compatible gurney.
- Position the patient on the MRI bed in a head-first supine position so that their sagittal midline is centered from left to right on the MRI table.
- Have an assistant lift the patient's legs one at a time while you set up the leg supports, and place a pillowcase or towel between the straps and patient skin.
- Provide the patient with ear protection to protect against MRI-related hearing injury.

Device Insertion

- Place an absorbent pad on the base plate between the patient's legs before device insertion.
- Provide low-viscosity lubricant to physicians so they can perform a digital rectal exam.
- Assist physician with ECD insertion and balloon inflation after device is inserted. Start with 15-20 cc and confirm with physician if additional fluid is needed. Disconnect syringe after balloon inflation.
- Arrange the ECD tube set cooling lines and ECD lubricant channel lines on opposite sides of the patient, to minimize ECD movement during treatment.
- When the physician is ready to insert the UA, without touching the UA to maintain sterility, detach the yellow cap (storing for later use).
If the physician chooses to not use a wire, skip this step.
- Remove the plastic cover enclosing the UA in the package.
- While holding the UA packaging tray by the long edges of its perimeter, flex the tray to release the UA from its snap features and present it to the physician.
- If needed, provide gel to the physician. Hold the UA tube set to avoid extra weight on the UA during insertion.
- Once the physician has inserted the UA, bring the PS and PSIB over to the MR table and position into place.
- While the physician holds the UA handle with the UA positioned at a natural angle in the patient, clip the PS into place on the base plate.

- Manually move the PS into position so that the UA gripper aligns with the natural angle of the UA in the patient. Manually adjust the PS forward and backward, up and down, taking guidance from the physician.
- Once the physician has seated the UA in the PS nose, place a hand under the nose to support it and secure the UA by pressing the UA clamp down over top of the UA until it is fully engaged with the PS nose. Engage the PS lock to fix the PS into place. Thread the UA cable and UA tube set through the cable management arms on the top of the PS with minimal tangling or twisting of the cables.
- Connect the yellow cap to the hub of the guidewire channel at the back of the UA handle, if it was removed.
- Reconnect cables from the PSIB to the UA and PS.
- Proactively remove any gas bubbles from the ECD using the empty syringe connected to the green channel.

MRI Patient Positioning

- Fasten one strap tightly over the lower abdomen under the patient's arms to minimize breathing motion.
- Fasten a second strap over the arms to help fit the patient into the MRI bore.
- Strap the anterior imaging coil over the patient's pelvis and arms. The coil should cover the prostate in line with the top of the patient's femoral heads, without interfering with the travel of the Positioning System.
- In the PS tab of the PSIB display, click **Home** to ensure the device can rotate freely. If it fails, ensure the UA is properly connected to the PS and patient is well-centered in the MRI bed.
- Use tube-and-cable straps to manage fluid tubes and the white RF cable.
- Ensure no cables, tubing, or other materials can be caught while the MRI table is moving.
- Landmark to the patient prostate and push the MRI bed into the bore.

Treatment Planning

- At the MRI console, check that the appropriate anterior and posterior coils are connected, and then run the Localizer scan to confirm initial device positioning.
- After physicians evaluate the Localizer scan, if they determine a need to adjust the devices, move the MRI patient table out of the bore far enough for the physician to adjust the devices.
- Run the SAG T1 scan to confirm there are no air bubbles in or around the UA and ECD.
- Once the physician is satisfied with the gross positioning of the ECD, acquire the SAG T2 3D sequence centered to the prostate and UA, and then push the images to the TULSA computer DICOM node.
- While the physician performs the UA alignment on the TULSA computer, acquire the SAG SWI scan. Several output scans will be created automatically. Send the sagittal SWI output to the TULSA computer DICOM node.

- Ask the physician if the UA has been moved during coarse planning. If so, acquire a new SAG T2 3D scan and push to the TULSA computer DICOM node.
- Open the AX THERM sequence for editing in the **Offc/Ang** tab, change the AP, RL, and FH values for both Stack Offc. and Ang to match those in the TULSA computer. Do the same for the shim volume.
- In the top menu on the MRI console, select **Examinations > Repeat Prescans**. Run the sequence.
- Prescribe and run the AX T2 and AX DWI sequences and then push the images to the TULSA DICOM node.

Delivery

- Once instructed by the physician, prepare the long AX THERM sequence for treatment.
- Duplicate the AX THERM sequence on the MRI console. In the **Dyn/Ang** tab, increase the number of dyn scans to the maximum allowed value or as instructed by the physician.
- In the top menu on the MRI console, select **Examinations > Repeat Prescans**.
- Do not run the scan until instructed by the physician.
- If replanning is required due to patient motion or other events leading the physician to start a new segment:
 - Acquire a new SAG T2 3D scan.
 - Repeat all required planning steps through Delivery.
 - Confirm with the physician whether optional SAG SWI and AX DWI scans will be needed for replanning.
- Once the physician informs you that treatment has ended, stop the current AX THERM scan.

Post-Treatment Imaging

- In the MRI sequence protocol, open the AX T1 sequence. Since AX T1 is on the same Geo as AX THERM, verify that the coordinates are the same in the **Offc/Ang** tab.
- Click **OK** and run AX T1 pre.
- After AX T1 pre is complete, inject contrast agent into patient under direction of the treating physician.
- Approximately 2 minutes after injection, repeat the previous steps to acquire a matching set of post-contrast images (AX T1 post).
- End the MRI exam and send all images except AX THERM to PACS.

Device Removal and Patient Recovery

- Switch off the System Electronics.
- Move the MRI table out of the magnet bore.
- Disconnect the UA and PS cables, and move the PSIB to the surface used to prepare the devices.

- Close the line clamps on the UA and ECD tube sets and disconnect the fluid tube sets from both devices. Connect loose ends on the device together to avoid leakage of cooling fluid.
- Withdraw saline from the ECD balloon using a syringe.
- Without moving the patient, release the UA Clamp to detach the UA from the PS.
- While physician holds the UA handle, unlock and lower the PS, then slide the PS back, away from the UA.
- Detach and remove the anterior imaging coil and any straps placed around the patient.
- With help from the clinical team, transfer the patient from the MRI table to an MRI-compatible gurney.

Cleaning and Disposal

- Wipe down the MR bed and clean TULSA-PRO equipment thoroughly after each patient treatment.
- Disinfect devices that come into contact with bodily fluids or that touch the patient's skin.
- Dispose UA and ECD in biohazard bag and fluid tubing in regular garbage.

Appendix C. Troubleshooting Guide

Symptoms, Causes, and Solutions

Use these symptoms, causes, and solutions to troubleshoot possible issues while operating the TULSA-PRO® system.

TDC Step	Symptom	Cause	Solution
Setup (Access-I)	Treatment Delivery Console (TDC) does not connect to MRI console	Access-I is not enabled on the MR console.	<ul style="list-style-type: none"> Enable Access-I on the MR console by clicking on the icon in the task bar. 
Detailed planning	The AX THERM does not load into the TDC with the alarm, "Incorrect position/orientation"	The acquisition of the AX THERM image was not at the expected position or orientation, as defined by the UA overlay in the TDC.	<ul style="list-style-type: none"> Ensure the sequence position or orientation has been updated and matches the one shown on the TDC position or orientation pane. Check that the table position mode of the AX T2/ AX THERM sequence is set to FIX and the table position is copied from the SAG T2 scan.
Detailed planning	The AX THERM scan does not load into TDC with the alarm, "The thermometry scan parameters are not within an acceptable range"	Upon receiving the AX THERM scan, TDC validates the parameters used during the scan acquisition. If any parameter falls out of range, this alarm is triggered.	<ul style="list-style-type: none"> Check the phase encoding direction. It should read A >> P. If not, click the ellipsis button (...) and change from -180 degrees to 0 degrees If the above solution does not work, retrieve the original AX THERM from the MRI sequence protocol, and try again.
Delivery	Less than 90 minutes of continuous imaging time is available	There is a limited amount of memory on the MR system, which limits the total number of dynamics that can be acquired.	<ul style="list-style-type: none"> The number of dynamics that can be acquired is dictated by the number of selected coil elements. To increase the number of dynamics, decrease the number of coil elements on the AX THERM sequence while maintaining good image quality. <ul style="list-style-type: none"> Open the AX THERM sequence and deselect the coil element that is the farthest from the center of the field of view. After disabling the element, observe the maximum number of dynamics. Disable as many elements as required to reach at least 90 minutes of continuous imaging time. Now that the coil selection has been changed, a new reference AX THERM sequence must be acquired. <ul style="list-style-type: none"> In the tab Contrast > Dynamic, set the number of measurements to 1. Run the sequence. With the new coil configuration, the thermometry uncertainty must be performed again. <ul style="list-style-type: none"> In TDC, unlock to the Detailed Planning

workspace.

- On the MR console, duplicate the new reference AX THERM sequence and in the tab **Contrast > Dynamic**, set the number of measurements to **26**.
- Run the sequence.
- Ensure the drawn prostate boundaries are valid with the new thermometry uncertainty scan before proceeding to Delivery.
- To prepare for Delivery, duplicate the most recent AX THERM sequence with the new coil configuration and in the tab **Contrast > Dynamic**, set the number of measurements to maximum. There should now be at least 90 minutes of available scan time.

Alarm Signals

This section explains how to resolve issues that can interfere with or stop a patient's treatment.



It is important that all users review this section to ensure that patients are not injured accidentally during a troubleshooting process.

Here is what typically occur when the Treatment Delivery Console (TDC) detects a problem:

1. A **condition** is detected that warrants an alarm being raised.
2. The **alarm message** shows on the TDC display.
3. The **TULSA-PRO® System responds** by taking the appropriate action.
4. User **addresses the cause** to resolve the issue.
5. User takes any **additional steps** to resume normal operation.

When an alarm shows on the TDC display, look for the appropriate table in this section to identify how to resolve the problem.

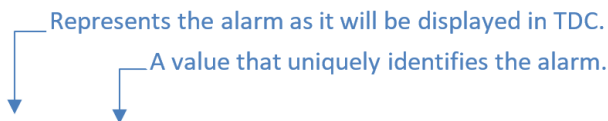

Alarm [00-000]

Condition	Describes why the alarm has been raised.
Error Code	The TDC-generated software-code associated with the condition. This code is used by Profound Medical authorized service representatives in addressing complex issues
Delay	Represents the period of time from when the issue began, to when the alarm was raised.
System Response	Describes the actions that are automatically taken by TDC when the alarm is raised. During treatment, TDC will typically: <ul style="list-style-type: none"> • Pause Treatment – all heating and motion will stop, or • Interrupt Treatment – all heating and motion is stopped, and subsequent thermometry dynamics are ignored.
Address the Cause	Describes the steps required to clear the alarm. When troubleshooting, it is recommended that you try the recommendations in the order they are presented. For example: <ol style="list-style-type: none"> 1. Try this action first. If this does not clear the alarm, then... 2. Try this action.
Steps After Addressing the Cause	Describes any additional steps to continue normal TULSA-PRO® operation.

After resolving the issue, you might need to proceed through the TDC workflow to *Delivery* to start a new treatment segment.

If you can resolve the issue without leaving the *Delivery* workspace, then you need to decide how to proceed:

- **If Treatment is Paused:**
 - i. *Resume Heating* treatment with the current segment.
 - ii. *End Thermometry and Re-plan* the treatment by creating a new segment.
 - iii. *Complete Treatment and View Report* for the current session.
- **If Treatment is Interrupted:**
 - *Resume Heating* treatment with the current segment.
 - *Complete Treatment and View Report* for the current session.

For additional help, contact a Profound Medical authorized service representative as directed in the 'Service and Maintenance' section of the *TULSA-PRO® Instructions For Use*.

C.1. Fluid Cart

40-201: TDC lost a network connection to the System Cart

Condition	The System Cart has lost network connection to the TDC computer.											
Error Code	40-201											
Delay	Immediate											
System Response	<p>Setup: UA & ECD purging will be cancelled. RF test cannot be performed.</p> <p>Alignment, Coarse, Detailed: No system response.</p> <p>Delivery - Initialization: Ablation will not start.</p> <p>Delivery - Ablation: Ablation will be interrupted.</p>											
Address the Cause	<p>At any stage:</p> <ol style="list-style-type: none"> Ensure the thermometry sequence is running on the MRI, and that enough dynamics have been selected for the thermometry scan you are trying to run. <ul style="list-style-type: none"> Philips: 25 dynamics for Detailed, 1200 dynamics minimum for Delivery Ensure the MRI and TDC Computer are still able to communicate through their network connection by checking the status of the MRI subsystem in <i>Setup</i> workspace. Ensure that the appropriate TULSA-PRO® sequence and parameters is being used for thermometry acquisition. 											
Steps After Addressing the Cause	<table border="1"> <tr> <td>SETUP</td> <td rowspan="3">Not applicable.</td> </tr> <tr> <td>ALIGNMENT</td> </tr> <tr> <td>COARSE</td> </tr> <tr> <td>DETAILED</td> <td>Relaunch the MRI Thermometry Sequence on the MRI Console. The alarm will clear once the new image is received.</td> </tr> <tr> <td>DELIVERY - INITIALIZATION</td> <td> <ol style="list-style-type: none"> Click Start on the TDC. Re-enter the patient's core temperature. Relaunch the MRI Thermometry Sequence on the MRI Console. The alarm will clear once the new image is received. </td> </tr> <tr> <td>DELIVERY - ABLATION</td> <td> <ol style="list-style-type: none"> Click End Thermometry and Re-plan on the TDC to create a new Treatment Segment. Stop the MRI Thermometry Sequence on the MRI Console. Click Start on the TDC. Re-enter the patient's core temperature. Relaunch the MRI Thermometry Sequence on the MRI Console. The alarm will clear once the new image is received. </td> </tr> </table>	SETUP	Not applicable.	ALIGNMENT	COARSE	DETAILED	Relaunch the MRI Thermometry Sequence on the MRI Console. The alarm will clear once the new image is received.	DELIVERY - INITIALIZATION	<ol style="list-style-type: none"> Click Start on the TDC. Re-enter the patient's core temperature. Relaunch the MRI Thermometry Sequence on the MRI Console. The alarm will clear once the new image is received. 	DELIVERY - ABLATION	<ol style="list-style-type: none"> Click End Thermometry and Re-plan on the TDC to create a new Treatment Segment. Stop the MRI Thermometry Sequence on the MRI Console. Click Start on the TDC. Re-enter the patient's core temperature. Relaunch the MRI Thermometry Sequence on the MRI Console. The alarm will clear once the new image is received. 	
SETUP	Not applicable.											
ALIGNMENT												
COARSE												
DETAILED	Relaunch the MRI Thermometry Sequence on the MRI Console. The alarm will clear once the new image is received.											
DELIVERY - INITIALIZATION	<ol style="list-style-type: none"> Click Start on the TDC. Re-enter the patient's core temperature. Relaunch the MRI Thermometry Sequence on the MRI Console. The alarm will clear once the new image is received. 											
DELIVERY - ABLATION	<ol style="list-style-type: none"> Click End Thermometry and Re-plan on the TDC to create a new Treatment Segment. Stop the MRI Thermometry Sequence on the MRI Console. Click Start on the TDC. Re-enter the patient's core temperature. Relaunch the MRI Thermometry Sequence on the MRI Console. The alarm will clear once the new image is received. 											

40-202: The cable between the System Cart and the System Electronics has been disconnected

Condition	The cable connecting the System Cart (SC) to the System Electronics (SE) is not connected.
Error Code	40-202
Delay	Immediate
System Response	Setup: UA and ECD purging will be cancelled. RF test cannot be performed. Alignment, Coarse, Detailed: No system response. Delivery - Initialization: Ablation will not start. Delivery - Ablation: Ablation will be interrupted.
Address the cause	At any stage: <ol style="list-style-type: none">1. Ensure the cable is connected between the System Cart to the System Electronics.2. If the alarm still does not clear, unplug the cable from the System Electronics and the System Cart. Re-attach, and wait one minute. Verify if alarm disappears.

Steps After Addressing the Cause	SETUP	<ol style="list-style-type: none">1. Address the cause of the alarm so that the message disappears.2. Perform another UA and ECD purge after the alarm has been resolved.
	ALIGNMENT	Address the cause of the alarm so that the message disappears. Proceed through the normal workflow.
	COARSE	
	DETAILED	
	DELIVERY - INITIALIZATION	<ol style="list-style-type: none">1. Stop the MRI Thermometry Sequence on the MRI Console.2. Address the cause of the alarm so that the message disappears.3. Click Start on the TDC.4. Re-enter the patient's core temperature.5. Relaunch the MRI Thermometry Sequence on the MRI Console.
DELIVERY - ABLATION	<ol style="list-style-type: none">1. Click End Thermometry and Re-plan on the TDC to create a new Treatment Segment.2. Stop the MRI Thermometry Sequence on the MRI Console.3. Address the cause of the alarm so that the message disappears.4. Click Start on the TDC.	

5. Re-enter the patient's core temperature.
 6. Relaunch the MRI Thermometry Sequence on the MRI Console.
-

40-206: The room temperature for the System Cart is too high

Condition	The System Cart temperature is greater than or equal to 37°C
Error Code	40-206
Delay	Immediate
System Response	Setup, Alignment, Coarse, Detailed: No system response. Delivery - Initialization: Ablation will not start. Delivery - Ablation: Ablation will be interrupted.
Address the Cause	Reduce the temperature of the room where the System Cart is located. For example: <ol style="list-style-type: none"> 1. Ensure the air conditioning in the room where the System Cart is located is turned on. 2. Ensure there is air ventilation near the System Cart.

Steps After Addressing the Cause	SETUP	Address the cause of the alarm so that the message disappears. Although the alarm will not prevent you from moving to the next phase of treatment, you will be prevented from performing an ablation.
	ALIGNMENT	
	COARSE	
	DETAILED	
	DELIVERY - INITIALIZATION	<ol style="list-style-type: none"> 1. Stop the MRI Thermometry Sequence on the MRI Console. 2. Address the cause of the alarm so that the message disappears. 3. Click Start on the TDC. 4. Re-enter the patient's core temperature. 5. Relaunch the MRI Thermometry Sequence on the MRI Console.
	DELIVERY - ABLATION	<ol style="list-style-type: none"> 1. Click End Thermometry and Re-plan on the TDC to create a new Treatment Segment. 2. Stop the MRI Thermometry Sequence on the MRI Console. 3. Address the cause of the alarm so that the message disappears. 4. Click Start on the TDC. 5. Re-enter the patient's core temperature. 6. Relaunch the MRI Thermometry Sequence on the MRI Console.

41-107: The Ultrasound Applicator fluid-circuit bag volume is too low

Condition	The volume in the Ultrasound Applicator (UA) circuit is less than or equal to 400 mL.	
Error Code	41-107	
Delay	Immediate	
System Response	<p>Setup: UA purging will be cancelled. RF test cannot be performed.</p> <p>Alignment, Coarse, Detailed: No system response.</p> <p>Delivery - Initialization: Ablation will not start.</p> <p>Delivery - Ablation: Ablation will be interrupted.</p>	
Address the Cause	<p>At any stage:</p> <ol style="list-style-type: none"> 1. Visually inspect the UA tubing, and all Luer Lock connections for leaks between the fluid reservoir, the pump, and the UA. 2. Ensure the UA's fluid reservoir contains a minimum of 500mL of fluid. <ul style="list-style-type: none"> • If necessary, add fluid to the reservoir. <p style="text-align: center;">NOTE: This may require a new 1L Sterile Water Bag to be opened.</p>	
Steps After Addressing the Cause	SETUP	<ol style="list-style-type: none"> 1. Address the cause of the alarm so that the message disappears. 2. Perform another UA purge. 3. After purging, perform an RF Test.
	ALIGNMENT	Address the cause of the alarm so that the message disappears. Proceed through the normal workflow.
	COARSE	
	DETAILED	
	DELIVERY - INITIALIZATION	<ol style="list-style-type: none"> 1. Stop the MRI Thermometry Sequence on the MRI Console. 2. Address the cause of the alarm so that the message disappears. 3. Click Start on the TDC. 4. Re-enter the patient's core temperature. 5. Relaunch the MRI Thermometry Sequence on the MRI Console.
DELIVERY - ABLATION	<ol style="list-style-type: none"> 1. Click End Thermometry and Re-plan on the TDC to create a new Treatment Segment. 2. Stop the MRI Thermometry Sequence on the MRI Console. 3. Address the cause of the alarm so that the message disappears. 4. Click Start on the TDC. 	

C.1. Fluid Cart

5. Re-enter the patient's core temperature.
 6. Relaunch the MRI Thermometry Sequence on the MRI Console.
-

41-109: The Ultrasound Applicator fluid-circuit pump pressure is too low

Condition	<ul style="list-style-type: none"> • Before Ultrasound Applicator (UA) Purging: The UA pressure is less than or equal to 14 psi, with the pump on for at least 20 seconds. • During UA Purging: The UA pressure is less than or equal to 14 psi while the purge cycle has been running for at least 90 seconds. • After UA Purging: The UA pressure is less than or equal to 3 psi, with the pumps on for at least 20 seconds. 	
Error Code	41-109	
Delay	Immediate	
System Response	<p>Setup: UA purging will be cancelled. RF test cannot be performed.</p> <p>Alignment, Coarse, Detailed: No system response.</p> <p>Delivery - Initialization: Initialization stops.</p> <p>Delivery - Ablation: Ablation will be interrupted.</p>	
Address the Cause	<p>At any stage:</p> <ol style="list-style-type: none"> 1. Verify that the UA pressure sensor is connected to the System Cart. 2. Ensure the UA fluid reservoir contains more than 400mL of fluid. This can be checked by looking at the UA Circuit – Volume in the <i>Setup</i> tab of TDC <ul style="list-style-type: none"> • If necessary, add fluid to the reservoir (should be filled to minimum of 500ml). NOTE: <i>This may require a new 1L Sterile Water Bag to be opened.</i> 3. Visually inspect the UA tubing, and all Luer Lock connections for leaks between the fluid reservoir, the pump, and the UA. 4. Check the connection of the UA pressure sensor on the Fluid Cart is properly seated. Remove the UA pressure sensor from the System Electronics, and re-insert, making sure it is fully seated in the connector slot. 	
Steps After Addressing the Cause	SETUP	<ol style="list-style-type: none"> 1. Address the cause of the alarm so that the message disappears. 2. Perform another UA purge. 3. Afterward the purge, perform an RF Test.
	ALIGNMENT	Not applicable.
	COARSE	
	DETAILED	
DELIVERY - INITIALIZATION	<ol style="list-style-type: none"> 1. Stop the MRI Thermometry Sequence on the MRI Console. 2. Address the cause of the alarm so that the message disappears. 3. Click Start on the TDC. 4. Re-enter the patient’s core temperature. 	

	<ol style="list-style-type: none">5. Relaunch the MRI Thermometry Sequence on the MRI Console.
DELIVERY - ABLATION	<ol style="list-style-type: none">1. Click End Thermometry and Re-plan on the TDC to create a new Treatment Segment.2. Stop the MRI Thermometry Sequence on the MRI Console.3. Address the cause of the alarm.4. Click Start on the TDC.5. Re-enter the patient's core temperature.6. Relaunch the MRI Thermometry Sequence on the MRI Console.

41-110: The Ultrasound Applicator fluid-circuit pump pressure is too high

Condition	<ul style="list-style-type: none"> • Before Ultrasound Applicator (UA) Purging: The UA pressure is greater than or equal to 31 psi, with the pump on for at least 20 seconds. • During UA Purging: The UA pressure is greater than or equal to 31 psi while the purge cycle has been running for at least 90 seconds. • After UA Purging: The UA pressure increases by greater than or equal to 6 psi from the average pressure measured during purging, with the pumps on for at least 20 seconds. 										
Error Code	41-110										
Delay	Immediate										
System Response	<p>Setup (purging): UA purging will be cancelled. RF test cannot be performed.</p> <p>Alignment, Coarse, Detailed: No system response.</p> <p>Delivery - Initialization: Ablation will not start.</p> <p>Delivery - Ablation: Ablation will be paused.</p>										
Address the Cause	<p>At any stage:</p> <ol style="list-style-type: none"> 1. Visually inspect the UA tubing for obstructions between the fluid reservoir, the pump, and the UA. For example: <ul style="list-style-type: none"> • Ensure all fluid line clamps near the UA are open. • Ensure the tubing is loaded correctly, and not kinked, in the UA pump roller head. <ul style="list-style-type: none"> • Ensure that the UA tubing is not caught beneath a fluid-cart wheel or any other equipment in the MRI/Technical/Control Rooms. 2. Consider raising the temperature of the room where the System Cart is located. Although <i>uncommon</i>, it is possible for this alarm to occur if the room temperature where the System Cart is located is cold. 										
Steps After Addressing the Cause	<table border="1"> <tr> <td>SETUP</td> <td> <p>If the UA purge has not been completed, perform another UA purge.</p> <p>If the purge has been completed, but the RF test has not yet been completed, initiate the RF test.</p> </td> </tr> <tr> <td>ALIGNMENT</td> <td rowspan="3">Not applicable.</td> </tr> <tr> <td>COARSE</td> </tr> <tr> <td>DETAILED</td> </tr> <tr> <td>DELIVERY - INITIALIZATION</td> <td rowspan="2">Click Resume Heating on the TDC to resume treatment.</td> </tr> <tr> <td>DELIVERY - ABLATION</td> </tr> </table>	SETUP	<p>If the UA purge has not been completed, perform another UA purge.</p> <p>If the purge has been completed, but the RF test has not yet been completed, initiate the RF test.</p>	ALIGNMENT	Not applicable.	COARSE	DETAILED	DELIVERY - INITIALIZATION	Click Resume Heating on the TDC to resume treatment.	DELIVERY - ABLATION	
SETUP	<p>If the UA purge has not been completed, perform another UA purge.</p> <p>If the purge has been completed, but the RF test has not yet been completed, initiate the RF test.</p>										
ALIGNMENT	Not applicable.										
COARSE											
DETAILED											
DELIVERY - INITIALIZATION	Click Resume Heating on the TDC to resume treatment.										
DELIVERY - ABLATION											

42-107: The ECD fluid-circuit bag volume is too low

Condition	The volume in the ECD circuit is less than or equal to 400 mL.	
Error Code	42-107	
Delay	Immediate	
System Response	<p>Setup: ECD purging will be cancelled. RF test cannot be performed.</p> <p>Alignment, Coarse, Detailed: No system response.</p> <p>Delivery - Initialization: Ablation will not start.</p> <p>Delivery - Ablation: Ablation will be interrupted.</p>	
Address the Cause	<p>At any stage:</p> <ol style="list-style-type: none"> Inspect the ECD fluid line and all in-line Luer Lock connections for leaks between the fluid reservoir, the pump, and the ECD. Ensure that the ECD fluid reservoir contains a minimum of 500mL of fluid <ul style="list-style-type: none"> If additional fluid is required in the fluid reservoir, ensure a correlated amount of MnCl and Span/Tween is also added to the fluid reservoir. NOTE: This may require a new Span/Tween and MnCl bottle and 1L Sterile Water Bag to be opened. 	
Steps After Addressing the Cause	SETUP	<ol style="list-style-type: none"> Address the cause of the alarm so that the message disappears. Perform another ECD purge.
	ALIGNMENT	Address the cause of the alarm so that the message disappears. Proceed through the normal workflow.
	COARSE	
	DETAILED	
	DELIVERY - INITIALIZATION	<ol style="list-style-type: none"> Stop the MRI Thermometry Sequence on the MRI Console. Address the cause of the alarm so that the message disappears. Click Start on the TDC. Re-enter the patient's core temperature. Relaunch the MRI Thermometry Sequence on the MRI Console.
DELIVERY - ABLATION	<ol style="list-style-type: none"> Click End Thermometry and Re-plan on the TDC to create a new Treatment Segment. Stop the MRI Thermometry Sequence on the MRI Console. Address the cause of the alarm so that the message disappears. Click Start on the TDC. Re-enter the patient's core temperature. 	

6. Relaunch the MRI Thermometry Sequence on the MRI Console.

42-109: The ECD fluid-circuit pump pressure is too low

Condition	<ul style="list-style-type: none"> During ECD Purging: The ECD pressure is less than or equal to 13 psi after the purging cycle is completed. During normal operation: The ECD pressure is less than or equal to 13 psi, with the pumps on for at least 20 seconds. 	
Error Code	42-109	
Delay	Immediate	
System Response	<p>Setup: ECD purging will be cancelled.</p> <p>Alignment, Coarse, Detailed: No system response.</p> <p>Delivery - Initialization: Ablation will not start.</p> <p>Delivery - Ablation: Ablation will be interrupted.</p>	
Address the Cause	<p>At any stage:</p> <ol style="list-style-type: none"> Verify the ECD pressure sensor is connected to the System Cart. Visually inspect the ECD fluid line for leaks between the fluid reservoir, the pump, and the ECD. Ensure that the ECD fluid reservoir contains a minimum of 500mL of fluid. If additional fluid is required in the fluid reservoir, ensure a correlated amount of MnCl and Span/Tween is also added to the water at the same time. <i>NOTE: This may require a new Span/Tween and MnCl bottle and 1L Sterile Water Bag to be opened.</i> Check the connection of the ECD pressure sensor on the Fluid Cart. Remove the ECD pressure sensor, and re-insert, making sure it is fully seated in the connector slot. 	
Steps After Addressing the Cause	SETUP	<ol style="list-style-type: none"> Address the cause of the alarm so that the message disappears. Perform another ECD purge after the alarm has been resolved.
	ALIGNMENT	Address the cause of the alarm so that the message disappears. Proceed through the normal workflow.
	COARSE	
	DETAILED	
	DELIVERY - INITIALIZATION	<ol style="list-style-type: none"> Stop the MRI Thermometry Sequence on the MRI Console. Address the cause of the alarm so that the message disappears. Click Start on the TDC. Re-enter the patient's core temperature. Relaunch the MRI Thermometry Sequence on the MRI Console.
DELIVERY -	<ol style="list-style-type: none"> Click End Thermometry and Re-plan on the TDC to create a new 	

ABLATION	Treatment Segment. <ol style="list-style-type: none">2. Stop the MRI Thermometry Sequence on the MRI Console.3. Address the cause of the alarm so that the message disappears.4. Click Start on the TDC.5. Re-enter the patient's core temperature.6. Relaunch the MRI Thermometry Sequence on the MRI Console.
----------	---

42-110: The ECD fluid-circuit pump pressure is too high

Condition	<ul style="list-style-type: none"> • During ECD Purging: The ECD pressure is greater than or equal to 37 psi after the purging cycle is completed. • During normal operation: The ECD pressure is greater than or equal to 37 psi, with the pumps on for at least 20 seconds. 	
Error Code	42-110	
Delay	Immediate	
System Response	<p>Setup: ECD purging will be cancelled.</p> <p>Alignment, Coarse, Detailed: No system response.</p> <p>Delivery - Initialization: Ablation will not start.</p> <p>Delivery - Ablation: Ablation will be paused.</p>	
Address the Cause	<p>At any stage:</p> <ol style="list-style-type: none"> 1. Visually inspect the ECD tubing for obstructions between the fluid reservoir, the pump, and the ECD. For example: <ul style="list-style-type: none"> • Ensure all fluid line clamps near the ECD are open. • Ensure the fluid tubing is loaded correctly, and not kinked, in the ECD pump head. • Ensure that the ECD tubing is not caught beneath a fluid cart wheel or any other equipment in the MRI/Technical/Control Rooms 2. Ensure the ECD fluid and additives are adequately mixed in the ECD reservoir. 3. Consider raising the temperature of the room where the System Cart is located. <p>Although <u>uncommon</u>, it is possible for this alarm to be raised if the room temperature where the System Cart is located is cold.</p>	
Steps After Addressing the Cause	SETUP	<ol style="list-style-type: none"> 1. Address the cause of the alarm until the message disappears. 2. Perform another ECD purge after the alarm has been resolved.
	ALIGNMENT	Address the cause of the alarm so that the message disappears. Proceed through the normal workflow.
	COARSE	
	DETAILED	
DELIVERY - INITIALIZATION	<ol style="list-style-type: none"> 1. Click Stop Initialization on the TDC. 2. Stop the MRI Thermometry Sequence on the MRI Console. 3. Address the cause of the alarm so that the message disappears. 4. Click Start on the TDC. 5. Re-enter the patient's core temperature. 	

C.1. Fluid Cart

	6. Relaunch the MRI Thermometry Sequence on the MRI Console.
DELIVERY - ABLATION	<ol style="list-style-type: none">1. Address the cause of the alarm so that the message disappears.2. Click Resume Heating on the TDC to resume treatment.

C.2. Magnetic Resonance Imaging

50-201: The IP address or port for the MRI cartridge is wrong or in use

Condition	The IP Address and Port specified by the MRI cartridge is being used by another program.
Error Code	50-201
Delay	Immediate
System Response	At any stage, the TDC will not receive thermometry images from the MRI.
Address the Cause	<p>At any stage:</p> <ul style="list-style-type: none"> ▪ Close the TDC application and reboot the TDC computer. ▪ Ensure that no other MRI client computer is turned on. ▪ Contact your on-site IT support team for assistance: ▪ Ensure no additional programs have been installed on the TDC which are trying to communicate with the MRI Host ▪ Open <i>Maintenance Mode</i> in TDC and ensure the appropriate <i>MRI Configuration</i> values are being used.
Steps After Addressing the Cause	Proceed through the normal workflow.

50-202: TDC lost network connection to the MRI

Condition	The TDC has lost the network connection to the MRI.
Error Code	50-202
Delay	Immediate
System Response	<p>Setup, Alignment, Coarse: User cannot load a SAG T2 image.</p> <p>Detailed: User cannot load AX T2 images. TDC will not be able to receive TUV images.</p> <p>Delivery - Initialization: It will not be possible to start initialization or initialization will stop.</p> <p>Delivery - Ablation: Ablation will be interrupted.</p>
Address the Cause	<p>At any stage:</p> <ol style="list-style-type: none"> 1. Ensure the TDC computer is connected to the appropriate switch via an Ethernet cable. 2. Ping from the TDC Computer to the MRI Host and verify there is a network connection. 3. Unplug the Ethernet cable connecting the TDC to the switch, reconnect, and wait one minute before continuing. 4. If all else fails, reboot the MRI.
Steps After Addressing the Cause	At any stage, proceed through the normal workflow.

50-203: There is a delay in receiving the thermometry image

Condition	The thermometry image is being received slower than normal (longer than typical 5-6 seconds).
Error Code	50-203
Delay	1.3x MR sampling period
System Response	Setup, Alignment, Coarse: No system response. Detailed: TDC will stop processing thermometry images from the MRI Delivery - Initialization: Ablation will not start. Delivery - Ablation: Ablation will be paused.

Address the Cause	At any stage: <ol style="list-style-type: none"> 1. Ensure that the TDC application and the MRI host has access to enough computer resources by terminating all non-essential programs or operations such as anti-virus programs, Windows Updates, web browsers, or image querying. 2. <i>For Philips MRI's, ensure both TDC and MRI host are isolated from the main hospital network. To verify, try exporting the planning image to PACS and verify if it fails.</i> 3. Ensure that the appropriate TULSA-PRO® sequence and parameters is being used for thermometry acquisition.
-------------------	---

Steps After Addressing the Cause	SETUP	Not applicable.
	ALIGNMENT	
	COARSE	
	DETAILED	<ol style="list-style-type: none"> 1. Stop the MRI. 2. Re-launch the Thermometry sequence with the appropriate dynamic number. The alarm will clear when the next thermometry scan is received.
	DELIVERY - INITIALIZATION	<ol style="list-style-type: none"> 1. Stop initialization and the MRI. 2. Click Start on the TDC. 3. Re-enter the patient's core temperature. 4. Relaunch the MRI Thermometry Sequence on the MRI Console.
DELIVERY - ABLATION	<ol style="list-style-type: none"> 1. Click Resume Heating to resume treatment. The alarm will clear when the next thermometry scan is received. 	

50-204: TDC has not received new thermometry images in the last 30 seconds

Condition	A new thermometry image has not been received in the last 30 seconds or so.
Error Code	50-204
Delay	5x MR sampling period
System Response	Setup, Alignment, Coarse: No system response. Detailed: TDC will stop processing thermometry images from the MRI Delivery - Initialization: TDC will stop processing thermometry images from the MRI and Initialization will be terminated. Delivery - Ablation: Ablation will be interrupted.

Address the Cause	At any stage: <ol style="list-style-type: none"> 1. Ensure the thermometry sequence is running on the MRI, and that sufficient dynamics have been selected for the thermometry scan you are trying to run. <ul style="list-style-type: none"> ◦ Philips: 25 dynamics for Detailed, 1200 dynamics minimum for Delivery ◦ Philips: 26 dynamics for Detailed, 1200 dynamics minimum for Delivery 2. Ensure the MRI and TDC computer are still able to communicate through their network connection by checking the status of the MRI subsystem in <i>Setup</i> workspace. 3. Ensure that the appropriate TULSA-PRO® sequence and parameters is being used for thermometry acquisition.
-------------------	---

Steps After Addressing the Cause	SETUP	Not applicable.
	ALIGNMENT	
	COARSE	
	DETAILED	Relaunch the MRI Thermometry Sequence on the MRI Console. The alarm will clear once the new image is received.
	DELIVERY - INITIALIZATION	<ol style="list-style-type: none"> 1. Click Start on the TDC. 2. Re-enter the patient's core temperature. 3. Relaunch the MRI Thermometry Sequence on the MRI Console. The alarm will clear once the new image is received.
	DELIVERY - ABLATION	<ol style="list-style-type: none"> 1. Click End Thermometry and Re-plan on the TDC to create a new Treatment Segment. 2. Stop the MRI Thermometry Sequence on the MRI Console. 3. Click Start on the TDC. 4. Re-enter the patient's core temperature. 5. Relaunch the MRI Thermometry Sequence on the MRI Console. The alarm will clear once the new image is received.

50-209: The thermometry images cannot be used

Condition	The thermometry images have become corrupted and can no longer be used. Patient motion or an MRI artifact is suspected.
Error Code	50-209
Delay	Immediate
System Response	Setup, Alignment, Coarse: Not applicable. Condition and alarm will not occur. Detailed: TDC will stop processing thermometry images from the MRI Delivery – Initialization: TDC will stop processing thermometry images from the MRI and Initialization will be terminated. Delivery – Ablation: Ablation will be interrupted.

Address the Cause	At any stage: <ol style="list-style-type: none"> 1. Check magnitude THERM images for tissue displacement outside of the treatment volume (e.g. bladder filling, bowel movement, gas). 2. Ensure the patient has not moved during Delivery. Consult with the anesthesiologist to confirm the patient has received the correct medication, dosage, and the timing of drug administration. Anesthesiologist will decide if a top up medication is necessary. 3. Ensure there is no RF noise in the MRI images (for example, non-MRI Compatible equipment in the technical room, intermittent electrical connection) 4. Check the magnitude THERM images for phase wrap in the A>P direction. <p>The alarm will clear once new thermometry images are received.</p>
-------------------	---

Steps After Addressing the Cause	SETUP	Not applicable.	
	ALIGNMENT		
	COARSE		
	DETAILED	Acquire a new thermometry scan.	
	DELIVERY - INITIALIZATION	<ol style="list-style-type: none"> 1. Click Start on the TDC. 2. Re-enter the patient’s core temperature. 3. Relaunch the MRI Thermometry Sequence on the MRI Console. The alarm will clear once the new image is received. 	
	DELIVERY - ABLATION	<p>If you suspect any patient motion, tissue motion, bladder filling, bowel gas or bowel movement:</p> <ol style="list-style-type: none"> 1. Click End Thermometry and Re-plan. 2. Return to <i>Alignment</i>. 3. Unlock the UA. 4. Re-acquire a new SAG T2 Image. 	<p>If the source of MRI noise was RF:</p> <ol style="list-style-type: none"> 1. Click End Thermometry and Re-plan. 2. Return to <i>Detailed Planning</i>. 3. Re-acquire a new TUV. 4. Proceed through the normal workflow to <i>Delivery</i>.

5. Proceed through the normal workflow to *Delivery*.

In either situation, the alarm will clear after you click **End Thermometry and Re-plan**.

50-211: The thermometry scan does not match the prescribed image position or orientation

Condition	There is a disagreement between where the thermometry scan was acquired and where the TDC thinks the thermometry scan should have been acquired.
Error Code	50-211
Delay	Immediate
System Response	Setup, Alignment, Coarse: No system response. Detailed: TDC will stop processing thermometry images from the MRI Delivery - Initialization: TDC will stop processing thermometry images from the MRI and Initialization will be terminated. Delivery - Ablation: Not applicable.

Address the Cause Ensure that thermometry position & orientation information for the thermometry scan to the MRI have been correctly setup.
NOTE: This Alarm only appears when using TULSA-PRO® with a Siemens MRI.

Steps After Addressing the Cause	SETUP	Not applicable.
	ALIGNMENT	
	COARSE	
	DETAILED	<p>Confirm the last Scan run on the MRI is the same as the last Scan imported into TDC Coarse Planning.</p> <p style="text-align: center;"><i>1. If not done correctly:</i></p> <ol style="list-style-type: none"> 1. Import the latest SAG T2 in the <i>Alignment Planning</i> tab of TDC. 2. If necessary, adjust the UA Position by selecting Unlock UA. Proceed through the normal workflow. 3. Open the THERM scan on the MRI Software. 4. Copy the Table Position from the most recent SAG T2 Scan acquired. 5. Click Update in <i>Detailed Planning</i>. 6. Set the number of dynamics to 1. 7. Run the thermometry sequence. 8. Repeat the sequence, changing the number of dynamics 26. 9. Ensure the coils activated between the Reference Scan (1 dynamic) and the larger dynamic scan are identical. <p>The alarm will clear when the images with the correct THERM position and orientation is received.</p>
DELIVERY - INITIALIZATION	<ol style="list-style-type: none"> 1. Open the THERM scan on the Siemens MRI Software. 2. Copy the Table Position from the most recent SAG T2 Scan 	

	<p>acquired.</p> <ol style="list-style-type: none"> 3. Click Update in <i>Delivery</i> workspace. 4. Set the number of dynamics to 1. 5. Run the thermometry sequence. 6. Repeat the sequence, changing the number of dynamics to the maximum available. 7. Ensure the coils activated between the Reference Scan (1 dynamic) and the larger dynamic scan are identical. 8. Click Start on the TDC. 9. Re-enter the patient's core temperature. 10. Relaunch the MRI Thermometry Sequence on the MRI Console. The alarm will clear once the new image is received.
DELIVERY - ABLATION	Not applicable.

50-212: Someone changed the thermometry sequence parameters and they are out of range

Condition	The thermometry sequence parameters have been modified and are no longer the default value.
Error Code	50-212
Delay	Immediate
System Response	Setup, Alignment, Coarse: No system response. Detailed: TDC will stop processing thermometry images from the MRI Delivery - Initialization: TDC will stop processing thermometry images from the MRI and Initialization will be terminated. Delivery - Ablation: Not applicable.

Address the Cause At any stage:

1. Reload the sequence from the exam card to restore original default values.
2. If the problem continues, contact a Profound Medical authorized service representative.

Steps After Addressing the Cause	SETUP	Not applicable.
	ALIGNMENT	
	COARSE	
	DETAILED	Re-run the MRI Sequence. The alarm will clear once the first image from the correct sequence is received.
	DELIVERY - INITIALIZATION	
	DELIVERY - ABLATION	Not applicable.

50-213: The thermometry images cannot be used

Condition	The image shift calculated after 100 dynamics is greater than 1 mm in the frequency-encoding direction or 2 mm in the phase-encoding direction for any slice.
Error Code	50-213
Delay	Every 100 imaging dynamics
System Response	Setup, Alignment, Coarse, Detailed, Delivery - Initialization: No system response. Delivery – Ablation: Ablation will be interrupted.
Address the Cause	At any stage: <ol style="list-style-type: none"> 1. Check magnitude THERM images for tissue displacement outside of the treatment volume (e.g. bladder filling, bowel movement, gas). 2. Ensure the patient has not moved during Delivery. Consult with the anesthesiologist to confirm the patient has received the correct medication, dosage, and the timing of drug administration. Anesthesiologist will decide if a top up medication is necessary. 3. Ensure there is no RF noise in the MRI images (for example, non-MRI Compatible equipment in the technical room, intermittent electrical connection) 4. Check the magnitude THERM images for phase wrap in the A>P direction. <p>The alarm will clear once new thermometry images are received.</p>

Steps After Addressing the Cause	SETUP		
	ALIGNMENT	Not applicable.	
	COARSE		
	DETAILED	Acquire a new thermometry scan.	
	DELIVERY - INITIALIZATION	<ol style="list-style-type: none"> 1. Click Start on the TDC. 2. Re-enter the patient’s core temperature. 3. Relaunch the MRI Thermometry Sequence on the MRI Console. The alarm will clear once the new image is received. 	
	DELIVERY - ABLATION	<p>If you suspect any patient motion, tissue motion, bladder filling, bowel gas or bowel movement:</p> <ol style="list-style-type: none"> 1. Click End Thermometry and Re-plan. 2. Return to <i>Alignment</i>. 3. Unlock the UA. 4. Re-acquire a new SAG T2 Image. 5. Proceed through the normal workflow to <i>Delivery</i>. 	<p>If the source of MRI noise was RF:</p> <ol style="list-style-type: none"> 1. Click End Thermometry and Re-plan. 2. Return to <i>Detailed Planning</i>. 3. Re-acquire a new TUV. 4. Proceed through the normal workflow to <i>Delivery</i>.

In either situation, the alarm will clear once you click **End Thermometry and Re-plan**.

50-214: The anatomy scan required for alignment is older than 2 hours.

Condition	Only when not in Delivery - Ablation : The SAG T2 treatment planning image used to establish the Ultrasound Applicator (UA) position cannot be trusted. A new SAG T2 image is required to confirm the location of the UA in the MRI Image.
Error Code	50-214
Delay	Immediate
System Response	Setup, Alignment, Coarse, Detailed : No system response. Delivery – Initialization : It will not be possible to start initialization. Delivery – Ablation : Not applicable. Condition and alarm will not occur.
Address the Cause	<ol style="list-style-type: none"> 1. Unlock the <i>Alignment</i> workspace, acquire a new SAG T2 Scan, and then import it into the TDC. 2. Realign if necessary. NOTE: If you need to realign, then you will be forced to acquire new TUV and AX T2 scans during Detailed planning. <p>The alarm will clear once the new SAG T2 image is loaded into the TDC.</p>

Steps After Addressing the Cause	SETUP	Not applicable.
	ALIGNMENT	Continue through the normal workflow.
	COARSE	
	DETAILED	
	DELIVERY - INITIALIZATION	
	DELIVERY - ABLATION	Not applicable.

50-215: Check that the patient is in a head-first, supine position

Condition	The Patient Orientation is not head-first, supine and was set incorrectly during patient registration.									
Error Code	50-215									
Delay	Immediate									
System Response	<p>Setup, Alignment, Coarse: No system response.</p> <p>Detailed: TDC will stop processing thermometry images from the MRI</p> <p>Delivery – Initialization: TDC will stop processing thermometry images from the MRI and Initialization will be terminated.</p> <p>Delivery – Ablation: Not applicable. Condition and alarm will not occur.</p>									
Address the Cause	The patient will need to be re-registered on the MRI console with the correct Patient Position Orientation (Head First – Supine) or the MRI configuration will need to be adjusted.									
Steps After Addressing the Cause	<table border="1"> <tr> <td>SETUP</td> <td rowspan="5">Continue through the normal workflow.</td> </tr> <tr> <td>ALIGNMENT</td> </tr> <tr> <td>COARSE</td> </tr> <tr> <td>DETAILED</td> </tr> <tr> <td>DELIVERY - INITIALIZATION</td> </tr> <tr> <td>DELIVERY - ABLATION</td> <td>Not applicable.</td> </tr> </table>	SETUP	Continue through the normal workflow.	ALIGNMENT	COARSE	DETAILED	DELIVERY - INITIALIZATION	DELIVERY - ABLATION	Not applicable.	
SETUP	Continue through the normal workflow.									
ALIGNMENT										
COARSE										
DETAILED										
DELIVERY - INITIALIZATION										
DELIVERY - ABLATION	Not applicable.									

C.3. Positioning System

10-102: TDC lost the network connection to the Positioning System Interface Box

Condition	The Positioning System Interface Box (PSIB) network connection has been lost and the TDC can no longer communicate with the PSIB.													
Error Code	10-102													
Delay	Immediate													
System Response	<p>Setup: User will not be able to proceed to Alignment.</p> <p>Alignment: No system response.</p> <p>Coarse: User will not be able to translate the Ultrasound Applicator (UA) with the robotic linear axis.</p> <p>Detailed: User will not be able to rotate the UA with the robotic rotational axis. User can still proceed to Delivery.</p> <p>Delivery - Initialization: Ablation will not start.</p> <p>Delivery - Ablation: Ablation will be paused.</p>													
Address the Cause	<p>At any stage:</p> <ol style="list-style-type: none"> 1. Ensure the System Electronics (SE) is plugged into a power outlet and the power switch is turned ON. Verify if the connection is re-established. 2. Ensure there is an Ethernet cable connecting the TDC to the SE. Verify if the connection is re-established. 3. Ensure both RF cables (System Electronics-to-Filter Box and Filter Box-to-PSIB) are connected. Check that the connection is re-established. 4. Unplug the Ethernet cable connecting the TDC to the SE, reconnect, and wait one minute before continuing. Verify if the connection is re-established. 5. Turn the SE power off. Disconnect the white RF cable at the PSIB, wait one minute, and re-connect. Turn on the SE power. Verify if the connection is re-established. 													
Steps After Addressing the Cause	<table border="1"> <tr> <td>SETUP</td> <td>Proceed through the normal workflow.</td> </tr> <tr> <td>ALIGNMENT</td> <td>Check if the UA rotational axis is still homed. If homing was lost, repeat the UA homing procedure in the <i>Setup</i> workspace. Proceed through the normal workflow.</td> </tr> <tr> <td>COARSE</td> <td>Perform the required linear move of the UA with the robotic linear axis (if needed) and proceed to the <i>Detailed Planning</i>.</td> </tr> <tr> <td>DETAILED</td> <td>Check if the UA rotational axis is still homed. If homing was lost, repeat the UA homing procedure in the <i>Setup</i> workspace. Proceed through the normal workflow.</td> </tr> <tr> <td>DELIVERY - INITIALIZATION</td> <td>Check if the UA rotational axis is still homed. If homing was lost, repeat the UA homing procedure in the <i>Setup</i> workspace. Proceed through the normal workflow.</td> </tr> <tr> <td>DELIVERY - ABLATION</td> <td>Click Resume Heating on the TDC to resume treatment.</td> </tr> </table>	SETUP	Proceed through the normal workflow.	ALIGNMENT	Check if the UA rotational axis is still homed. If homing was lost, repeat the UA homing procedure in the <i>Setup</i> workspace. Proceed through the normal workflow.	COARSE	Perform the required linear move of the UA with the robotic linear axis (if needed) and proceed to the <i>Detailed Planning</i> .	DETAILED	Check if the UA rotational axis is still homed. If homing was lost, repeat the UA homing procedure in the <i>Setup</i> workspace. Proceed through the normal workflow.	DELIVERY - INITIALIZATION	Check if the UA rotational axis is still homed. If homing was lost, repeat the UA homing procedure in the <i>Setup</i> workspace. Proceed through the normal workflow.	DELIVERY - ABLATION	Click Resume Heating on the TDC to resume treatment.	
SETUP	Proceed through the normal workflow.													
ALIGNMENT	Check if the UA rotational axis is still homed. If homing was lost, repeat the UA homing procedure in the <i>Setup</i> workspace. Proceed through the normal workflow.													
COARSE	Perform the required linear move of the UA with the robotic linear axis (if needed) and proceed to the <i>Detailed Planning</i> .													
DETAILED	Check if the UA rotational axis is still homed. If homing was lost, repeat the UA homing procedure in the <i>Setup</i> workspace. Proceed through the normal workflow.													
DELIVERY - INITIALIZATION	Check if the UA rotational axis is still homed. If homing was lost, repeat the UA homing procedure in the <i>Setup</i> workspace. Proceed through the normal workflow.													
DELIVERY - ABLATION	Click Resume Heating on the TDC to resume treatment.													

20-102: The cable between the Positioning System (PS) and PS Interface Box is disconnected

Condition	The Positioning System (PS) cable is disconnected from the PS Interface Box (PSIB).									
Error Code	20-102									
Delay	Immediate									
System Response	<p>Setup: User will not be able to Test PS or Home UA</p> <p>Alignment: No system response.</p> <p>Coarse: User will not be able to adjust the linear position of UA with the robotic linear axis.</p> <p>Detailed: No system response.</p> <p>Delivery - Initialization: It will not be possible to start initialization or initialization will stop.</p> <p>Delivery - Ablation: Ablation will be interrupted.</p>									
Address the Cause	At any stage, verify the PS cable is firmly seated in the PSIB. Verify if the connection is restored. If it still does not show a connection, remove the PS cable, wait one minute, and then re-insert.									
Steps After Addressing the Cause	<table border="1"> <tr> <td>SETUP</td> <td>Proceed through the normal workflow.</td> </tr> <tr> <td>ALIGNMENT</td> <td> <ol style="list-style-type: none"> 1. Return to <i>Setup</i>. 2. Unlock UA. 3. Home the UA. 4. Load the latest SAG T2 image acquired into Alignment. 5. Align the UA. 6. Proceed through the normal workflow. </td> </tr> <tr> <td>COARSE</td> <td> <ol style="list-style-type: none"> 1. Return to <i>Setup</i>. 2. Unlock the UA. 3. Home the UA. 4. Load the latest SAG T2 image acquired into <i>Alignment</i>. The UA will be auto-registered by the software. 5. Select Register UA. 6. Proceed through the normal workflow. </td> </tr> <tr> <td>DETAILED</td> <td> <ol style="list-style-type: none"> 1. Return to <i>Setup</i>. 2. Unlock the UA. 3. Home the UA. 4. Load the latest SAG T2 image acquired into Alignment. The UA will be auto-registered by the software. 5. Select Register UA. Do not move the UA in <i>Coarse Planning</i>; instead, select Accept Position. 6. Proceed through the normal workflow. </td> </tr> </table>	SETUP	Proceed through the normal workflow.	ALIGNMENT	<ol style="list-style-type: none"> 1. Return to <i>Setup</i>. 2. Unlock UA. 3. Home the UA. 4. Load the latest SAG T2 image acquired into Alignment. 5. Align the UA. 6. Proceed through the normal workflow. 	COARSE	<ol style="list-style-type: none"> 1. Return to <i>Setup</i>. 2. Unlock the UA. 3. Home the UA. 4. Load the latest SAG T2 image acquired into <i>Alignment</i>. The UA will be auto-registered by the software. 5. Select Register UA. 6. Proceed through the normal workflow. 	DETAILED	<ol style="list-style-type: none"> 1. Return to <i>Setup</i>. 2. Unlock the UA. 3. Home the UA. 4. Load the latest SAG T2 image acquired into Alignment. The UA will be auto-registered by the software. 5. Select Register UA. Do not move the UA in <i>Coarse Planning</i>; instead, select Accept Position. 6. Proceed through the normal workflow. 	
SETUP	Proceed through the normal workflow.									
ALIGNMENT	<ol style="list-style-type: none"> 1. Return to <i>Setup</i>. 2. Unlock UA. 3. Home the UA. 4. Load the latest SAG T2 image acquired into Alignment. 5. Align the UA. 6. Proceed through the normal workflow. 									
COARSE	<ol style="list-style-type: none"> 1. Return to <i>Setup</i>. 2. Unlock the UA. 3. Home the UA. 4. Load the latest SAG T2 image acquired into <i>Alignment</i>. The UA will be auto-registered by the software. 5. Select Register UA. 6. Proceed through the normal workflow. 									
DETAILED	<ol style="list-style-type: none"> 1. Return to <i>Setup</i>. 2. Unlock the UA. 3. Home the UA. 4. Load the latest SAG T2 image acquired into Alignment. The UA will be auto-registered by the software. 5. Select Register UA. Do not move the UA in <i>Coarse Planning</i>; instead, select Accept Position. 6. Proceed through the normal workflow. 									

<p>DELIVERY - INITIALIZATION</p>	<ol style="list-style-type: none"> 1. Return to <i>Setup</i>. 2. Unlock the UA. 3. Home the UA. 4. Load the latest SAG T2 image acquired into Alignment. The UA will be auto-registered by the software. 5. Select Register UA. 6. Do not move the UA in <i>Coarse Planning</i>; instead, select Accept Position. 7. Confirm treatment planning. You will not need to re-acquire new TUV or AX T2 images. 8. Proceed through the normal workflow.
<p>DELIVERY - ABLATION</p>	<ol style="list-style-type: none"> 1. Click End Thermometry and Re-plan. 2. Return to <i>Setup</i>. 3. Unlock the UA. 4. Home the UA. 5. Load the latest SAG T2 image acquired into Alignment. The UA will be auto-registered by the software. 6. Select Register UA. 7. Do not move the UA in <i>Coarse Planning</i>; instead, select Accept Position. 8. Confirm treatment planning. You will not need to re-acquire new TUV or AX T2 images. 9. Proceed through the normal workflow.

20-201: There is a problem with the rotary motion

Condition	A rotary motion fault occurred.
Error Code	20-201
Delay	Immediate
System	Setup: PS Test or Rotary Home will stop.
Response	Alignment, Coarse: Not applicable. Condition and alarm will not occur. Detailed: The Ultrasound Applicator (UA) will not reach the intended starting position. Delivery - Initialization: Not applicable. Condition and alarm will not occur. Delivery - Ablation: Ablation will be paused.

Address the Cause	At any stage: 1. Ensure nothing is preventing the Positioning System (PS) from rotating the UA freely. Possible causes include: <ul style="list-style-type: none"> ▪ The UA and/or ECD fluid lines have become wrapped around the PS. ▪ One of fluid lines are impeded by table drapes or other accessories. ▪ The UA cable is too tight and is not allowing the UA to rotate freely. 2. To remove tension from the UA cable, disconnect the UA cable at the PSIB end, un-wind the cable, and then re-connect it.
-------------------	--

Steps After Addressing the Cause	SETUP	Proceed through the normal workflow.
	ALIGNMENT	Not applicable.
	COARSE	
	DETAILED	Re-attempt the rotary motion. Proceed through the normal workflow.
	DELIVERY - INITIALIZATION	
	DELIVERY - ABLATION	Click Resume Heating on the TDC. The alarm will clear and treatment will resume.

20-202: The TDC computer is busy and cannot process thermometry images fast enough

Condition	The Positioning System (PS) is receiving new hardware commands slower than usual, because TDC is not processing images fast enough.									
Error Code	20-202									
Delay	8 seconds									
System Response	<p>Setup, Alignment, Coarse, Detailed, Delivery - Initialization: Not applicable. Condition and alarm will not occur.</p> <p>Delivery - Ablation: Ablation will be paused.</p>									
Address the Cause	At any stage, ensure that the TDC has access to enough computer resources by closing all non-essential programs, such as antivirus programs, Windows Updates, or web browsers.									
Steps After Addressing the Cause	<table border="1"> <tr> <td>SETUP</td> <td rowspan="5">Not applicable.</td> </tr> <tr> <td>ALIGNMENT</td> </tr> <tr> <td>COARSE</td> </tr> <tr> <td>DETAILED</td> </tr> <tr> <td>DELIVERY - INITIALIZATION</td> </tr> <tr> <td>DELIVERY - ABLATION</td> <td>Click Resume Heating on the TDC. The alarm will clear and treatment will resume.</td> </tr> </table>	SETUP	Not applicable.	ALIGNMENT	COARSE	DETAILED	DELIVERY - INITIALIZATION	DELIVERY - ABLATION	Click Resume Heating on the TDC. The alarm will clear and treatment will resume.	
SETUP	Not applicable.									
ALIGNMENT										
COARSE										
DETAILED										
DELIVERY - INITIALIZATION										
DELIVERY - ABLATION	Click Resume Heating on the TDC. The alarm will clear and treatment will resume.									

20-203: Something went wrong with the Positioning System communications

Condition	There was a Positioning System Interface Box (PSIB) communication failure with a motion controller, which has stopped motion.							
Error Code	20-203							
Delay	Immediate							
System Response	Setup, Alignment, Coarse, Detailed: No system response. Delivery - Ablation: Ablation will be paused. Delivery – Initialization: Ablation will not start.							
Address the Cause	At any stage, the TDC automatically corrects the issue. You do not need to perform any action.							
Steps After Addressing the Cause	<table border="1"> <tr><td>SETUP</td></tr> <tr><td>ALIGNMENT</td></tr> <tr><td>COARSE</td></tr> <tr><td>DETAILED</td></tr> <tr><td>DELIVERY - INITIALIZATION</td></tr> <tr><td>DELIVERY - ABLATION</td></tr> </table>	SETUP	ALIGNMENT	COARSE	DETAILED	DELIVERY - INITIALIZATION	DELIVERY - ABLATION	<p>Not applicable.</p> <p>Click Resume Heating on the TDC. The alarm will clear and treatment will resume.</p>
SETUP								
ALIGNMENT								
COARSE								
DETAILED								
DELIVERY - INITIALIZATION								
DELIVERY - ABLATION								

21-201: The Positioning System's linear axis moved unexpectedly

Condition	The Positioning System (PS) linear axis has unexpectedly moved and the Ultrasound Applicator (UA) is no longer registered to the MRI Image.
Error Code	21-201
Delay	Immediate
System Response	Setup, Alignment, Coarse, Detailed: No system response. Delivery - Initialization: It will not be possible to start initialization or initialization will stop. Delivery - Ablation: Ablation will be interrupted.
Address the Cause	At any stage, the automated linear axis has unexpectedly moved from its last-requested linear position. The UA is no longer registered to the MRI Image. <ol style="list-style-type: none"> 1. Ensure that there is no additional force being applied on the robotic linear axis of the PS. 2. Ensure the patient is not moving.

Steps After Addressing the Cause	SETUP	Not applicable.
	ALIGNMENT	<ol style="list-style-type: none"> 1. Re-acquire a new SAG T2. 2. From the Anatomy selector, select the new SAG T2 to align the UA a second time. The alarm will clear once the new SAG T2 image has been acquired. 3. Proceed through the normal workflow to return to <i>Delivery</i>.
	COARSE	<ol style="list-style-type: none"> 1. Unlock the UA in the <i>Alignment</i> tab. 2. Re-acquire a new SAG T2.
	DETAILED	<ol style="list-style-type: none"> 3. Go to the Anatomy selector and select the new SAG T2 to align the UA a second time. The alarm will clear once the new image is acquired.
	DELIVERY - INITIALIZATION	<ol style="list-style-type: none"> 4. Proceed through the normal workflow to return to <i>Delivery</i>.
DELIVERY - ABLATION	<ol style="list-style-type: none"> 1. Create a new segment. 2. Unlock the UA in the <i>Alignment</i> tab. 3. Re-acquire a new SAG T2. 4. Go to the Anatomy selector and select the new SAG T2 to align the UA a second time. The alarm will clear once the new image is acquired. 5. Proceed through the normal workflow to return to <i>Delivery</i>. 	

22-201: The Positioning System is not rotating the Ultrasound Applicator at the expected rate

Condition	The Positioning System (PS) is not rotating the Ultrasound Applicator (UA) at the expected rate.
Error Code	22-201
Delay	Immediate
System Response	Setup, Alignment, Coarse, Detailed, Delivery - Initialization: Not applicable. Condition and alarm will not occur. Delivery - Ablation: Ablation will be paused.

Address the Cause	At any stage: <ol style="list-style-type: none"> 1. Ensure nothing is preventing the PS from rotating the UA freely. Possible reasons include: <ul style="list-style-type: none"> • The UA and/or ECD fluid lines have become wrapped around the PS. • One of the fluid lines is impeded by table drapes or other accessories. 2. The UA cable is too tight and not allowing the UA to rotate freely. <ul style="list-style-type: none"> • To remove tension from the UA cable, disconnect the UA cable at the PSIB end, un-wind the cable, and then re-connect it. 3. Although <u>uncommon</u>, the alarm could be raised due to malfunctioning hardware. If you continue to receive this alarm, contact PMI support.
-------------------	--

Steps After Addressing the Cause	SETUP	Not applicable.
	ALIGNMENT	
	COARSE	
	DETAILED	
	DELIVERY - INITIALIZATION	
	DELIVERY - ABLATION	Click Resume Heating on the TDC. The alarm will clear and treatment will resume.

22-202: The rotary home position has been lost

Condition	The Ultrasound Applicator (UA) is not properly seated in the Positioning System (PS) gripper or the PS Interface Box (PSIB) lost power, which caused the known position to be lost.
Error Code	22-202
Delay	Immediate
System Response	Setup, Alignment, Coarse: No system response. Detailed: User will not be able to rotate the UA with the robotic rotational axis. User can still proceed to Delivery. Delivery - Initialization: It will not be possible to start initialization or initialization will stop. Delivery - Ablation: Ablation will be interrupted.

Address the Cause	At any stage: <ol style="list-style-type: none"> 1. Ensure the UA is properly seated within the PS gripper. If necessary, open the PS Gripper and reattach the UA. 2. Ensure that the PS can communicate with the PSIB by checking the UA attached status in the <i>Setup</i> workspace. If necessary, unplug the cable connecting the PS to the PSIB, reconnect, and wait one minute.
-------------------	--

Steps After Addressing the Cause	SETUP	Not applicable.
	ALIGNMENT	1. Navigate to the <i>Setup</i> workspace and select Unlock UA . Home the UA. The alarm will clear.
	COARSE	If the UA became disengaged from the PS:
	DETAILED	1. Acquire a new SAG T2 scan.
	DELIVERY - INITIALIZATION	2. Load the latest SAG T2 sequence in the Anatomy selector. 3. Proceed through the normal workflow.
	DELIVERY - ABLATION	1. Create a new segment. 2. Navigate to the <i>Setup</i> workspace and select Unlock UA . 3. Home the UA. The alarm will clear. If UA became disengaged from PS: 1. Acquire a new SAG T2 scan. 2. Load the latest SAG T2 sequence in the Anatomy selector. 3. Proceed through the normal workflow.

22-206: The Ultrasound Applicator (UA) has rotated too far in one direction

Condition	The Ultrasound Application (UA) has rotated too far in one direction. The UA must be unwound to proceed with heating.													
Error Code	22-206													
Delay	Immediate													
System Response	<p>Setup, Alignment, Coarse, Detailed: No system response.</p> <p>Delivery – Initialization: It will not be possible to start initialization.</p> <p>Delivery - Ablation: Ablation will be paused.</p>													
Address the Cause	<p>In Delivery: The UA has rotated too far in one direction. Clicking the <i>Unwind UA</i> button will unwind the UA. Once it has finished unwinding, it allows you to continue treatment in the same treatment direction.</p> <p>In Initialization: Using the <i>Delivery</i> workspace, manually move the center position of the UA slightly on the THERM TUV magnitude. The TDC application will recognize that it has reached the UA rotation limit and will take the necessary steps to correct the problem.</p>													
Steps After Addressing the Cause	<table border="1"> <tr> <td>SETUP</td> <td>Not applicable.</td> </tr> <tr> <td>ALIGNMENT</td> <td>Not applicable.</td> </tr> <tr> <td>COARSE</td> <td>Not applicable.</td> </tr> <tr> <td>DETAILED</td> <td>Not applicable.</td> </tr> <tr> <td>DELIVERY - INITIALIZATION</td> <td>Not applicable.</td> </tr> <tr> <td>DELIVERY - ABLATION</td> <td> <ol style="list-style-type: none"> 1. Click Unwind UA to unwind the UA. 2. Once the unwinding procedure has completed, click Resume Heating to proceed with treatment. The alarm will clear once the UA has finished unwinding. </td> </tr> </table>		SETUP	Not applicable.	ALIGNMENT	Not applicable.	COARSE	Not applicable.	DETAILED	Not applicable.	DELIVERY - INITIALIZATION	Not applicable.	DELIVERY - ABLATION	<ol style="list-style-type: none"> 1. Click Unwind UA to unwind the UA. 2. Once the unwinding procedure has completed, click Resume Heating to proceed with treatment. The alarm will clear once the UA has finished unwinding.
SETUP	Not applicable.													
ALIGNMENT	Not applicable.													
COARSE	Not applicable.													
DETAILED	Not applicable.													
DELIVERY - INITIALIZATION	Not applicable.													
DELIVERY - ABLATION	<ol style="list-style-type: none"> 1. Click Unwind UA to unwind the UA. 2. Once the unwinding procedure has completed, click Resume Heating to proceed with treatment. The alarm will clear once the UA has finished unwinding. 													

22-208: The Positioning System's rotary axis moved unexpectedly

Condition	The Positioning System (PS) rotary axis has unexpectedly moved and the UA beam may point in an unintended direction.							
Error Code	22-208							
Delay	Immediate							
System Response	<p>Setup, Alignment, Coarse, Detailed: No system response.</p> <p>Delivery - Initialization: It will not be possible to start initialization.</p> <p>Delivery - Ablation: Not applicable. Condition and alarm will not occur.</p>							
Address the Cause	<p>At any stage, the automated rotary axis has unexpectedly moved from its last-requested rotary position.</p> <ol style="list-style-type: none"> 1. Ensure that there is no additional force being applied on the robotic rotary axis of the PS. 2. Ensure the patient is not moving. 							
Steps After Addressing the Cause	<table border="1"> <tr> <td>SETUP</td> <td rowspan="5"> Repeat the PS rotary homing procedure in the <i>Setup</i> workspace. <ol style="list-style-type: none"> 1. Navigate to the <i>Setup</i> workspace and select Unlock UA. 2. Perform PS rotary homing again. 3. Proceed through the normal workflow. </td> </tr> <tr> <td>ALIGNMENT</td> </tr> <tr> <td>COARSE</td> </tr> <tr> <td>DETAILED</td> </tr> <tr> <td>DELIVERY - INITIALIZATION</td> </tr> </table>	SETUP	Repeat the PS rotary homing procedure in the <i>Setup</i> workspace. <ol style="list-style-type: none"> 1. Navigate to the <i>Setup</i> workspace and select Unlock UA. 2. Perform PS rotary homing again. 3. Proceed through the normal workflow. 	ALIGNMENT	COARSE	DETAILED	DELIVERY - INITIALIZATION	
SETUP	Repeat the PS rotary homing procedure in the <i>Setup</i> workspace. <ol style="list-style-type: none"> 1. Navigate to the <i>Setup</i> workspace and select Unlock UA. 2. Perform PS rotary homing again. 3. Proceed through the normal workflow. 							
ALIGNMENT								
COARSE								
DETAILED								
DELIVERY - INITIALIZATION								

C.4. Radio Frequency

30-201: Emergency switch button has been activated

Condition	Someone pressed the emergency switch on the System Electronics.
Error Code	30-201
Delay	Immediate
System Response	<p>Setup: Linear and rotary axes will turn off, ultrasound power for all elements will turn off, UA and ECD fluid pumps will turn off.</p> <p>Alignment: No system response.</p> <p>Coarse: User can not adjust the UA linear position with the robotic linear axis.</p> <p>Detailed: User can not adjust the UA rotational position with the robotic rotational axis.</p> <p>Delivery - Initialization: It will not be possible to start initialization or initialization will stop.</p> <p>Delivery - Ablation: Ablation will be interrupted.</p>
Address the Cause	<p>At any stage:</p> <ol style="list-style-type: none"> 1. Resolve the situation that required the emergency button to be pushed. 2. To clear the alarm, press-and-hold the emergency switch button, located on the front side of the SE, for five seconds.
Steps After Addressing the Cause	At any stage, proceed through the normal workflow.

30-202: The TDC computer is busy and cannot process thermometry images fast enough

Condition	The System Electronics (SE) have not received a new power-update command in the last 8 seconds, because the TDC is not processing images fast enough.										
Error Code	30-202										
Delay	8 seconds										
System Response	<p>Setup, Alignment, Coarse, Detailed: Not applicable. Condition and alarm will not occur.</p> <p>Delivery-Initialization: Ablation will not start.</p> <p>Delivery - Ablation: Ablation will be paused.</p>										
Address the Cause	At any stage, ensure that the TDC application has enough computer resources by terminating all non-essential programs, such as antivirus programs, Windows Updates, and web browsers.										
Steps After Addressing the Cause	<table border="1"> <tr> <td>SETUP</td> <td rowspan="4">Not applicable.</td> </tr> <tr> <td>ALIGNMENT</td> </tr> <tr> <td>COARSE</td> </tr> <tr> <td>DETAILED</td> </tr> <tr> <td>DELIVERY - INITIALIZATION</td> <td>When the Resume Heating button is available on the TDC, click it to continue treatment.</td> </tr> <tr> <td>DELIVERY - ABLATION</td> <td>Continue treatment.</td> </tr> </table>	SETUP	Not applicable.	ALIGNMENT	COARSE	DETAILED	DELIVERY - INITIALIZATION	When the Resume Heating button is available on the TDC, click it to continue treatment.	DELIVERY - ABLATION	Continue treatment.	
SETUP	Not applicable.										
ALIGNMENT											
COARSE											
DETAILED											
DELIVERY - INITIALIZATION	When the Resume Heating button is available on the TDC, click it to continue treatment.										
DELIVERY - ABLATION	Continue treatment.										

31-201: The System Electronics amplifiers are overheating

Condition	One or more amplifiers inside the System Electronics (SE) are overheating.
Error Code	31-201
Delay	Immediate
System Response	Setup, Alignment, Coarse, Detailed: No system response. Delivery - Initialization: It will not be possible to start initialization or initialization will stop. Delivery - Ablation: Ablation will be interrupted.

Address the Cause	At any stage: <ol style="list-style-type: none"> 1. Ensure the front and rear vents on the SE are unobstructed and the fans are running. Allow the amplifiers to cool before continuing. 2. Consider moving the SE (without disconnecting the SE power cable or fluid tubes), to a more open space in the room to maximize airflow. 3. Consider decreasing the temperature in the room where the SE is located.
-------------------	--

Steps After Addressing the Cause	SETUP	Not applicable.
	ALIGNMENT	
	COARSE	
	DETAILED	
	DELIVERY - INITIALIZATION	<ol style="list-style-type: none"> 1. Stop the MRI Thermometry Sequence on the MRI Console. 2. Click Start on the TDC. 3. Re-enter the patient's core temperature. 4. Relaunch the MRI Thermometry Sequence on the MRI Console.
	DELIVERY - ABLATION	<ol style="list-style-type: none"> 1. Click End Thermometry and Re-plan on the TDC to create a new Treatment Segment. 2. Stop the MRI Thermometry Sequence on the MRI Console. 3. Click Start on the TDC. 4. Re-enter the patient's core temperature. 5. Relaunch the MRI Thermometry Sequence on the MRI Console.

31-202: The System Electronics amplifiers have turned off

Condition	One or more amplifiers inside the System Electronics (SE) have switched off unexpectedly.										
Error Code	31-202										
Delay	Immediate										
System Response	<p>Setup, Alignment, Coarse, Detailed: Not applicable. Condition and alarm will not occur.</p> <p>Delivery – Initialization: Ablation will not start.</p> <p>Delivery - Ablation: Ablation will be paused.</p>										
Address the Cause	Ensure the TDC application has enough computer resources by terminating all non-essential programs, such as antivirus programs, Windows Updates, and web browsers.										
Steps After Addressing the Cause	<table border="1"> <tr> <td>SETUP</td> <td rowspan="4">Not applicable.</td> </tr> <tr> <td>ALIGNMENT</td> </tr> <tr> <td>COARSE</td> </tr> <tr> <td>DETAILED</td> </tr> <tr> <td>DELIVERY - INITIALIZATION</td> <td>Once the Resume Heating button is available on the TDC, click it to continue treatment.</td> </tr> <tr> <td>DELIVERY - ABLATION</td> <td>Continue treatment.</td> </tr> </table>	SETUP	Not applicable.	ALIGNMENT	COARSE	DETAILED	DELIVERY - INITIALIZATION	Once the Resume Heating button is available on the TDC, click it to continue treatment.	DELIVERY - ABLATION	Continue treatment.	
SETUP	Not applicable.										
ALIGNMENT											
COARSE											
DETAILED											
DELIVERY - INITIALIZATION	Once the Resume Heating button is available on the TDC, click it to continue treatment.										
DELIVERY - ABLATION	Continue treatment.										

32-102: TDC lost the network connection to the System Electronics

Condition	The System Electronics (SE) network connection has been lost.	
Error Code	32-102	
Delay	Immediate	
System Response	<p>Setup: UA and ECD purging will be cancelled. RF test cannot be performed.</p> <p>Alignment, Coarse, Detailed: No system response.</p> <p>Delivery - Initialization: It will not be possible to start initialization or initialization will stop.</p> <p>Delivery - Ablation: Ablation will be interrupted.</p>	
Address the Cause	<p>At any stage:</p> <ol style="list-style-type: none"> 1. Ensure the SE is plugged into a power outlet and the power switch is turned ON. Verify if the connection is re-established. 2. Ensure there is an Ethernet cable connecting the TDC to the SE. Verify if the connection is re-established. 3. Unplug the Ethernet cable connecting the TDC to the SE, reconnect, and wait one minute. Verify if the connection is re-established. 4. Consider replacing the Ethernet cable that connects the TDC to the SE. 	
Steps After Addressing the Cause	SETUP	<p>If the UA purge has <u>not</u> been completed, perform another UA purge.</p> <p>If the purge has been completed, but the RF test has not yet been completed, initiate the RF test.</p>
	ALIGNMENT	Proceed through the normal workflow.
	COARSE	
	DETAILED	
	DELIVERY - INITIALIZATION	<ol style="list-style-type: none"> 1. Stop the MRI Thermometry Sequence on the MRI Console. 2. Click Start on the TDC. 3. Re-enter the patient's core temperature. 4. Relaunch the MRI Thermometry Sequence on the MRI Console.
DELIVERY - ABLATION	<ol style="list-style-type: none"> 1. Click End Thermometry and Re-plan on the TDC to create a new Treatment Segment. 2. Stop the MRI Thermometry Sequence on the MRI Console. 3. Click Start on the TDC. 4. Re-enter the patient's core temperature. 5. Relaunch the MRI Thermometry Sequence on the MRI Console. The alarm will clear once the new image is received. 	

C.5. System

71-202: There is not enough hard-drive storage space to complete this session

Condition	There is not enough storage space on the TDC hard drive. At least 6 GB of space are required.
Error Code	71-202
Delay	Immediate
System Response	Setup, Alignment, Coarse, Detailed: No system response. Delivery - Initialization: Ablation will not start. Delivery - Ablation: Ablation will be paused.
Address the Cause	Contact an authorized Profound Medical service representative.
Steps After Addressing the Cause	At any stage, follow the instructions from the authorized Profound Medical service representative.